

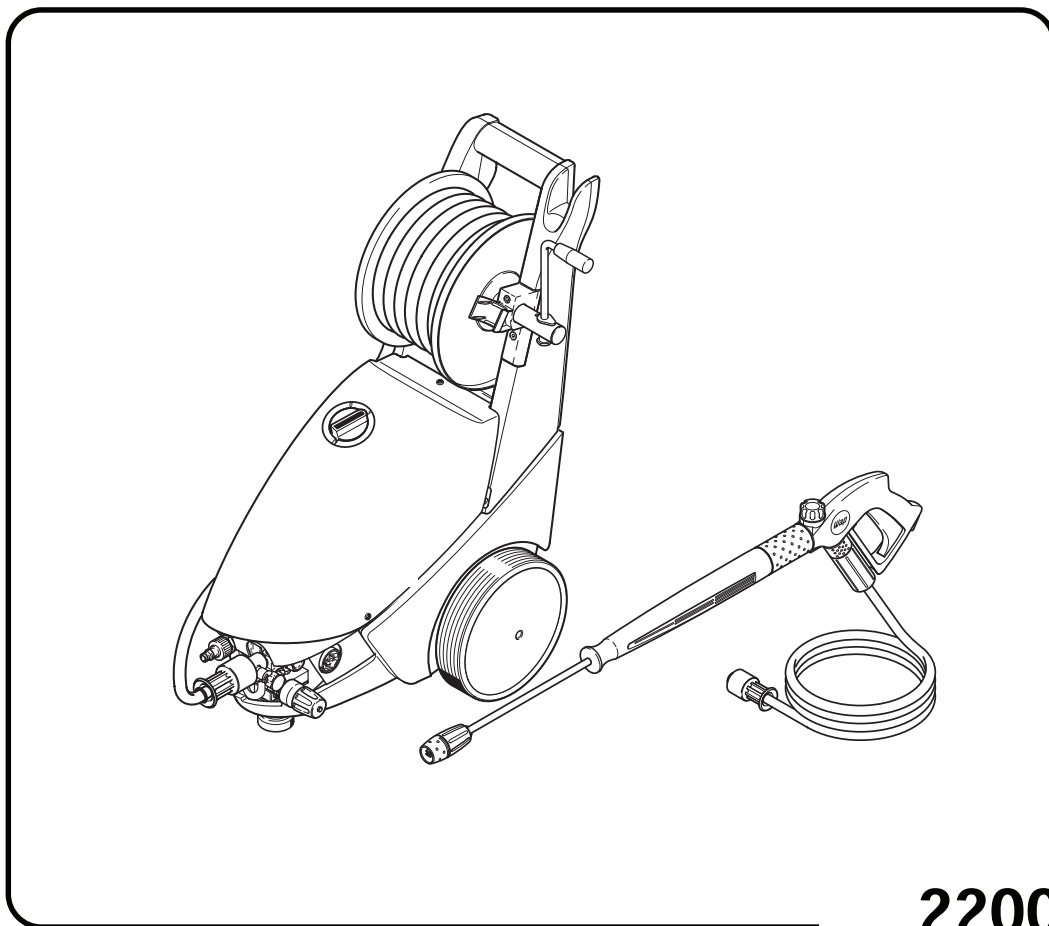

Ersatzteilliste
Spare Parts List
Pièces détachées



2200
2200 W
3300
Silver
Silver W

61233
020898

2200
2200W
3300
Silver
Silver W

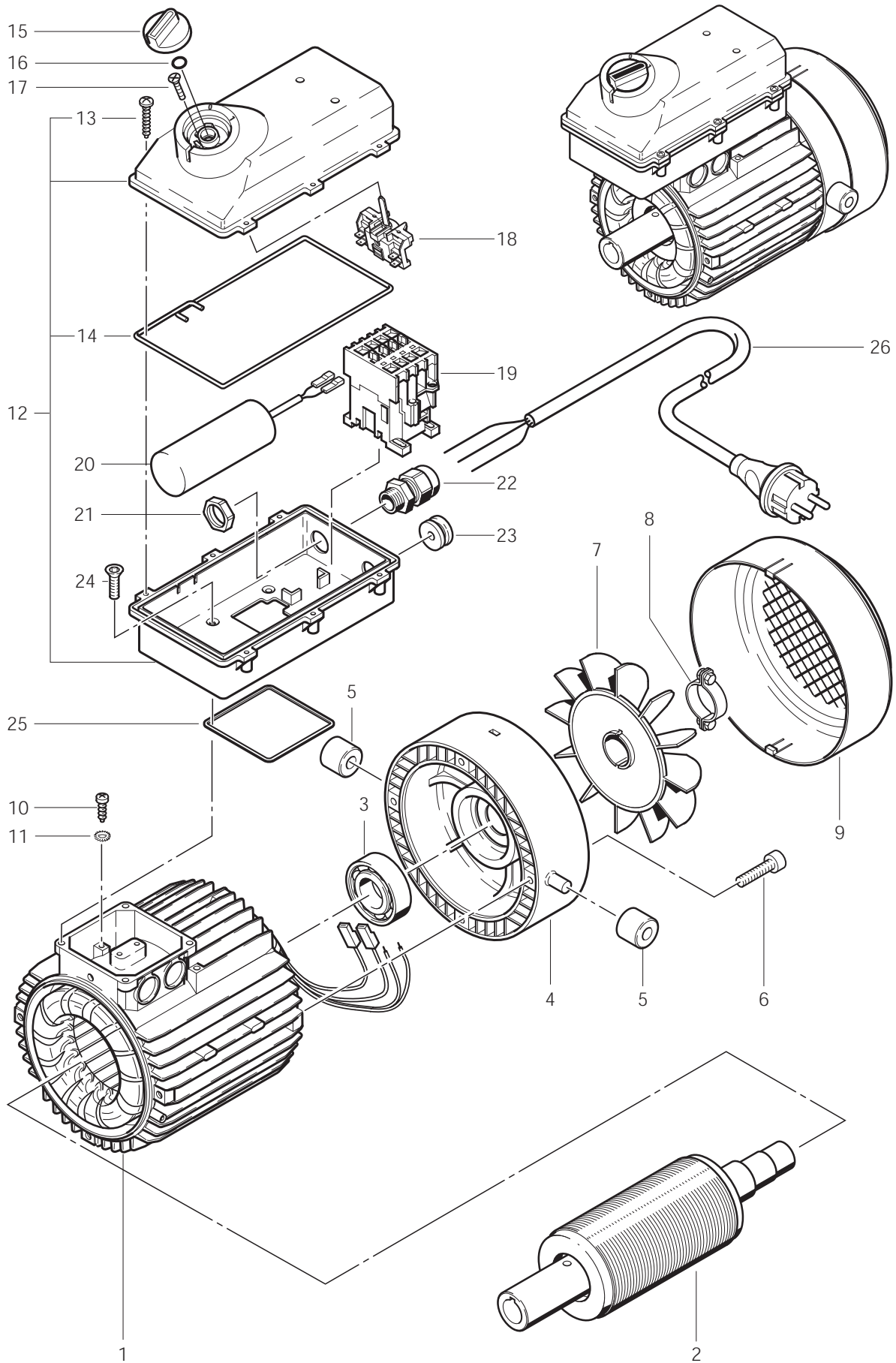

POS.	NO.	BEZEICHNUNG	DESCRIPTION	DESIGNATION	2200 2200W 3300 Silver Silver W
1	61053	Stator 5,5kW 230/400V/50Hz bei Wap 3300			
	61056	Stator 5,0kW 230/400V/50Hz bei Wap 2200, Silver*EU*			
	61058	Stator 2,3kW 230V/1/50Hz bei Wap 2200 W, Silver W*GB*			
2	61060	Rotor bei Wap 2200 W, Silver W*GB*			
	61057	Rotor bei Wap 2200, Silver*EU*			
	61054	Rotor bei Wap 3300			
3	40918	Rillenkugellager 6206-2RS	GROOVE BALL BEARING		
4	61061	Lagerdeckel			
5	26608	Buchse D30x20			
6		Zyl. Schraube M 6x 25	Socket head cap screw M6x25	Vis cylindrique M6x25	DIN 91
7	61062	Lüfterrad			
8	61572	Klemmbügel			
9	61063	Lüfterhaube			
10	8822	Schraube Bl- 3,5x 9,5	Sheet metal screw 3,5x9,5	DI Vis autotaraudeuse 3,5x9,5	D
11		Fächerscheibe A 4,3	Serrated lock washer A4,3	DI Rondelle évantail A4,3	DIN 67
12	61099	Schaltkasten			
13	16861	Schraube KA40x20	Screw PT 4x20	Vis autotaraudeuse PT 4x20	
◇	14	50896	Dichtschnur D4	Packing	Joint
15	243606	Drehknopf	Turning knob	Bouton	
16	9868	O-Ring 10,0 x2,5	O-Ring 10x2,5	Joint torique 10x2,5	
17	18274	Schraube Senk- M 4x 12	Countersunk screw M4x12	DI Vis à tête fraisée M4x12	DIN 9
18	29931	Schalter	Switch	Interrupteur	
19	25405	Luftschütz 230V bei Wap 2200 W, Silver W*GB*	Contacteur 230V/50-60Hz 7,5	Contacteur electromag. 230V	
	25413	Schütz 400V/50Hz bei Wap 2200, Wap 3300, Silver*EU*			
20	61303	Kondensator 80µF bei Wap 2200 W, Silver W*GB*			
21	17346	Mutter PG 16 bis Mai 1998	Hexagon nut PG16	Ecrou 6 pans PG16	
	17345	Mutter PG 13,5 ab Juni 1998	Hexagon nut PG 13,5	Ecrou 6 pans PG 13,5	
22	17349	Kabelverschraubung PG 13,5 ab Juni 1998	Cable gland PG 13,5	Raccord à vis pour câbles PG	
	17350	Kabelverschraubung PG 16 bis Mai 1998	Cable gland PG 16	Raccord à vis pour câbles PG	
◇	ACHTUNG! - Meterware - Bitte bei Bestellung gewünschte Länge angeben!				
◇	ATTENTION! - Lengths in metres - Please indicate required length when ordering!				
◇	ATTENTION! - Longueurs par mètre - Préciser la longueur à la commande!				

2200
2200W
3300
Silver
Silver W

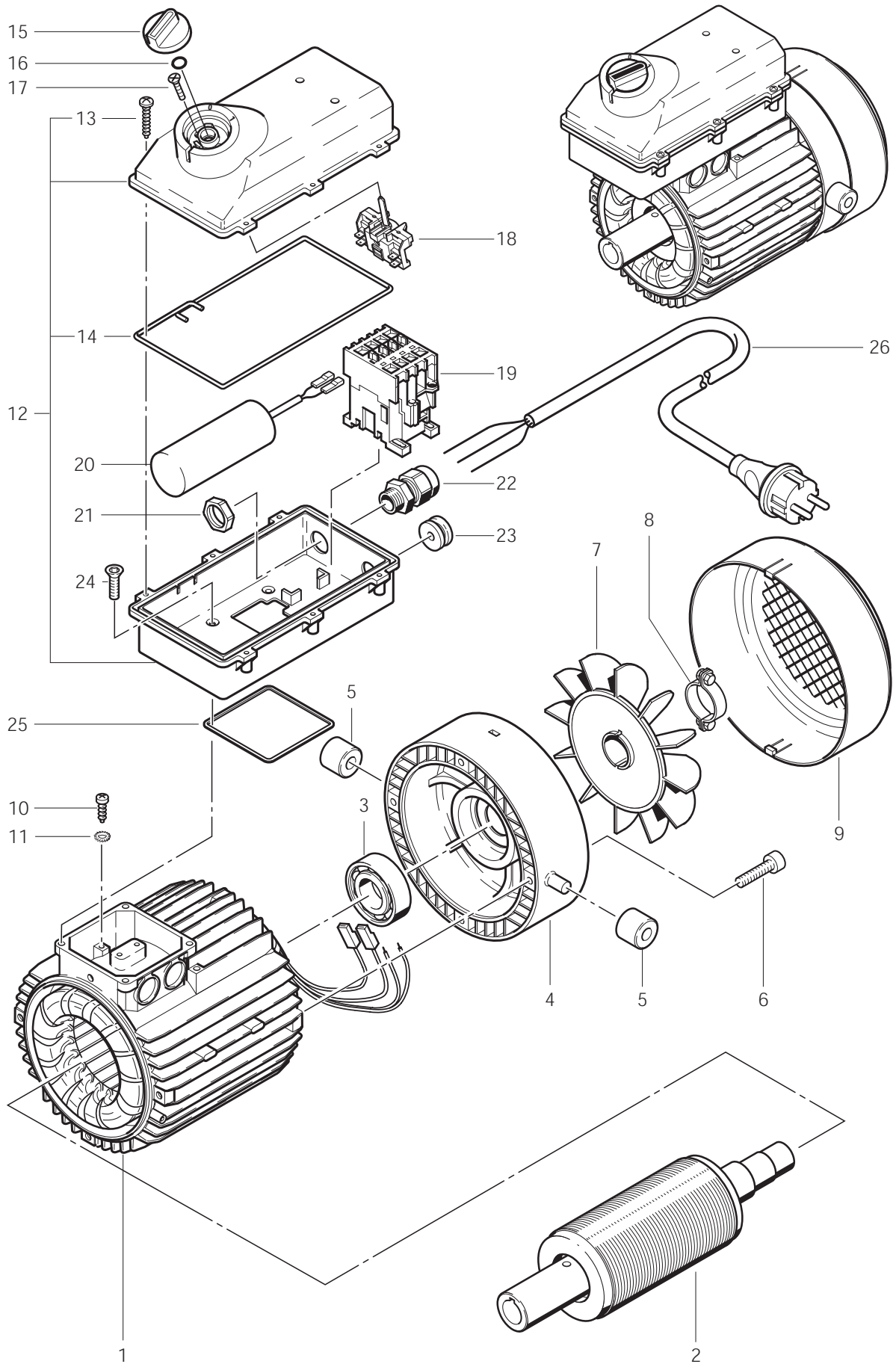

POS.	NO.	BEZEICHNUNG	DESCRIPTION	DESIGNATION
23	60270	Durchführungstülle	Cable bushing	Passe-fil
24	30346	Schraube Senk- M 5x 12	Countersunk screw M5x12	Vis à tête fraisée M5x12
25	29932	Dichtung	Packing	Joint
26	29007	Anschlußleitung bei Wap 2200, Wap 3300 -ohne Stecker-	Power cable	Câble électrique
	29052	Anschlußleitung bei Wap 2200, Wap 3300 -ohne Stecker-	Power cable	Câble électrique
	32024	Anschlußleitung *AUS* bei Wap 2200 W *AU*	CONNECTING CABLE	CABLE ELECTRIQUE
	57065	Anschlußleitung bei Wap 2200 W*GB*, Silver W*GB*	Power cable	Câble électrique
	27072	Anschlußleitung bei Wap 2200, Wap 3300 *FR*	Power cable	Câble électrique
	10440	Anschlußleitung bei Wap 2200 W *CH*	Power cable	Câble électrique
	11156	Anschlußleitung bei Wap 2200W *EURO*	Power cable	Câble électrique
	14503	Anschlußleitung bei Wap 2200 W*ZA*	Power cable	Câble électrique
	14917	Anschlußleitung bei Wap 2200, Wap 3300*EURO*, Silver*EU*	Power cable	Câble électrique

2200
2200W
3300
Silver
Silver W

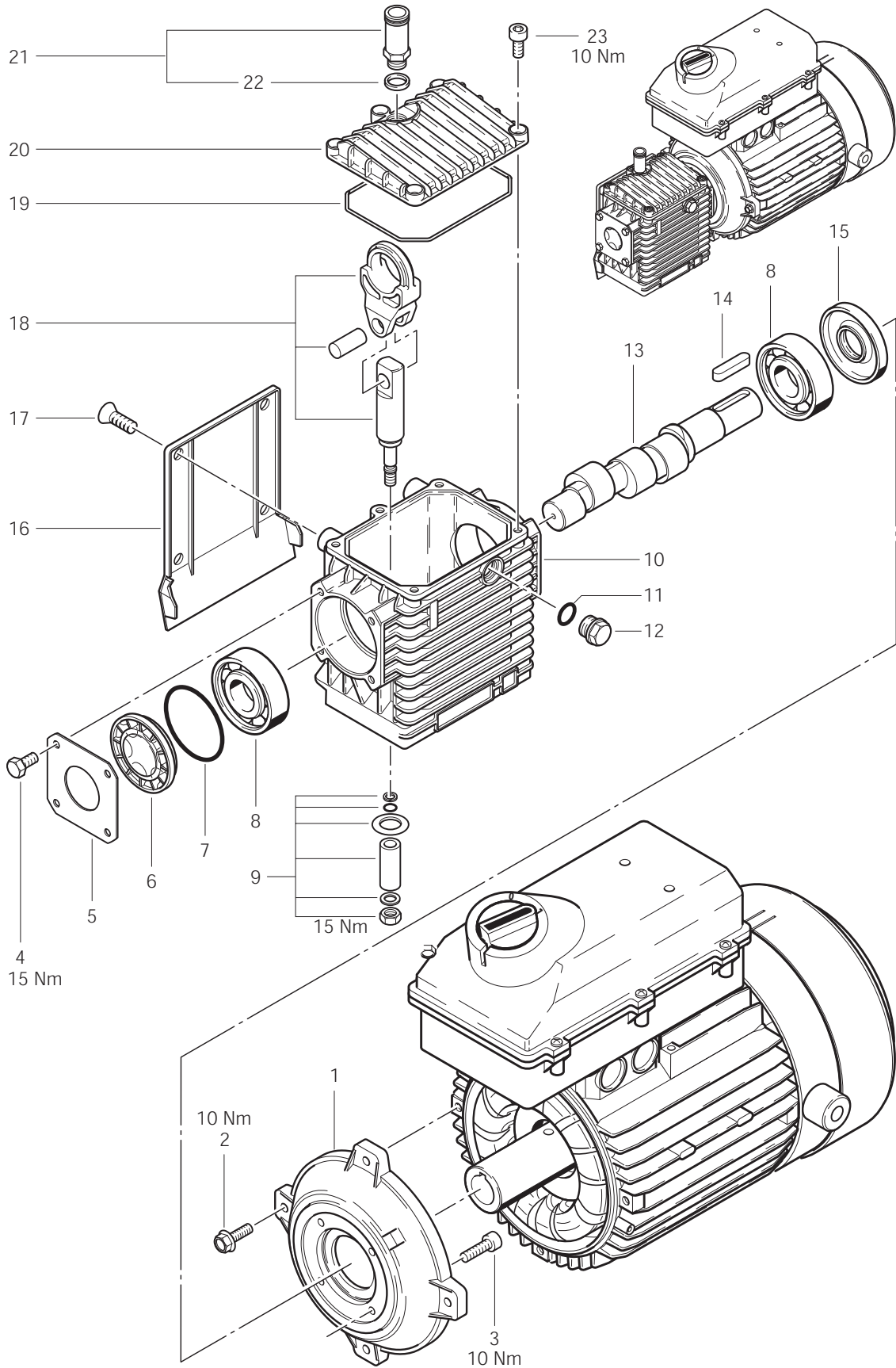

POS.	NO.	BEZEICHNUNG	DESCRIPTION	DESIGNATION
1	61064	Lagerdeckel		
2		Skt. Schraube M 6x 25		
3		Zyl. Schraube M 6x 25	Socket head cap screw M6x25	Vis cylindrique M6x25 DIN 91
4		Sechskantschraube M6x10 DIN 93	Hexagon cap screw M6x10	Vis 6 pans M6x10 DIN 933
5	61070	Pumpendeckel		
6	61068	Ölschauglas		
7	19621	O-Ring 56,0 x3,55 NBR70		
8	19643	Rillenkugellager 6305	BALL BEARING	ROULEMENT A BILLES
9	61088	Kolben Set D15		
10	61065	Pumpengehäuse		
11	19620	O-Ring 15,0 x2,65 NBR70	O-RING	
12	6868	Verschuß-Schraube G3/8	Screw plug G3/8	Bouchon G3/8
13	62304	Kurbelwelle bei Silver *EU*		
	61067	Kurbelwelle bei Wap 2200 W, Wap 3300, Silver W*GB*		
	61066	Kurbelwelle bei Wap 2200		
14	61071	Paßfeder		
15	61069	Wellendichtring 25x 62x10		
16	61089	Abdeckplatte		
17	5274	Senkschraube M8X 16 963 ZN		
18	61087	Kolbenführung Set		
19	61090	O-Ring 101,27x2,62		
20	61091	Pumpendeckel		
21	61117	Entlüftungsventil		
22	13770	O-Ring 12,0 x1,5	O-Ring 12x1,5	Joint torique 12x1,5
23		Zyl. Schraube M 6x 16	Socket head cap screw M6x16	Vis cylindrique M6x16 DIN 91

2200
2200W
3300
Silver
Silver W

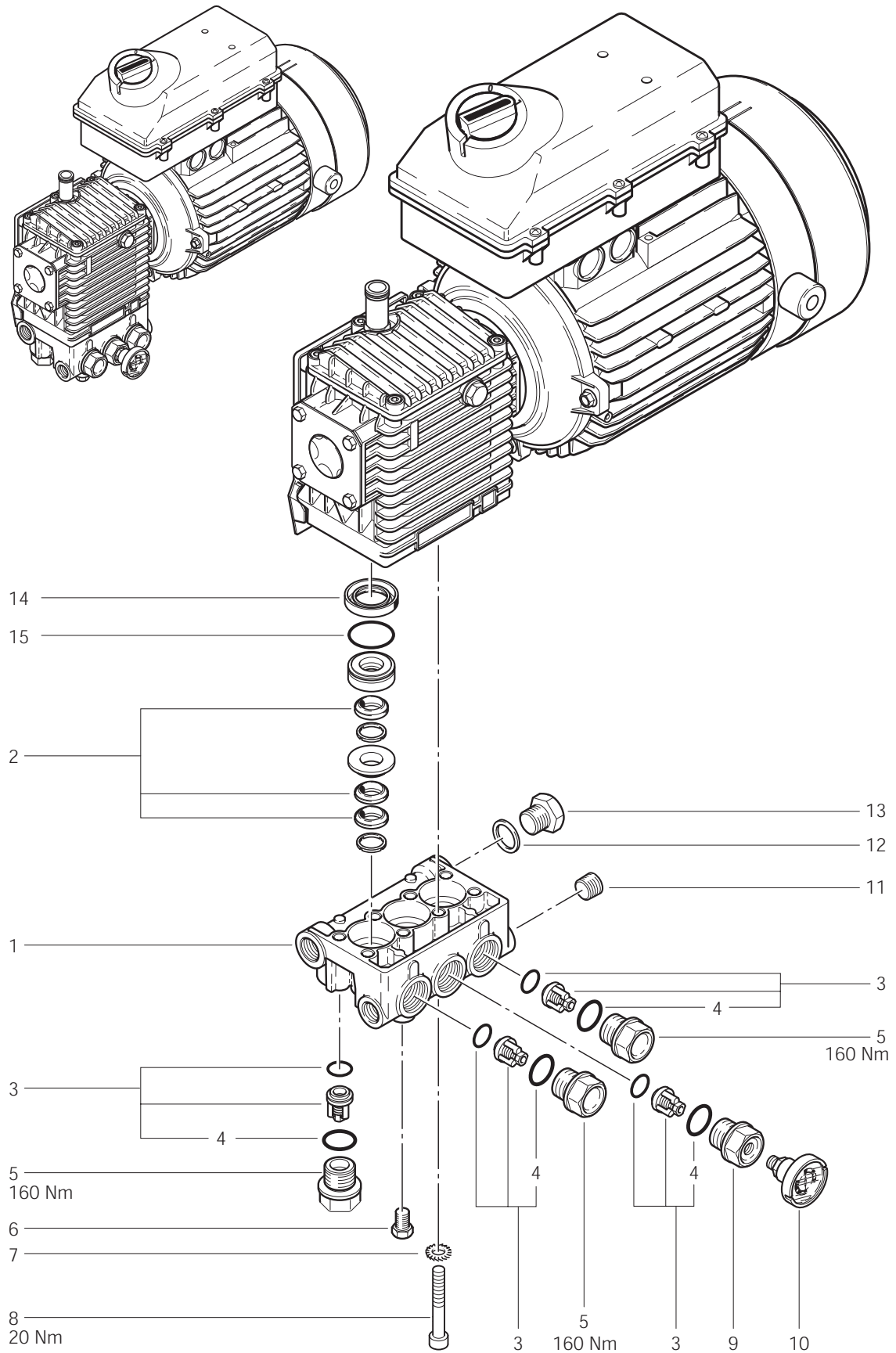

POS.	NO.	BEZEICHNUNG	DESCRIPTION	DESIGNATION
1	61074	Ventilblock		
2	61079	Dichtungssatz f.Kolben für 3 Kolben		
3	61077	Ventil Set für 6 Ventile		
4	29582	O-Ring 20,24x2,62	O-Ring 20,24x2,62	Joint torique 20,24x2,62
5	61078	Verschußschraube M24x1,5		
6	33047	Schraube Verschuß- G1/8" Ms	SCREW PLUG	
7		Zahnscheibe A 8,2	Serrated lock washer A8,2 DI	Rondelle evantail A8,2 DIN 67
8		Zyl. Schraube M 8x 60	Socket head cap screw M8x6	Vis cylindrique M8x60 DIN 91
9	61076	Verschußschraube M24x1,5		
10	61040	Manometer		
11	40979	Schraube Verschuß- G1/2"	PLUG	BOUCHON G 1/2"
12	1657	Dichtring 17 x 21 x 1,5 CU	Packing ring 17x21x1,5	Anneau d'isolation 17x21x1,5
13	6868	Verschuß-Schraube G3/8	Screw plug G3/8	Bouchon G3/8
14	40955	Wellendichtring 20x 30x 7	COLLAR	JOINT 20X30X7
15	40907	O-Ring 31,5 x1,8	O-Ring 31,5x1,8	Joint torique 31,5x1,8

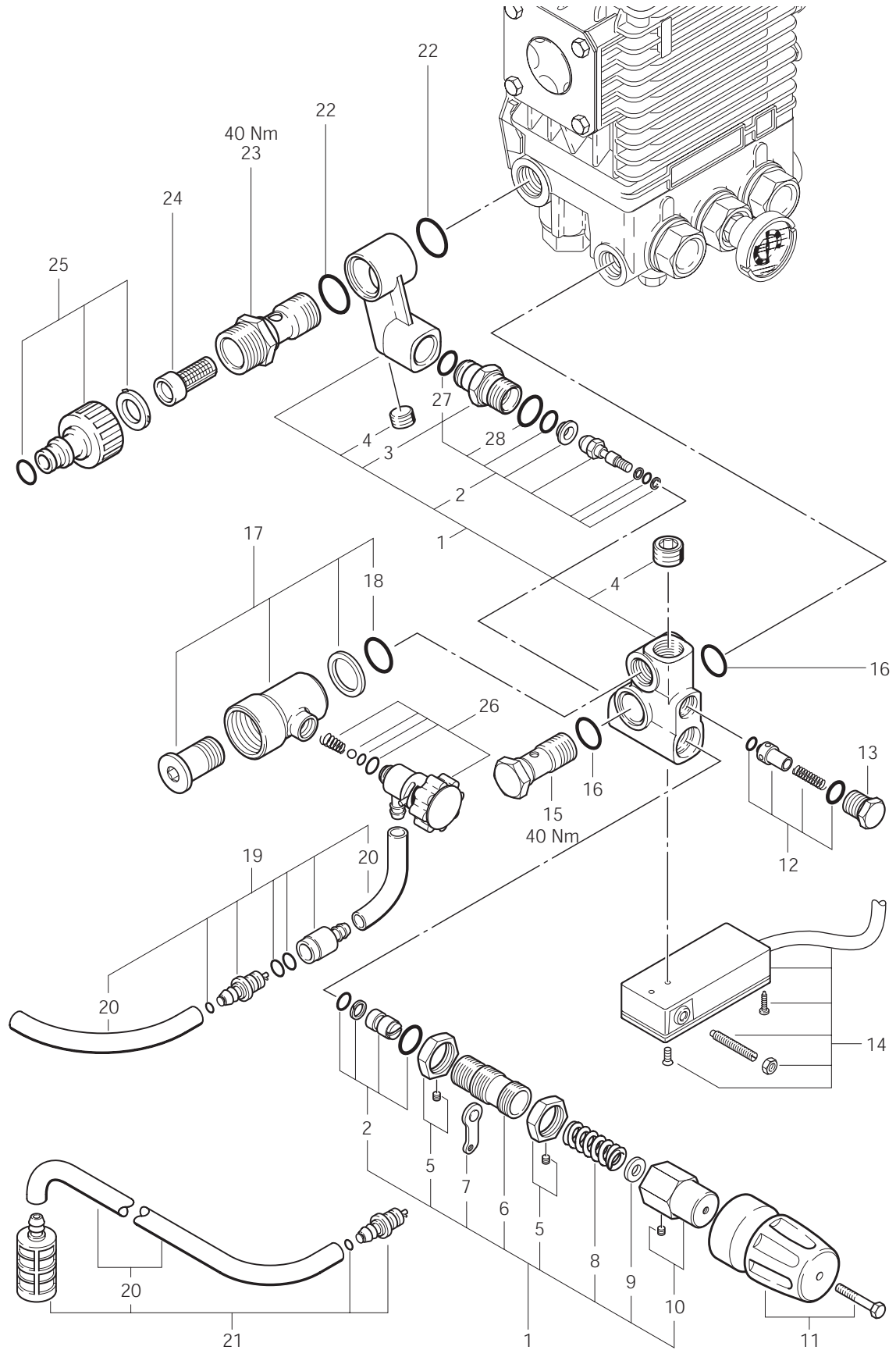

POS.	NO.	BEZEICHNUNG	DESCRIPTION	DESIGNATION
1	61081	Bypass-Ventil		
2	61082	Rep.Satz Steuerkolben		
3	40985	Nippel M18x1,5	NIPPLE	
4	6262	Verschluß-Schraube ¼"	"Screw plug 1/4" " " "	"Bouchon 1/4" " " "
5	40973	Mutter M20x1 x 5 Ms	SREW	
6	61075	Nippel M20x1,5-M18x1,5		
7	61084	Hebel		
8	40972	Druckfeder	PRESSURE SPRING	RESSORT
9	40971	Scheibe 3 x1,5	PRESSURE DISK	RONDELLE
10	61072	Stellhülse M20x1,5		
11	61085	Drehknopf		
12	61083	Rückschlagkolben		
13	40991	Schraube Verschluß- G1/4" A2	INSERT	
14	61098	Druckabschaltung		
15	61096	Hohlschraube R3/8"x45		
16	19696	O-Ring 16,0 x2,65 NBR70	O-RING 15,88X2,62	ANNEAU DE JOINT 15,88X2,6
17	61092	HD-Anschluß SET M27x1,5		
18	16443	O-Ring 17,0 x2,0	O-Ring 17,0x2,0	Joint torique 17,0x2,0
19	61097	Rückschlagventil		
◇	20	4973 Schlauch DN 6 x3	Hose DN 6x3	Tuyau DN 6x3
21	61255	Saug-SET		
22	40980	O-Ring 20,63x2,62 NBR70	O-RING 20,63X2,62	JOINT TORIQUE 20,63X2,62
23	61093	Wasseranschluß Set		
24	40982	Sieb	STRAINER	PASSOIRE
25	32541	Schlauchanschluß	Hose connector	Raccord tuyau flexible
26	29929	Dosierventil	Metering valve	Soupape de dosage
27	9146	O-Ring 10,77x2,62 NBR70	O-RING 10,78X2,62	JOINT TORIQUE 10,78X2,62
28	47813	O-Ring 14,0 x2,65	O-Ring 14,0x2,65	Joint torique 14,0x2,65
◇	ACHTUNG! - Meterware - Bitte bei Bestellung gewünschte Länge angeben!			
◇	ATTENTION! - Lengths in metres - Please indicate required lenth when ordering!			
◇	ATTENTION! - Longueurs par mètre - Préciser la longueur à la commande!			

2200
2200W
3300
Silver
Silver W

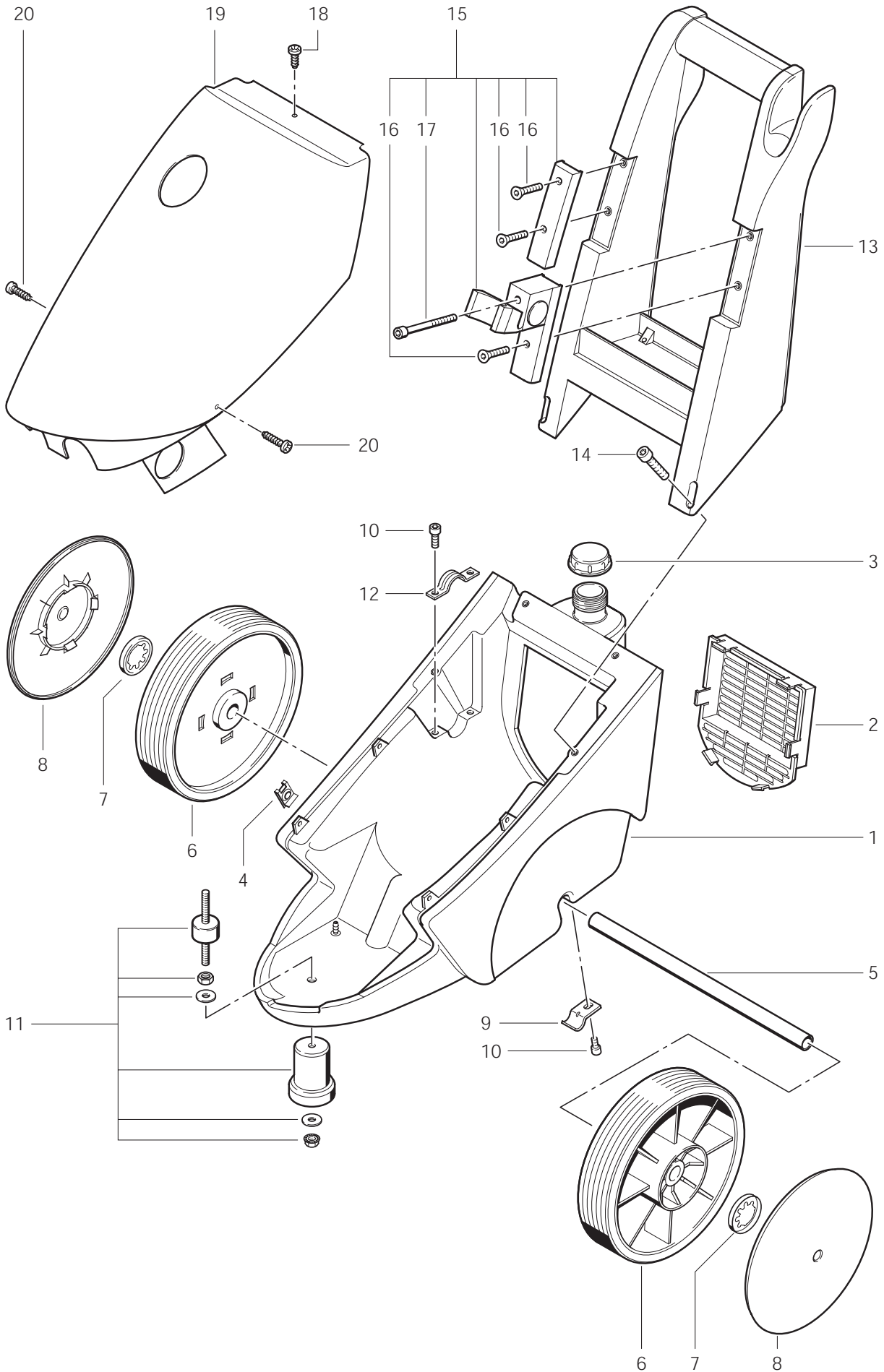

POS.	NO.	BEZEICHNUNG	DESCRIPTION	DESIGNATION
1	61100	Fahrwagen		
2	61086	Lüftungsgitter		
3	61102	Tankdeckel		
4	51463	Blechmutter BG 4,8		
5	61103	Achse		
6	61105	Rad		
7	7022	Klemmring	Clamping ring D20x3,3	Rondelle frein D20x3,3
8	61106	Radkappe		
9	61104	Haltebügel		
10		Zyl. Schraube M 6x 16	Socket head cap screw M6x1	Vis cylindrique M6x16 DIN 91
11	61119	Fuß		
12	61118	Bügel		
13	61101	Schubbügel		
14		Zyl. Schraube M 6x 25	Socket head cap screw M6x2	Vis cylindrique M6x25 DIN 91
15	61116	Ablage Set		
16	24311	Senkschraube M6x25	Countersunk screw M6x25	Vis à tête fraisée M6x25
17		Zyl. Schraube M 6x 65	CAP SCREW	VIS BTR M6 X 65
18	9781	Schraube BI- 3,5x 9,5	Sheet metal screw B3,5x9,5	Vis autotaraudeuse B3,5x9,5
19	61109	Haube		
20	9221	Schraube BI- 4,8x19	Sheet metal screw 4,8x19	Vis autotaraudeuse 4,8x19 D

2200
2200W
3300
Silver
Silver W

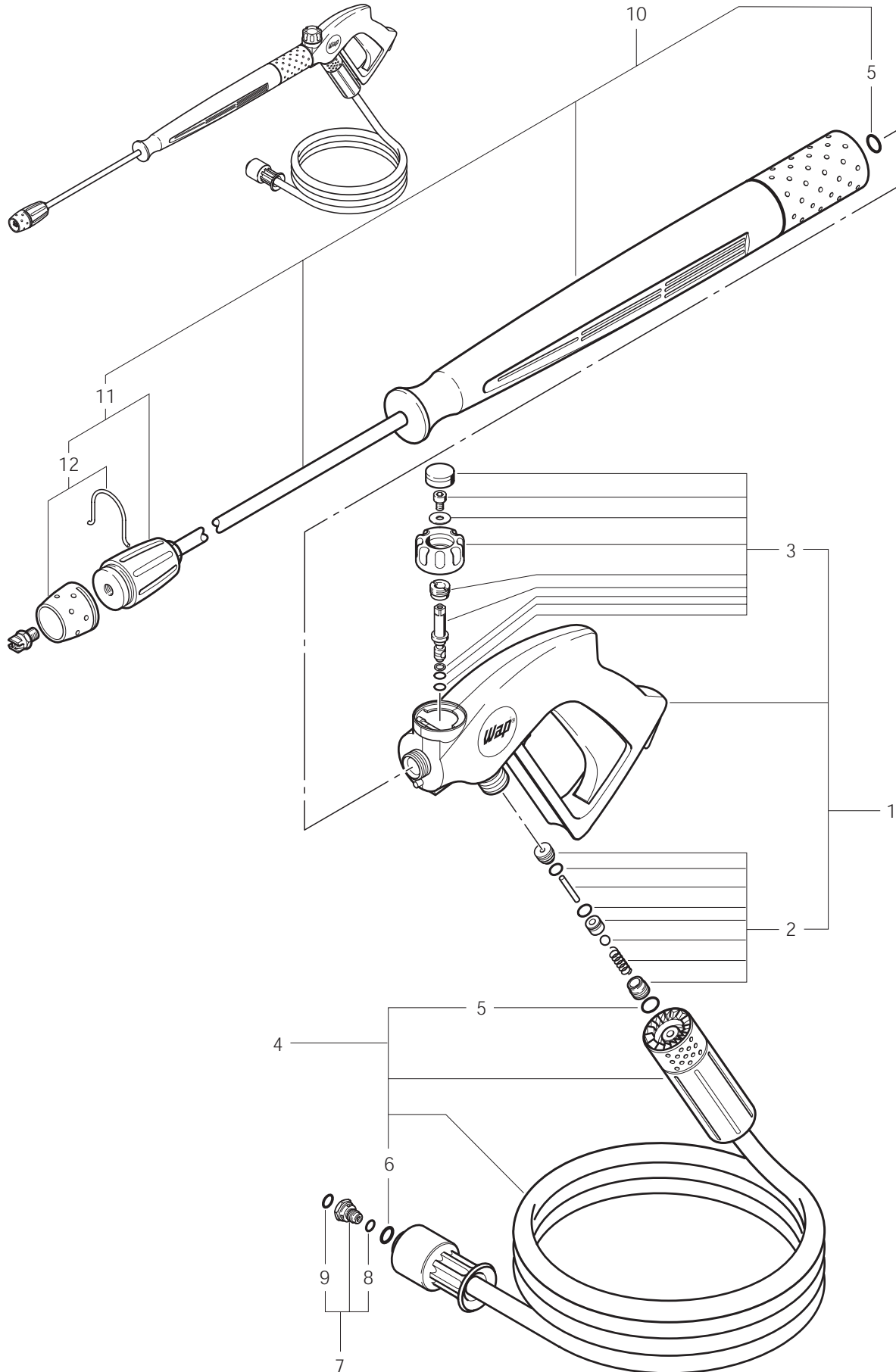

POS.	NO.	BEZEICHNUNG	DESCRIPTION	DESIGNATION
1	61035	Abschaltpistole bei Silver W*GB* ohne Abbildung		
	61111	Abschaltpistole		
2	61041	Dichtsatz für Pistole 61111 + 61035		
3	61113	Dichtsatz für Pistole 61111		
4	61115	HD-Schlauch DN 8x10m		
	62363	HD-Schlauch DN 8x15m bei Silver*EU*, Silver W*GB*		
5	6149	O-Ring 9,3 x2,4	O-Ring 9,3x2,4	Joint torique 9,3x2,4
6	49587	O-Ring 20,35x1,78 NBR90		
7	62154	Injektordüse bei Wap 2200 W, Silver W*GB*		
	62156	Injektordüse bei Wap 2200, Silver*EU*		
	62157	Injektordüse bei Wap 3300		
8	16925	O-Ring 8,0 x2,0	O-Ring 8,0x2,0	Joint torique 8,0x2,0
9	1381	O-Ring 14,0 x2,0	O-Ring 14,0x2,0	Joint torique 14,0x2,0
10	61039	Sprührohr 840 mm bei Silver W*GB*		
	61114	Sprührohr 950 mm		
11	61037	FlexoPowerJet-Düse		
12	61038	Düsenschutz		

2200
2200W
3300
Silver
Silver W

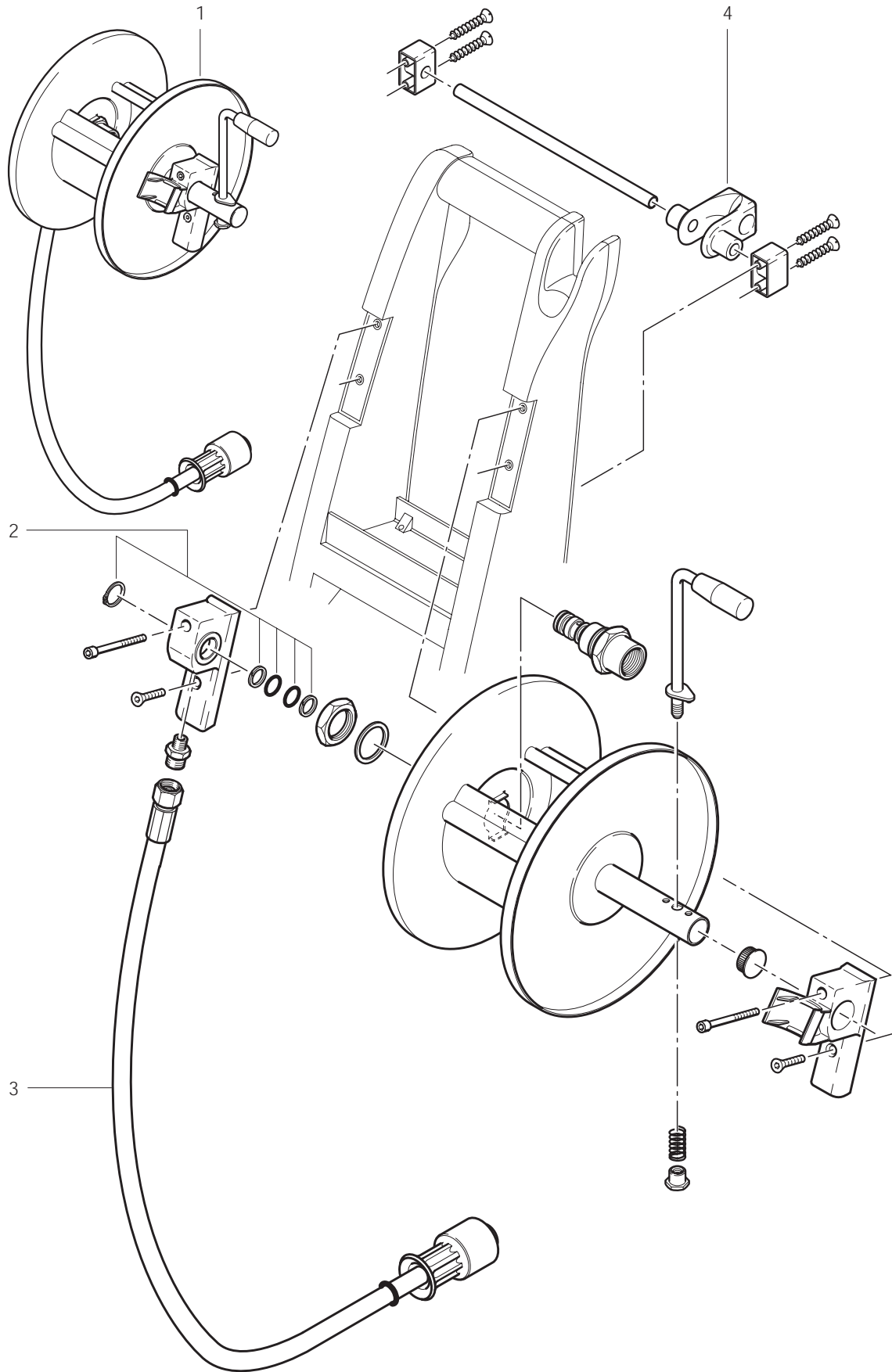

POS.	NO.	BEZEICHNUNG	DESCRIPTION	DESIGNATION
1	61253	Schlauch-Trommel Wap 2200 / 3300		
2	62317	Dichtungssatz f.Schlauchtrommel		
3	62318	HD-Schlauch DN 8		
4	62454	Schlauchführung		

2200
2200W
3300
Silver
Silver W