

Typ 578-603 2160XP Diesel 44 HP Perkins Vermerke

Adjustable Foot Pedal (3/95)
Back Up Alarm Option (3/95)
Brake Light Option (3/95)
Brake Pedal (3/95)
Broom Chamber Flaps (3/95)
Broom Chamber Flaps (7/95)
Broom Chamber Seals (3/95)
Broom Chamber Seals (7/95)
Broom Door (3/95)
Broom Options (3/95)
Cab Dome Light Option P/N 0880-616 (7/95)
Cab Door (7/95)
Cab Electrical Assembly (7/95)
Cab Fan Option P/N 0880-615 (7/95)
Cab Heater Option P/N 0880-603 (7/95)
Cab Option (7/95)
Cab Windshield Wiper Option P/N 0880-614 (7/95)
Control & Relief Valve - Exploded View (7/95)
Control Valve (11/95)
Control Valve (3/95)
Decals (3/95)
Diesel Engine (3/95)
Diesel Fuel System (3/95)
Dump Door (11/95)
Dump Door (3/95)
Dump Door (7/95)
Electrical Assembly - Battery (3/95)
Electrical Assembly Relays (3/95)
Electrical Harness Routing - Diesel Machines (3/95)
Electrical Harness Routing - Gas/LP Machines (3/95)
Electronic CDC (11/95)
Electronic CDC Electrical Assembly (11/95)
Electronic CDC Option (11/95)
Engine Cover (3/95)
Filter Shaker - Exploded View (7/95)
Filter Shaker (3/95)
Fire Extinguisher Option (11/95)
Fire Extinguisher Option (3/95)
Flaps (Wheel Well) (3/95)
Floor Assembly (3/95)
Forward Control (3/95)
Front Bumper (3/95)
Front Bumper (7/95)
Front Solid Cushion Tire Option (3/95)
Front Wheel (3/95)
Fuel Tank (3/95)
Fuel Tank (7/95)
Gasoline Engine (11/95)
Gasoline Engine (3/95)
Heavy Duty Air Cleaner Option (3/95)
Hopper (3/95)
Hopper Assembly (3/95)
Hopper Assembly (7/95)
Hopper Cover (11/95)
Hopper Cover (3/95)
Horn Electrical (3/95)
Hydraulic Filter (3/95)
Hydraulic Hose Diagram (3/95)
Instrument Housing (11/95)
Instrument Housing (3/95)
Instrument Housing (7/95)
Lights Electrical (3/95)
LP Engine (11/95)
LP Engine (3/95)
LP Ford 411 Engine Option (11/95)
LP Ford 411 Engine Option (3/95)
Main Broom Driver (3/95)
Main Broom Idler (3/95)
Main Broom Lever (3/95)
Main Broom Lift Frame (3/95)
Muffler - Exploded View (7/95)
Muffler (3/95)
Oil Cooler (3/95)
Overhead Guard Option (3/95)
Prototectoseal Gas Cap Option (3/95)
Pump (3/95)
Pump (7/95)
Purifier Muffler Option (3/95)
Radiator (3/95)

Rear Bumper (3/95)
Rear Solid Cushion Tire Option (3/95)
Rear Wheel (3/95)
Rear Work Light Option (3/95)
Relief Valve (11/95)
Relief Valve (3/95)
Reservoir (3/95)
Reverse Control (3/95)
Safety Arm (3/95)
Seat Assembly (3/95)
Shroud (3/95)
Side Broom Assembly (3/95)
Side Broom Lever (3/95)
Side Broom Lift System (11/95)
Side Broom Lift System (3/95)
Side Broom Spotlight Option (3/95)
Skirted Vacuumized Side Broom (11/95)
Spare Parts Kit (3/95)
Spare Parts Kits - Diesel Machines (11/95)
Spark Arrestor Option (3/95)
Steering Column (11/95)
Steering Column (3/95)
Strobe Light With Overhead Guard Option (11/95)
Strobe Light With Overhead Guard Option (3/95)
Strobe Light Without Overhead Guard Option (3/95)
Suspension Seat Option (3/95)
Tie Down Option (3/95)
Total Steel Package (11/95)
Turn Signal Option (3/95)
Vac Fan (3/95)

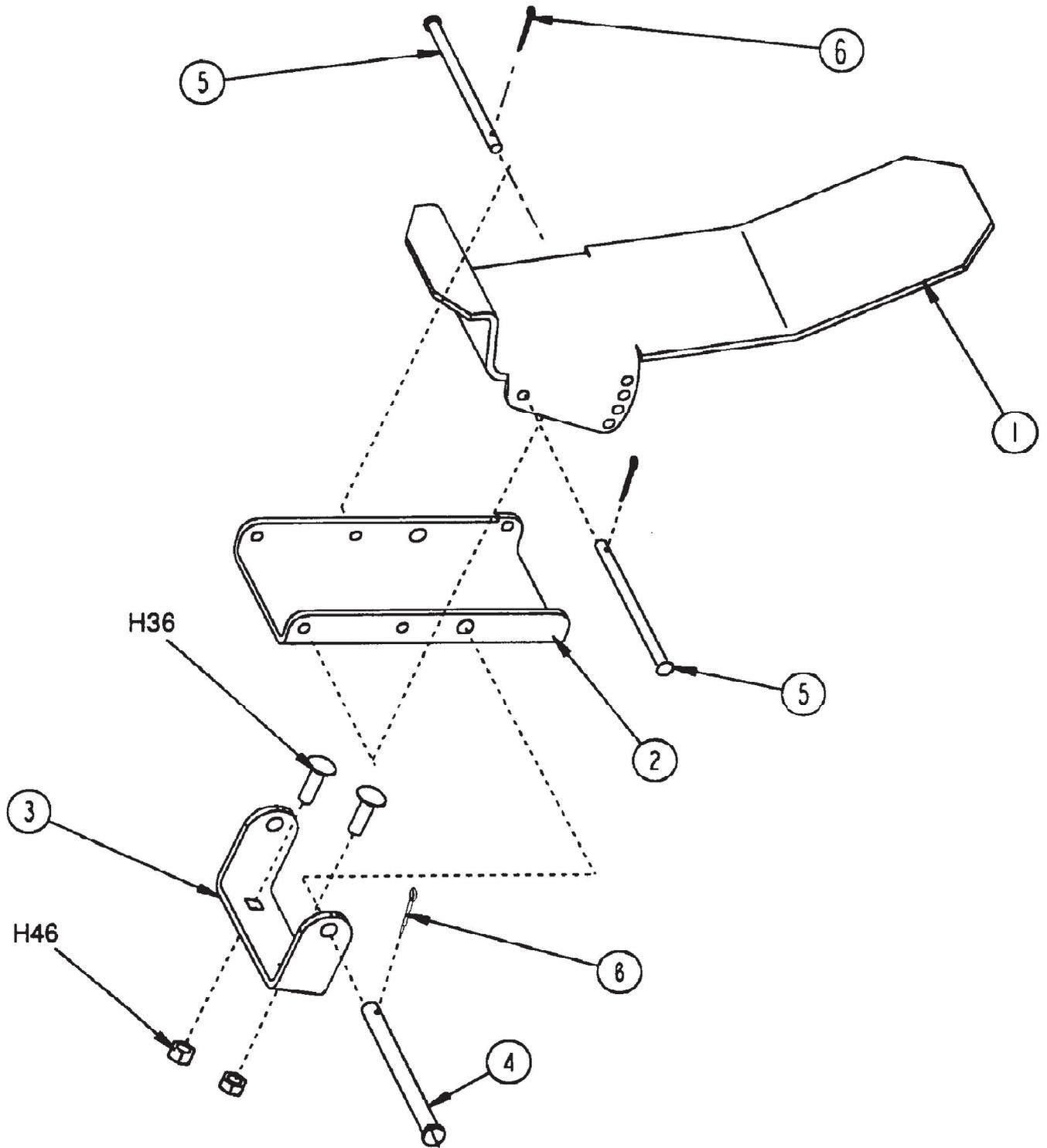

Referenznummer	Artikelnummer	Menge	Description
1	8-55-00034	1	Adjustable Foot Pedal
2	8-55-00035	1	Pedal Base
3	8-08-00782	1	Bracket
4	2-00-05246	1	Pin
5	2-00-05247	2	Pin
6	2-00-05249	3	Cotter Pin
H36	2-00-00196	2	Carriage Bolt, 5/16-18 x 1.000
H46	2-00-00644	2	Nut, 5/16-18, Insert Fiber

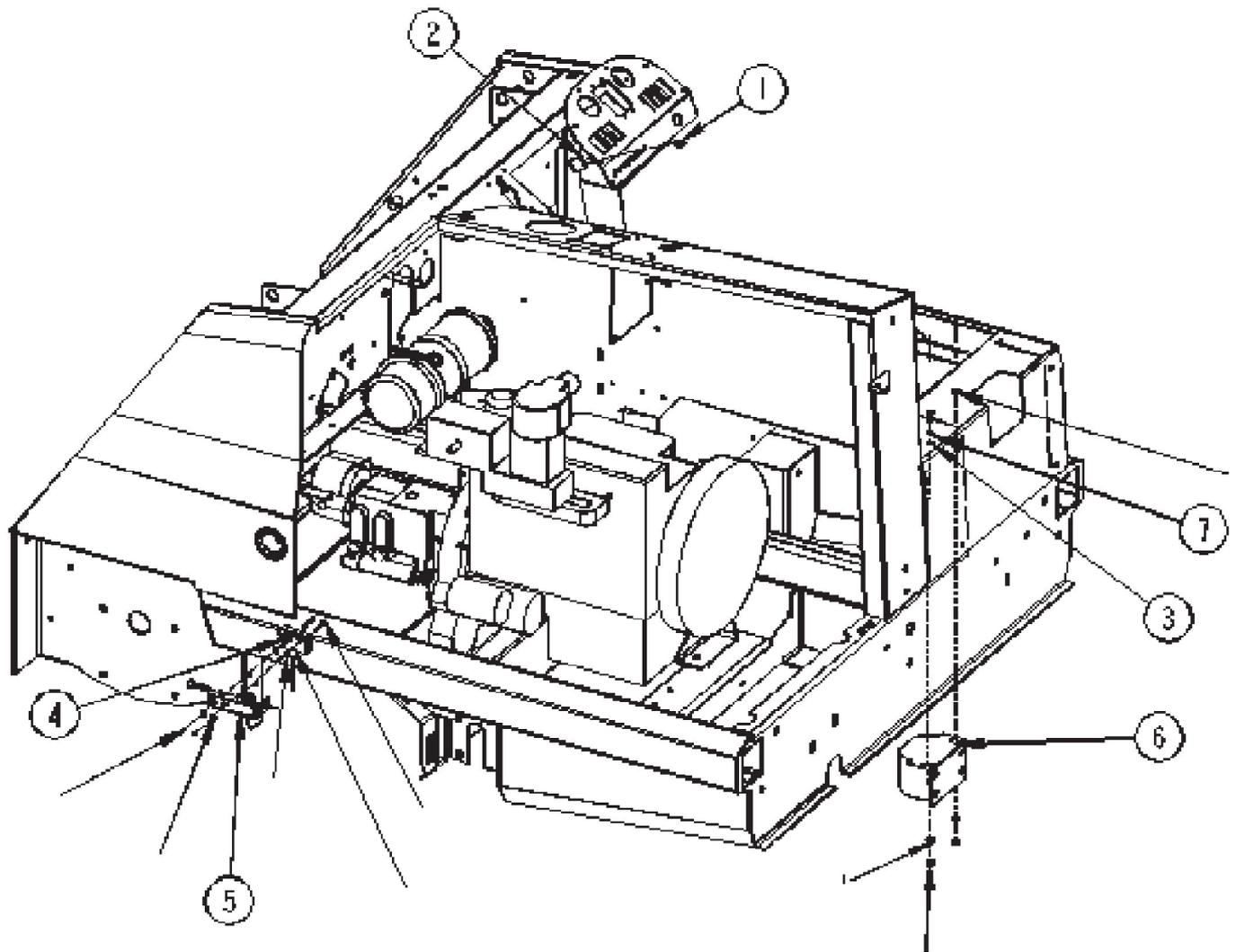
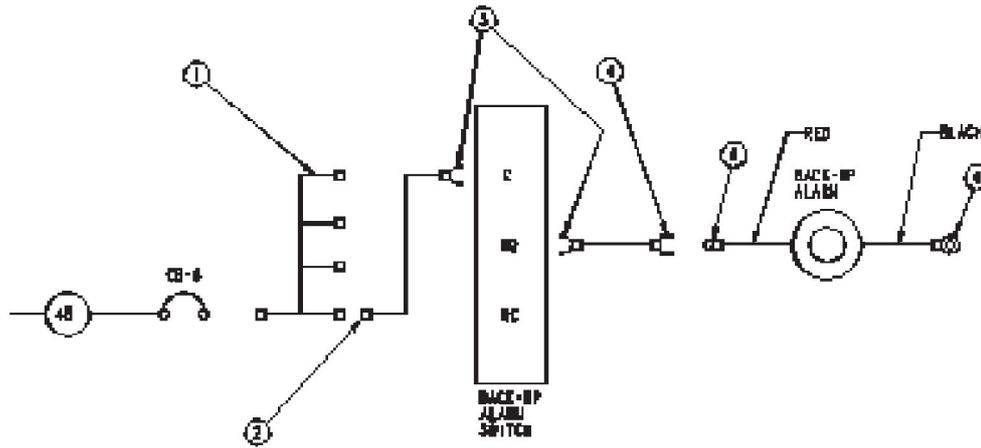

Referenznummer	Artikelnummer	Menge	Description
1	8-11-00044	1	Cap, Instrument Panel (Boot)
2	8-64-00008	1	Circuit Breaker, 15 amp
3	2-00-00501	1	Washer, Internal Lock
4	8-82-00058	1	Switch
5	8-08-02040	1	Bracket, Back Up Alarm Switch
6	8-32-09009	1	Alarm, Back Up
7	2-00-00828	Ref.	Ring Terminal
8	8-90-07434	1	Wing Wire
9	8-11-00015	1	Terminal
10	2-00-04742	2	Terminal
11	2-00-04626	1	Terminal
12	2-00-04578	1	Terminal, Male Bullet
13	2-00-00828	1	Ring Terminal

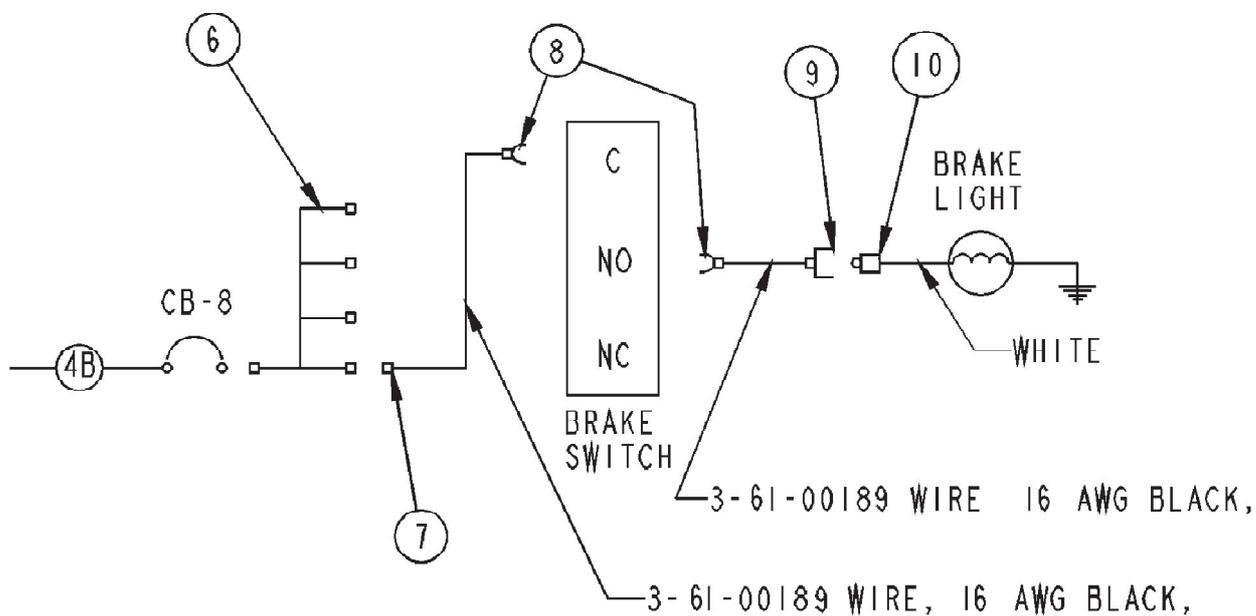
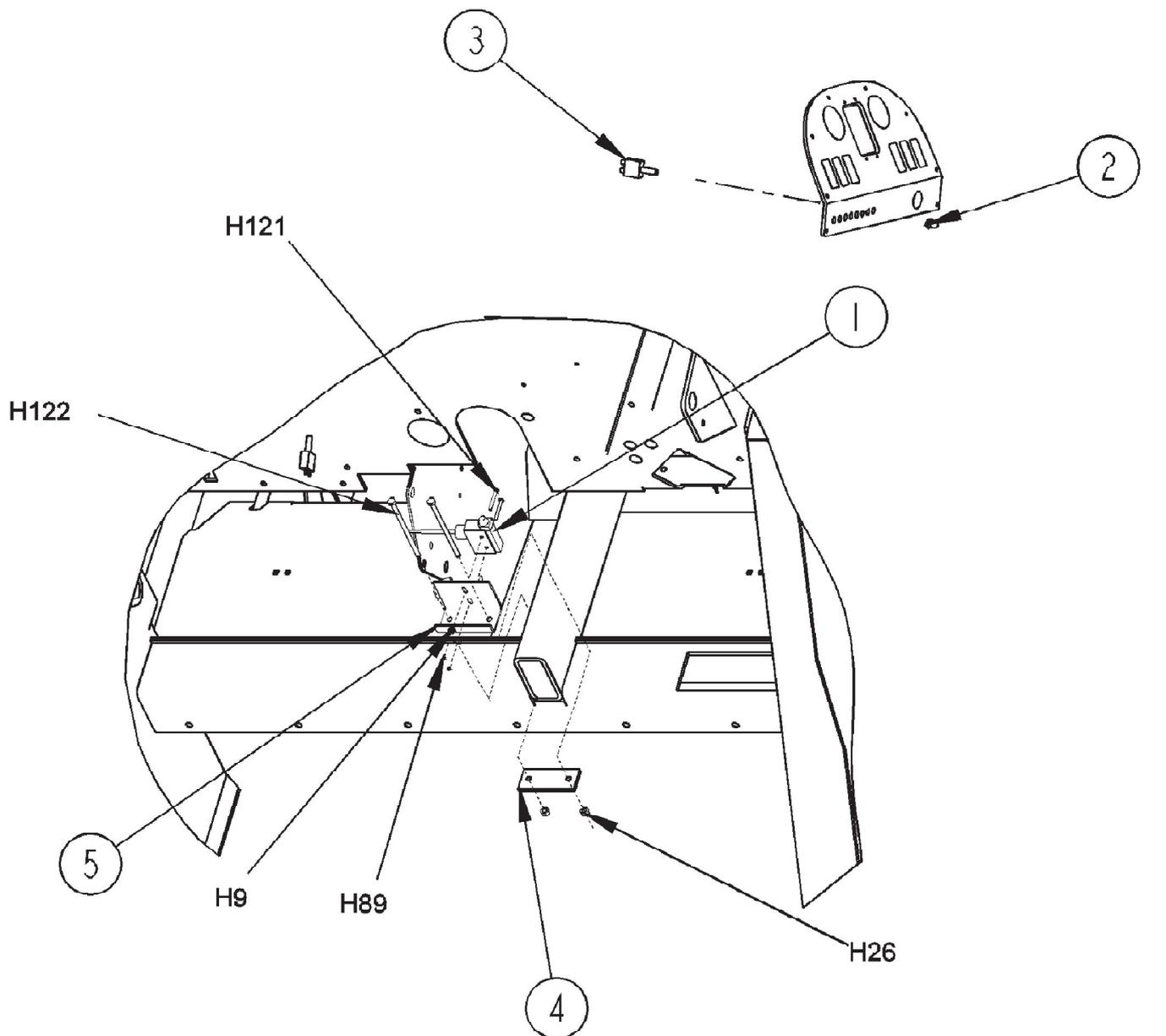

Referenznummer	Artikelnummer	Menge	Description
1	8-82-00058	1	Switch
2	8-11-00044	1	Cap, Instrument Panel Boot
3	8-64-00008	1	Circuit Breaker, 15 amp
4	8-13-07132	1	Clamp, Brake Switch
5	8-08-00818	1	Bracket, Brake Switch
6	8-90-07434	1	Wing Wire
7	8-11-00015	1	Terminal
8	2-00-04742	2	Terminal
9	2-00-04626	1	Terminal
10	2-00-04578	1	Terminal
	2-00-05291		Bulb, Brake Light (Service Part)
H9	2-00-00426	2	Flat Washer, .500 x .219 x .063
H26	2-00-00641	2	Nut, 1/4-20 Insert Fiber
H89	2-00-01372		Nut, Fiber Insert #8-32 Steel 2
H121	2-00-00090		Screw, #8-32 x 1.500 RHM 2
H122	2-00-05216	2	Screw, 1/4-20 x 5.000 HHC

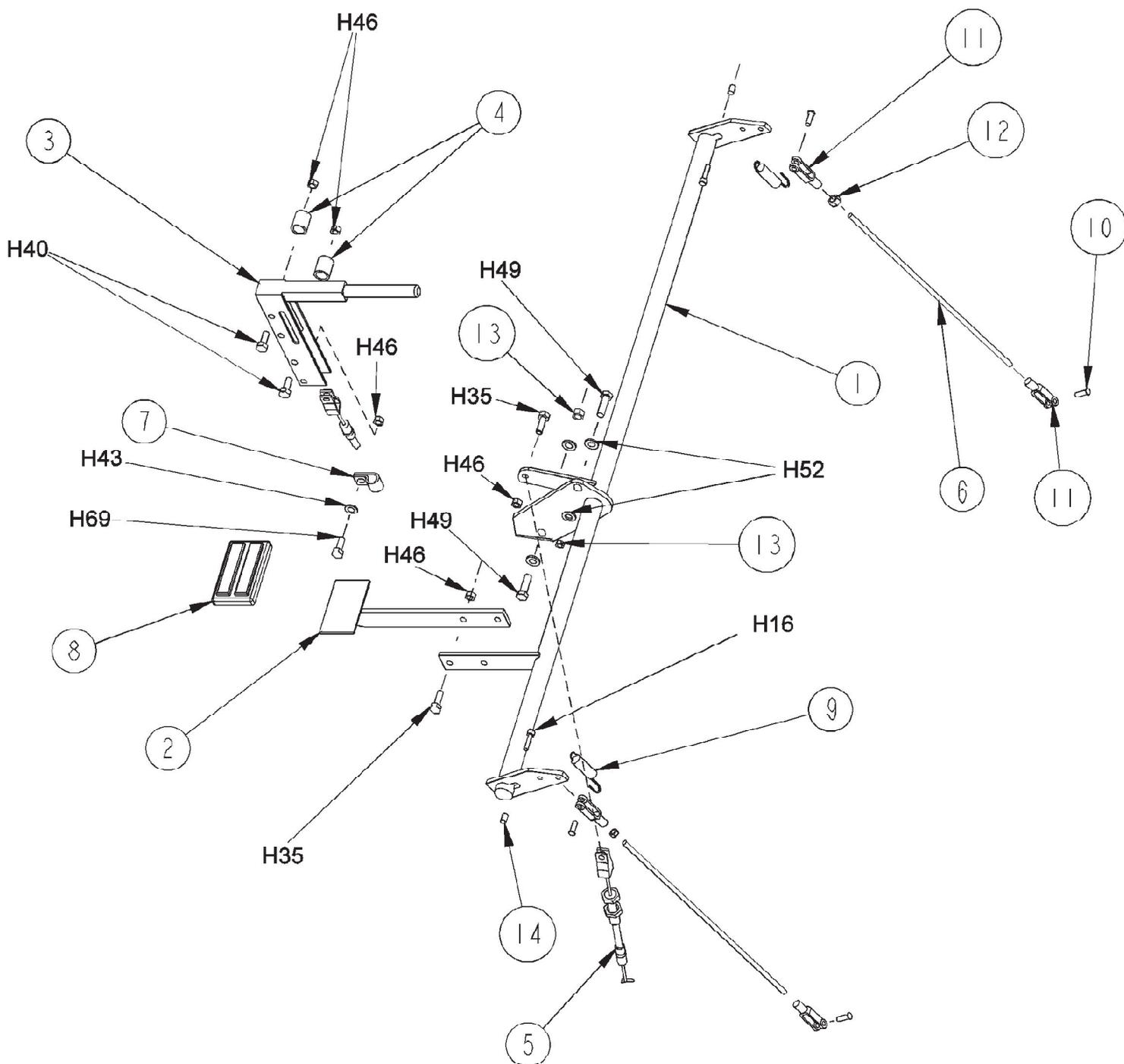

Referenznummer	Artikelnummer	Menge	Description
1	8-70-05293	1	Brake Cross Shaft
2	8-55-00033	1	Brake Pedal
3	7-41-05083	1	Lever, Parking Brake
4	8-75-01184	2	Spacer, Lever Mounting
5	8-10-00038	1	Cable
6	8-66-00154	2	Brake Rod
7	2-00-05169	1	Cable Clamp
8	7-50-05145	1	Pad, Pedal
9	7-76-00051	2	Spring
10	2-00-04909	4	Yoke Pin Assembly
11	8-14-01006	4	Clevis
12	2-95-01999	4	Nut, Jam
13	2-00-04182	3	Nut, Jam
14	2-00-05261	2	Threaded Insert
H16	2-00-03051	2	Screw, 1/4-20 x .750 HSHC
H35	2-00-02708	3	Screw, 5/16-18 x 1.000 HHM
H40	2-00-01770	2	Screw, 5/16-18 x 2.750 HHC
H43	2-00-00409	1	Flat Washer, .687 x .344 x .062
H46	2-00-00644	6	Nut, 5/16-18, Insert Fiber
H49	2-00-00209	3	Screw, 3/8-16 x 1.250 HHC
H52	2-00-00402	6	Flat Washer, .750 x .390 x .094
H69	2-00-01255	1	Screw, 5/16-18 x .875 HHC

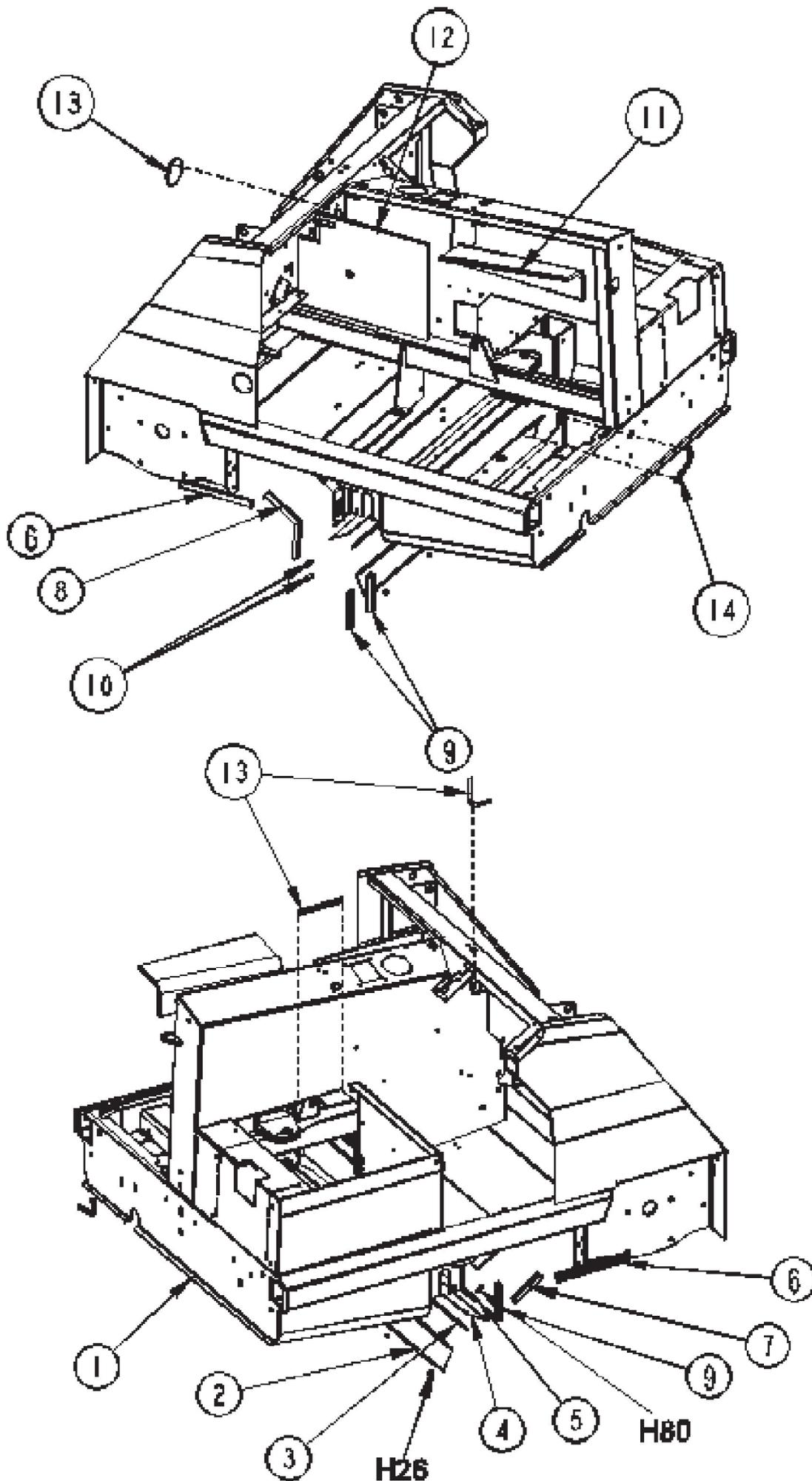

Referenznummer	Artikelnummer	Menge	Description
1	8-27-07111	1	Frame, Weldment
2	8-25-08197	1	Flap, Rear Inside Frame
3	8-13-07114	1	Clamp, Rear Flap Broom Chamber (Inner)
4	8-25-08196	1	Flap, Rear Outside Frame
5	8-13-07115	1	Clamp, Rear Flap Broom Chamber (Outer)
6	8-29-00231	2	Gasket
7	8-29-00232	1	Gasket
8	8-29-00234	1	Gasket
9	8-29-00233	3	Gasket
10	8-21-04048	2	Edging
11	8-34-09017	1	Insulation
12	8-34-09018	1	Insulation
13	7-21-04022	3	Edging
14	7-21-04031	1	Edging
H26	2-00-00641	5	Nut, 1/4-20 Insert Fiber
H80	2-00-02196	5	Carriage Bolt, 1/4-20 x 1.000 RHM

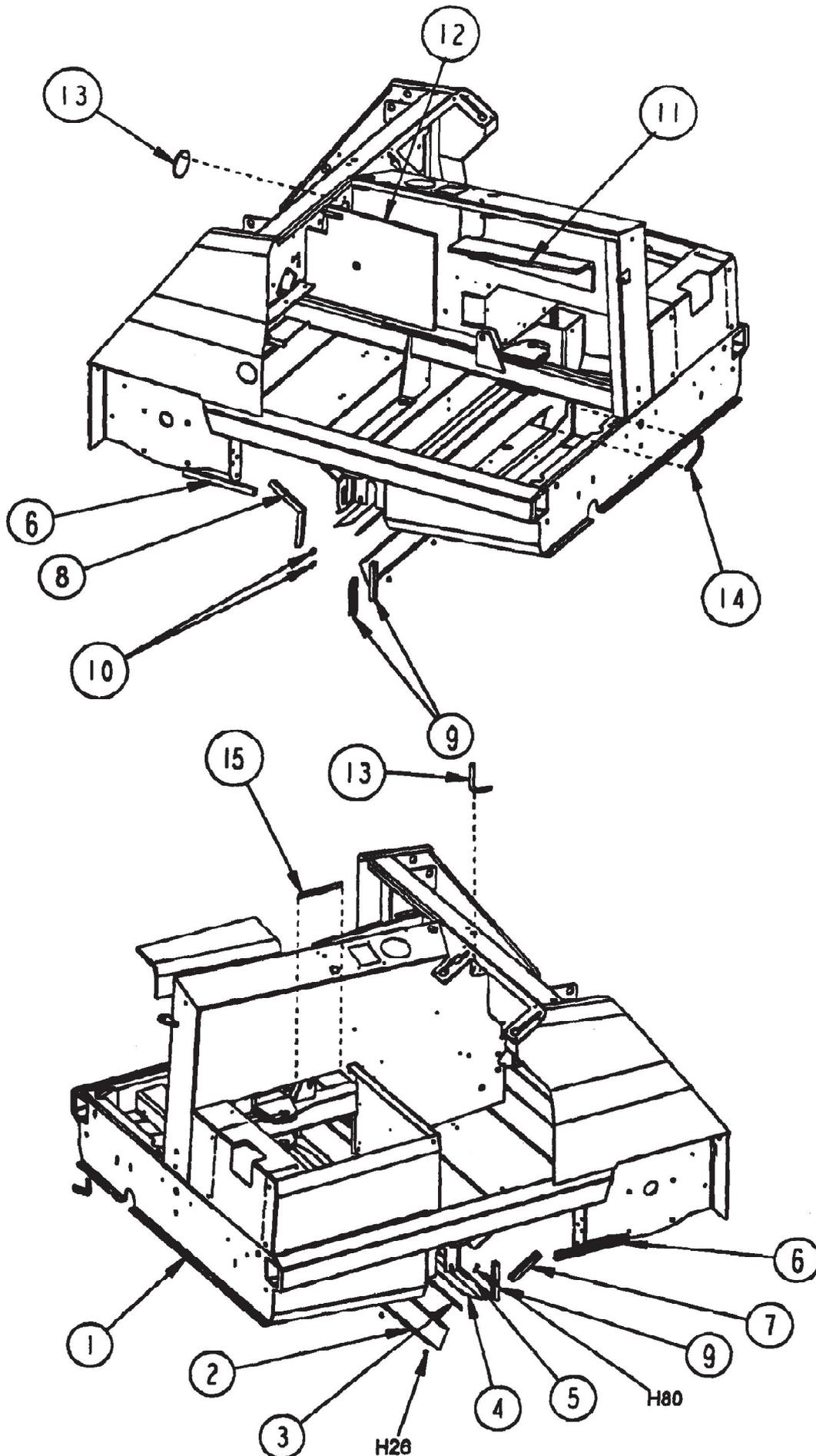

Referenznummer	Artikelnummer	Menge	Description
1	8-27-07111	1	Frame, Weldment
2	8-25-08197	1	Flap, Rear Inside Frame
3	8-13-07114	1	Clamp, Rear Flap Broom Chamber (Inner)
4	8-25-08196	1	Flap, Rear Outside Frame
5	8-13-07115	1	Clamp, Rear Flap Broom Chamber (Outer)
6	8-29-00231	2	Gasket
7	8-29-00232	1	Gasket
8	8-29-00234	1	Gasket
9	8-29-00233	3	Gasket
10	8-21-04048	2	Edging
11	8-34-09017	1	Insulation
12	8-34-09018	1	Insulation
13	7-21-04022	3	Edging
14	7-21-04031	1	Edging
15	7-21-03003	1	Edging
H26	2-00-00641	5	Nut, 1/4-20 Insert Fiber
H80	2-00-02196	5	Carriage Bolt, 1/4-20 x 1.000 RHM

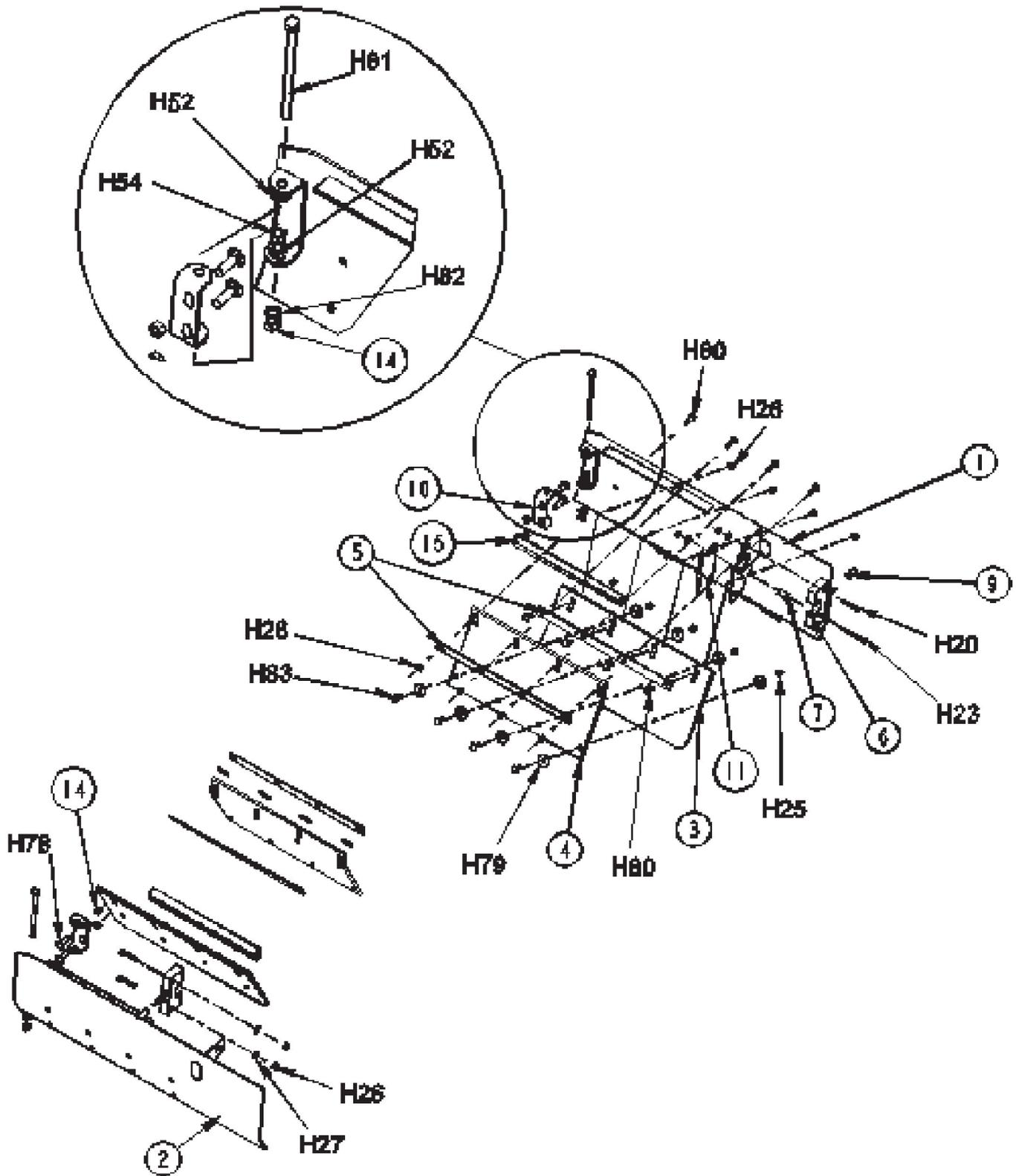

Referenznummer	Artikelnummer	Menge	Description
1	8-19-08060	1	Broom Door Weldment (Right)
2	8-19-08059	1	Broom Door Weldment (Left)
3	8-25-08195	2	Flap, Broom Door (Outer)
4	8-25-08198	2	Flap, Broom Door (Inner)
5	8-13-07116	4	Clamp, Broom Door Flap
6	8-41-00052	2	Latch
7	8-75-01199	1	Spacer, Broom Door Latch
8			UNKNOWN
9	8-39-00015	2	Latch Knob, Broom Door
10	8-57-05024	2	Door Pivot Bracket
11	8-58-05271	1	Plate, Idler Retainer
12			UNKNOWN
13			UNKNOWN
14	2-95-04182	6	Nut, Fiber
15	8-29-00235	2	Edging
H20	2-00-00203	4	Screw, 1/4-20 x 1.500 HHC
H23	2-00-01980	1	Screw, 1/4-20 x 2.500 HHC
H25	2-00-00594	8	Nut, Hex 1/4-20 x .437 x .218
H26	2-00-00641	21	Nut, 1/4-20 Insert Fiber
H27	2-00-03702	5	Washer, .625 x .281 x .063
H52	2-00-00402	4	Flat Washer, .750 x .390 x .094
H54	2-00-02360	2	Nut, 3/8-16 Hex.
H78	2-00-05187	4	Carriage Bolt, 3/8-16 x 1.250
H79	2-00-01676	16	Flat Washer, 1.062 x .265 x .062
H80	2-00-02196	16	Carriage Bolt, 1/4-20 x 1.000 RHM
H81	2-00-05276	2	Screw, 3/8-16 x 5.500
H82	2-00-00505	2	Lock Washer, 3/8 Int. Tooth
H83	2-00-04877	8	Screw, 1/4-20 x 1.000 BHS

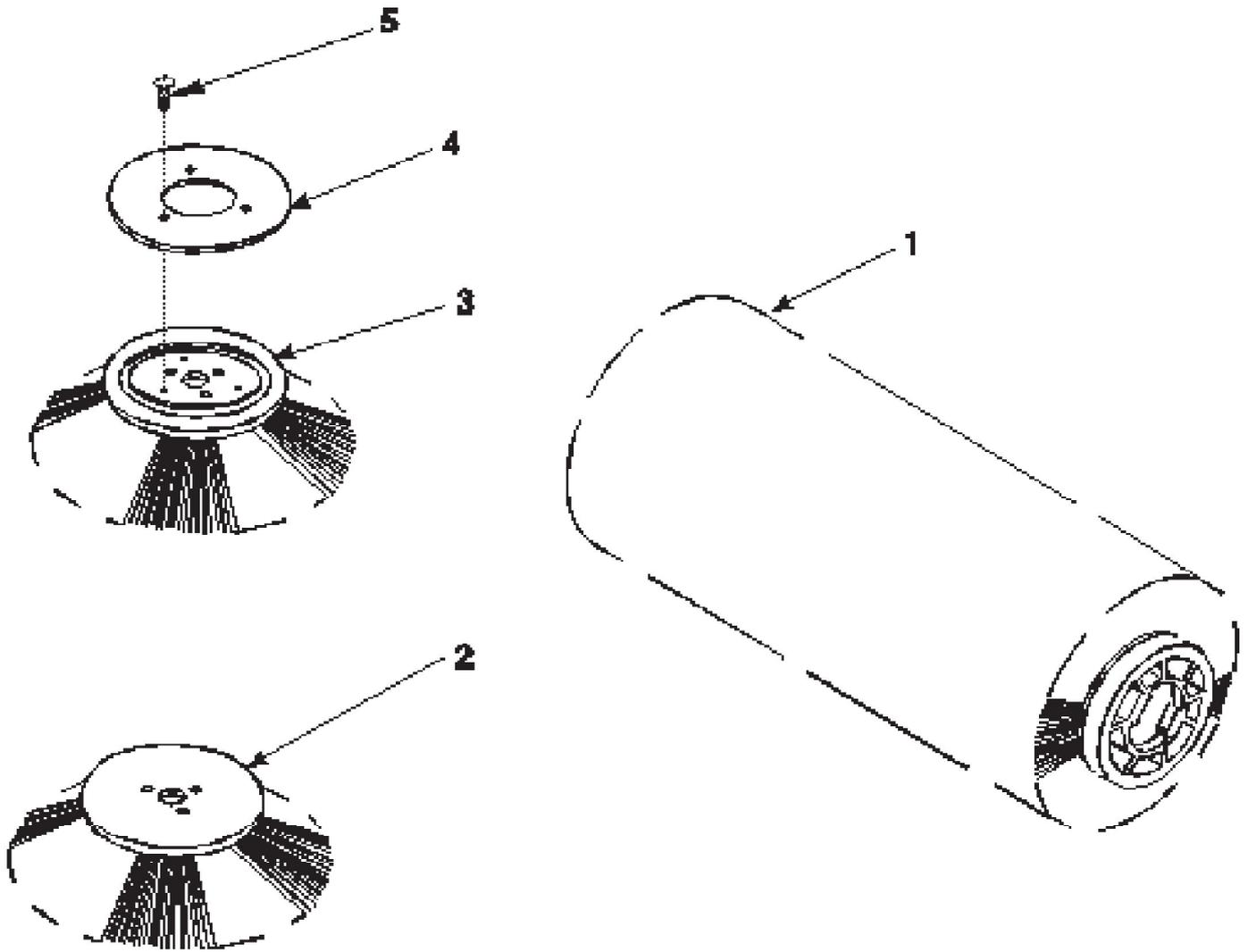

Referenznummer	Artikelnummer	Menge	Description
1	8-08-03217	Ref.	Proex and Wire Main Broom
1	8-08-03219	Ref.	Nylon Main Broom
1	8-08-03220	Ref.	Nylon, High Density Main Broom
1	8-08-03221	Ref.	Fiber and Wire High Density Main Broom
1	8-08-03218	Ref.	Poly and Wire Main Broom
2	8-08-03212	Ref.	Black Prolene Side Broom
2	8-08-03211	Ref.	Nylon Side Broom
	0880-439		Wire Bristle Side Broom Option
3	8-08-03199	1	Wire Side Broom 0880-439 Wire Bristle Side Broom Option
4	8-58-05248	1	Plate 0880-439 Wire Bristle Side Broom Option
5	2-00-04121	3	Screw #10-13 x .750 RHW 0880-439 Wire Bristle Side Broom Option

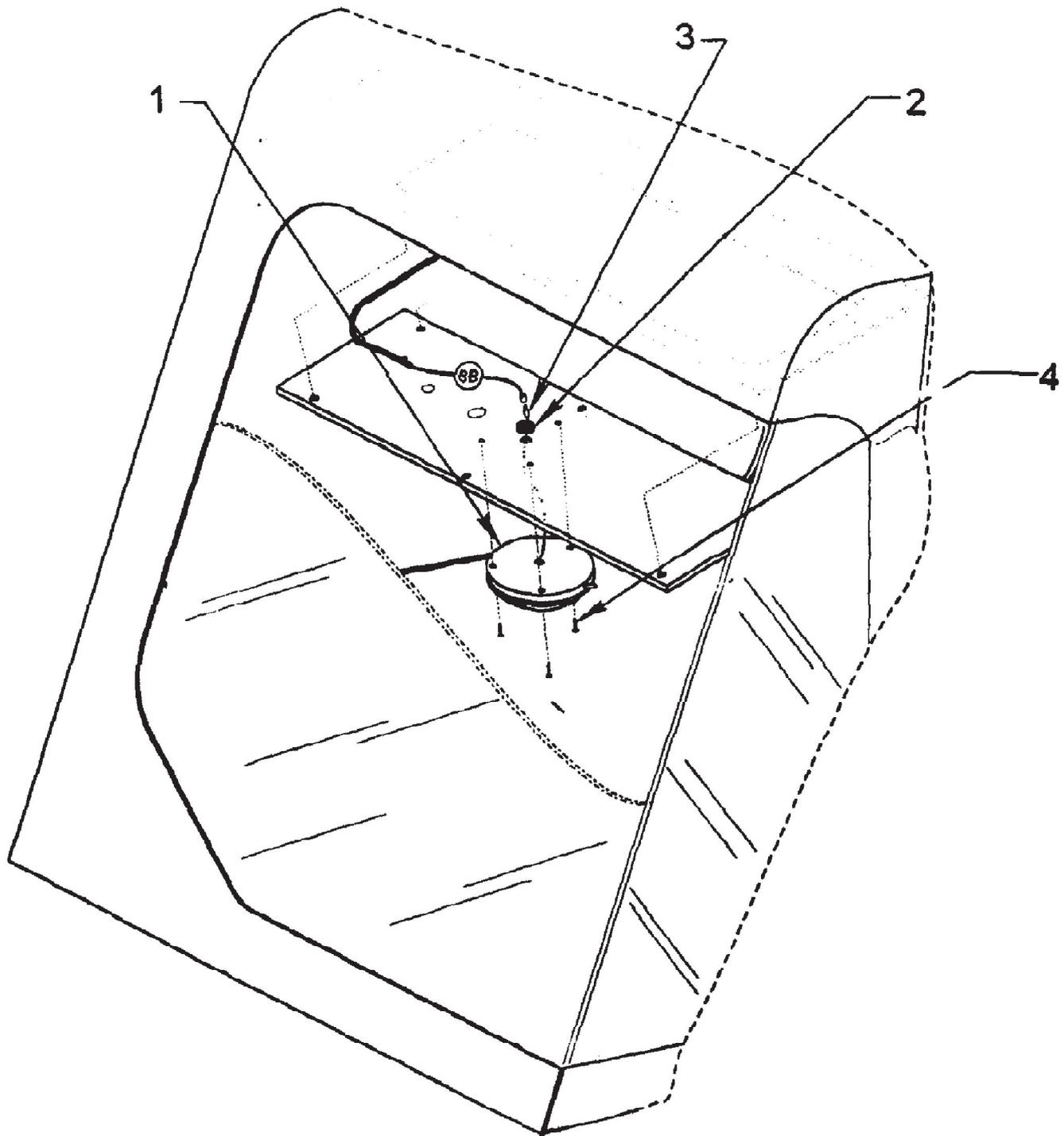

Referenznummer	Artikelnummer	Menge	Description
	0880-616		Cab Dome Light Option No.
1	8-40-05031	1	Dome Light
2	2-00-00491	1	Grommet
3	2-00-04578	1	Terminal, .156 Male Bullet
4	2-00-00044	3	Screw, #8-32 x .500 RHM

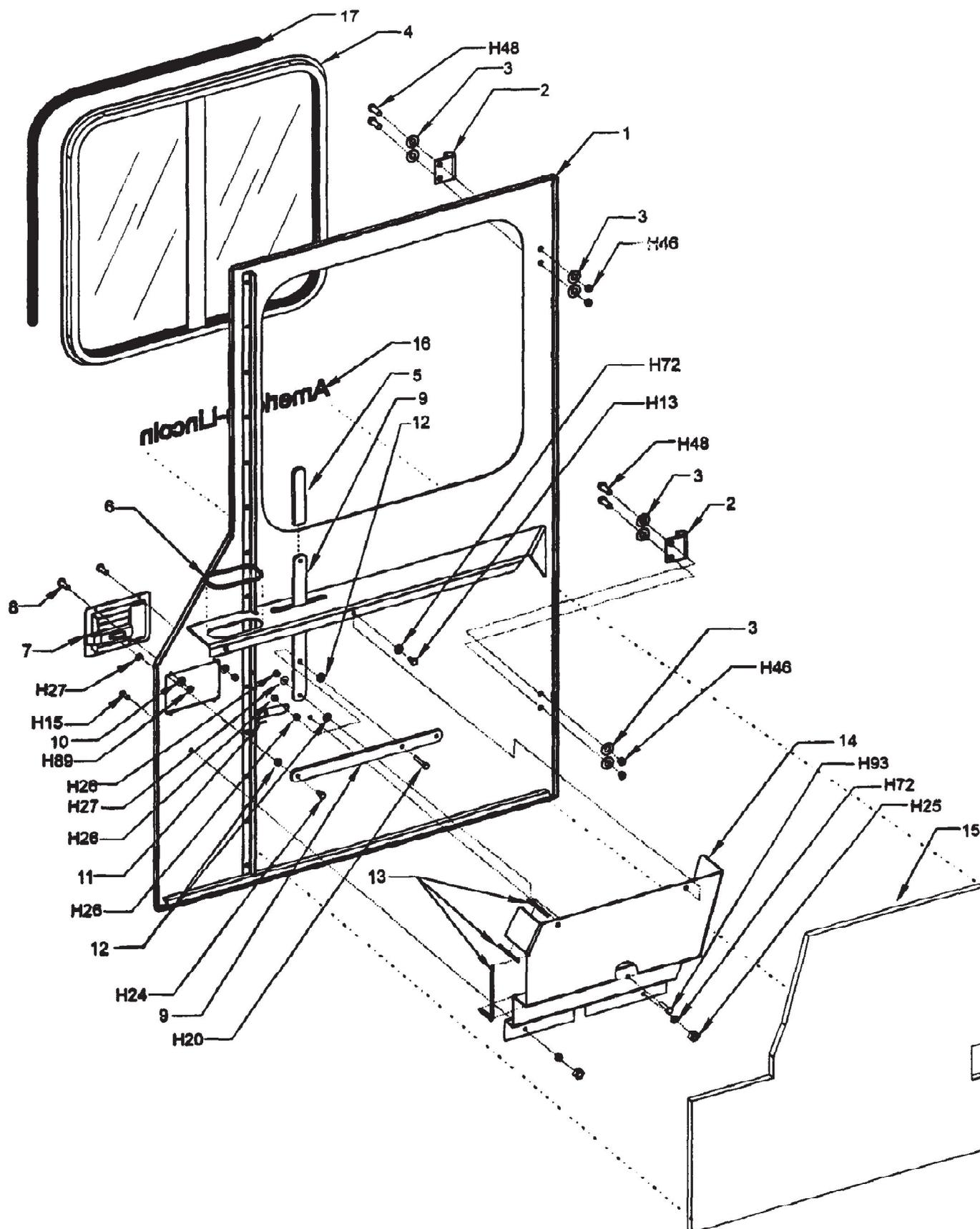

Referenznummer	Artikelnummer	Menge	Description
1	8-19-08065	1	Door
2	8-32-00048	2	Hinge
3	2-00-00419	8	Flat Washer .625 x .328 x .032
4	8-90-01002	1	Sliding Window
5	7-31-06066	1	Handle Grip 1.00 x .250
6	3-73-00054	1	Edging 1'
7	8-41-00062	1	Door Latch
8	2-00-00044	4	Screw #8-32 x.500 RHM
9	8-31-06089	2	Latch Handle
10	2-00-00460	4	Flat Washer, .437 x .192 x .031
11	7-76-00051	1	Spring
12	7-23-03048	3	Washer, Bevel
13	3-73-00024	1	Edging 1.5'
14	8-16-07368	1	Cover, Door Linkage
15	8-34-09027	1	Insulation, Cab Door
16	8-18-00400	1	Decal, A/L Logo
17	3-73-00082	1	Seal, Glass. 13 St'l x .19/.25 Glass 35'
H13	2-00-00054	8	Screw, 1/4-20 x .500 RHM HARDWARE
H15	2-00-00221	10	Screw, 1/4-20 x .750 HHC HARDWARE
H20	2-00-00203	1	Screw, 1/4-20 x 1.500 HHC HARDWARE
H24	2-00-00220	1	Screw, 1/4-20 x .625 HHC HARDWARE
H25	2-00-00594	7	Nut, Hex 1/4-20 x .437 x .218 HARDWARE
H26	2-00-00641	7	Nut, 1/4-20 Insert Fiber HARDWARE
H27	2-00-03702	4	Washer, .625 x .281 x .063 HARDWARE
H46	2-00-00644	4	Nut, 5/16-18, Insert Fiber HARDWARE
H48	2-00-00233	4	Screw, 3/8-16 x 1.000 HHC HARDWARE
H72			UNKNOWN
H89	2-00-01372	4	Nut, Fiber Insert #8-32 Steel HARDWARE
H93	2-00-00222	1	Screw, 1/4-20 x 1.250 HHM HARDWARE

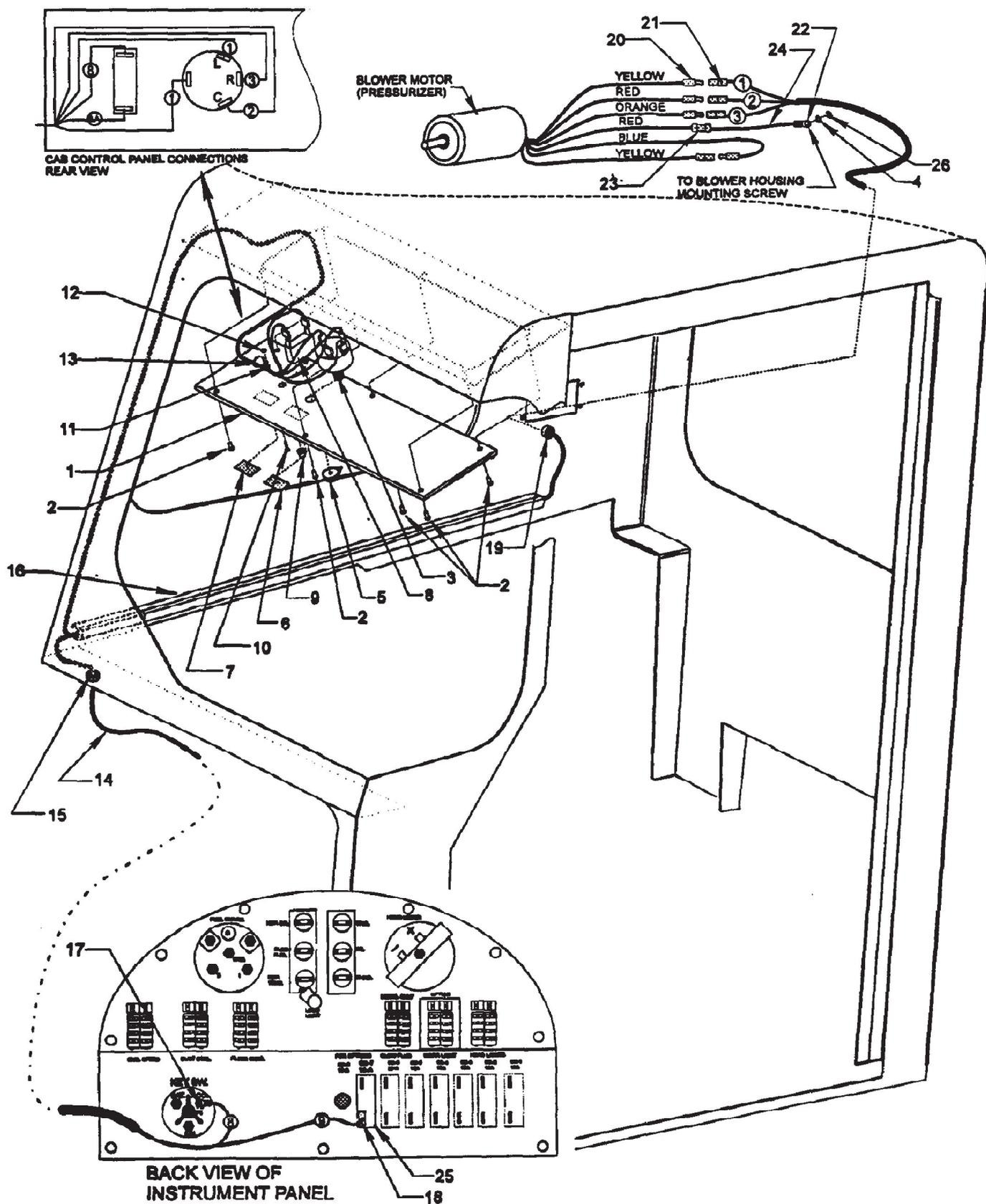

Referenznummer	Artikelnummer	Menge	Description
1	8-16-07364	1	Access Cover
2	2-00-00054	8	Screw, 1/4-20 x .500 RHM
3	7-82-00011	1	Switch, 4 Position Rotary w/Mtg. Nut
4	2-00-04670	1	Spring Washer
5	7-39-00019	1	Knob
6	8-18-00423	1	Decal, Pressurizer Fan
7	8-18-00422	1	Decal, CB-11
8	7-64-00022	1	Circuit Breaker, 20 Amp.
9	8-11-00044	1	Boot
10	2-00-00039	1	Screw, #10-24 x 1.000 RHM
11	2-00-00605	1	Nut, Hex MS #10-24 x .375 x .125
12	2-00-01246	1	Nut, Hex Fiber Insert, #10-24
13	2-00-04937	1	Wire Tie
14	0895-117	1	Cab Harness
15	2-00-01915	1	Grommet
16	8-20-06038	1	Wire Duct, 36"
17	2-00-04281	1	Terminal, #10 Stud, 14-16 ga. Insulated Ring
18	2-00-03418	1	Terminal, 1/4 Spade (Female Insulated)
19	2-00-00491	1	Grommet
20	2-00-04578	3	Terminal, Bullet (Male)
21	2-00-04626	3	Terminal, Bullet (Female)
22	2-00-00828	1	Terminal, 1/4 Non-Insulated Ring 14-16 ga.
23	2-00-01128	1	Terminal, Butt Connector
24	3-61-00193	1	16 ga., Red Insulated Wire
25	8-64-00008	1	Circuit Breaker, 15 amp.
26	2-00-00594	1	Nut, Hex 1/4-20 x .437 x .218

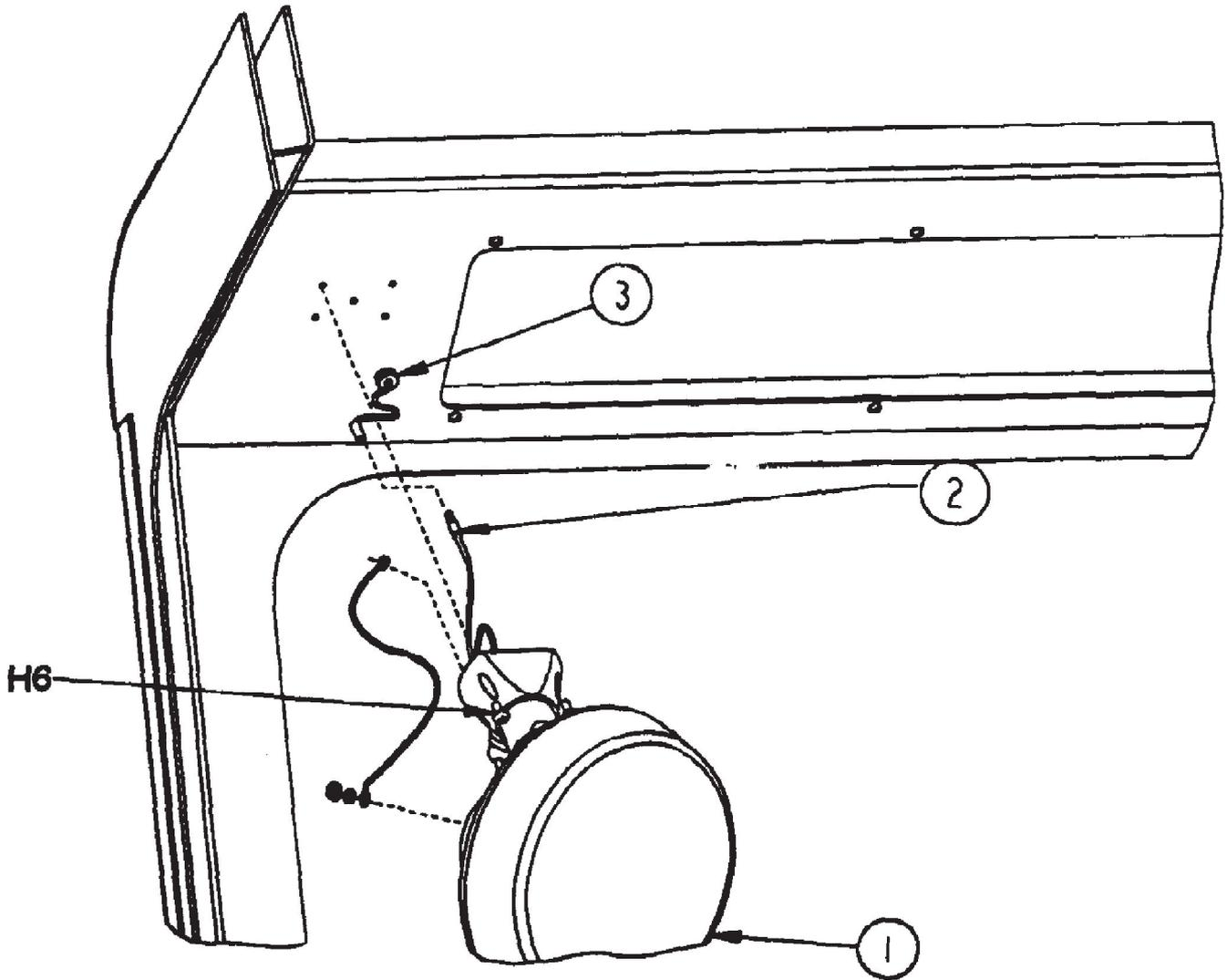

Referenznummer	Artikelnummer	Menge	Description
	0880-615		Cab Fan Option No.
1	8-23-00016	1	Defroster Fan
2	2-00-04578	1	Connector (Male Bullet)
3	2-00-04200	1	Grommet
H6	2-00-00049	4	Screw, #10-24 x .500 RHM HARDWARE

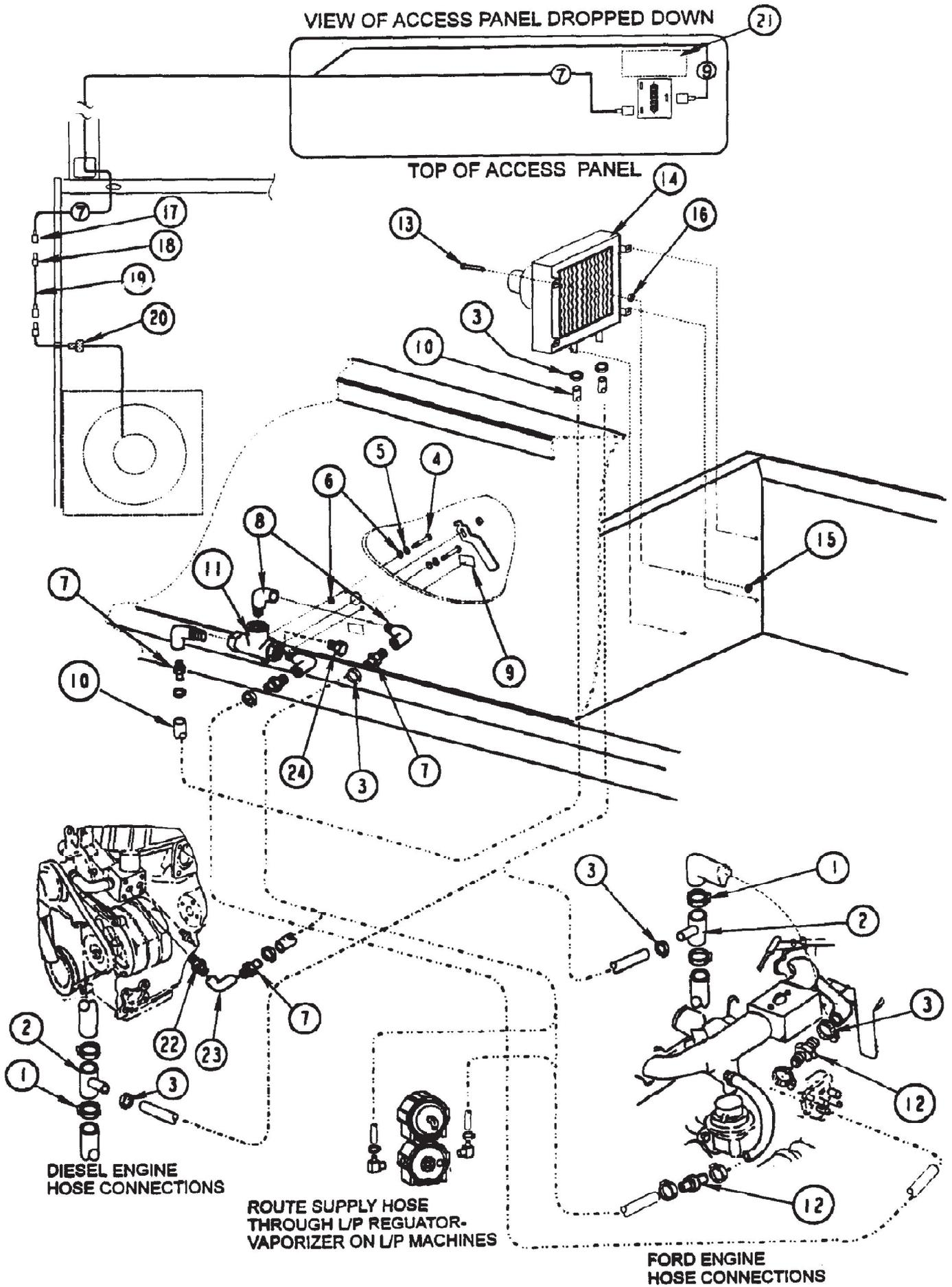

Referenznummer	Artikelnummer	Menge	Description
	0880-603		Cab Heater Option No.
1	2-00-03404	2	Hose Clamp
2	8-03-00055	1	Adapter Fitting
3	2-00-03407	10	Hose Clamp
4	2-00-03059	2	Screw, #10-24 x .38 RHM
5	2-00-00519	2	Lock Washer, #10 Med. H.S.
6	2-00-00726	4	Flat Washer, .500 x .219 x .063
7	7-25-02040	3	Fitting, 1/2 NPT x 5/8 Hose
8	2-00-04328	3	Street Elbow, 1/2 NPT
9	8-18-00331	1	Decal, Heater
10	3-71-00125	25	Hose, Heater 5/8 I.D.
11	8-88-00043	1	Valve
12	2-00-05318	2	Fitting, Union Barb 5/8 I.D. Hose
13	2-00-00056	4	Screw, #10-24 x .750 RHM
14	8-62-01013	1	Heater and Switch Kit
15	2-00-01246	4	Nut, Hex Fiber Insert #10-24
16	2-00-00605	4	Nut, Hex MS #10-24
17	2-00-04626	2	Female Insulated Bullet, 16 ga.
18	2-00-04578	2	Male Insulated Bullet, 16 ga.
19	3-61-00189	1	Black Wire, 16 ga. 5'
20	2-00-04200	1	Grommet
21	8-18-00425	1	Decal, Heater Fan
22	2-00-04638	1	Nipple, 3/8 x 1/2 NPT
23	2-00-04616	1	Female Pipe Elbow, 45° - 1/2 NPT
24	2-00-02474	1	Pipe Plug, 1/2 NPT

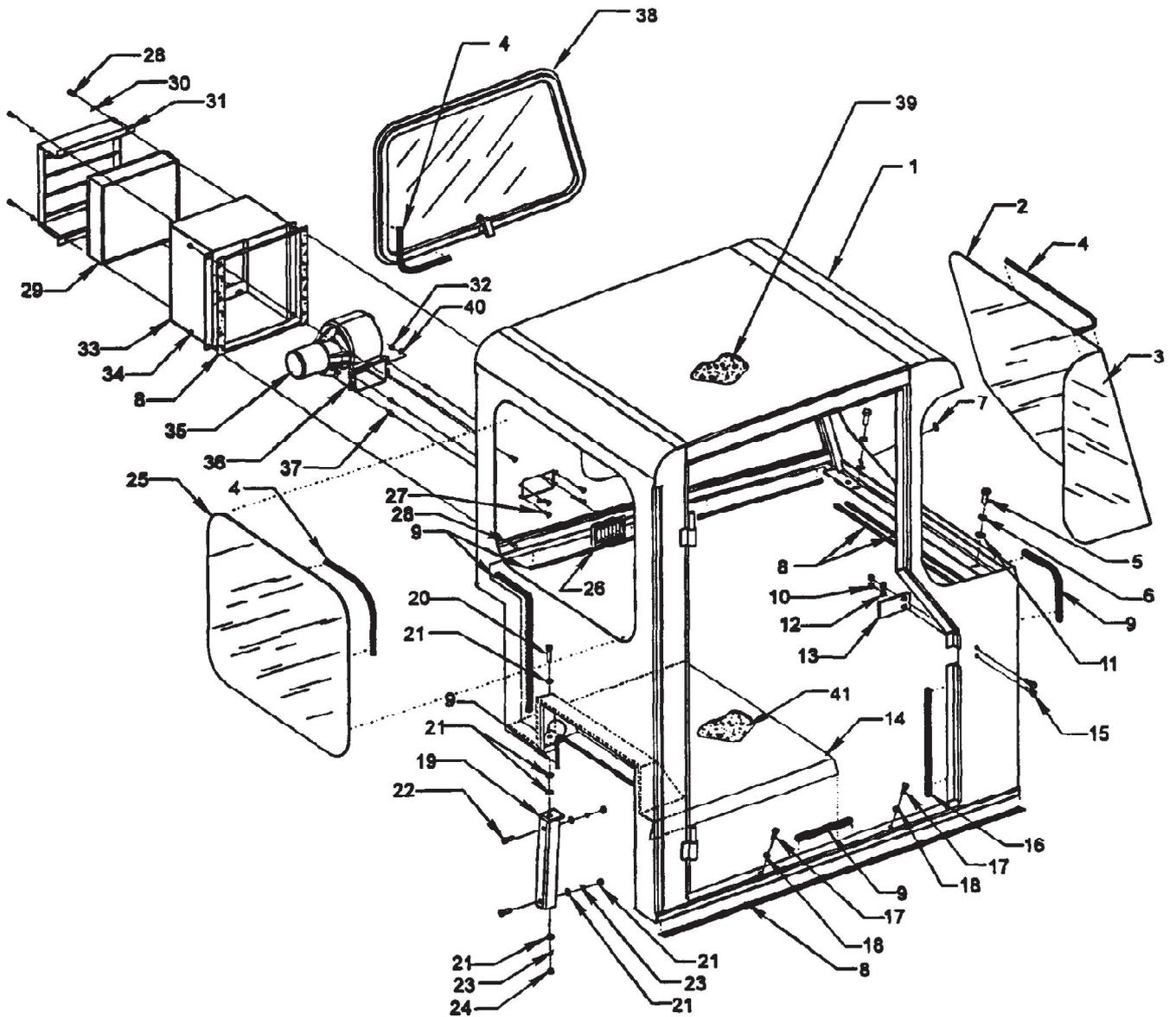

Referenznummer	Artikelnummer	Menge	Description
1	8-09-05001	1	Cab Weldment
2	8-90-01003	1	Window, Front
3	8-90-01004	1	Window, Side
4	3-73-00082	1	Seal, Glass .13 St'l x .19/.25 Glass 35'
5	2-00-00240	2	Screw, 1/2-13 x 1.250 HHC
6	2-00-02312	2	Lock Washer, 1/2 H.S. Med.
7	2-00-04604	1	Plug Button
8	3-73-00056	1	1/8 x 1/2 C.C. Spng. w/Adhesive 16'
9	3-73-00075	1	Gasket, Straight Seal 15'
10	2-00-00644	2	Nut, Hex 5/16-18 Fibre Insert
11	2-00-00405	2	Flat Washer, 1.063 x .531 x .094
12	2-00-00409	2	Flat Washer, .687 x .344 x .062
13	8-45-05009	1	Lug, Striker
14	8-16-07365	1	Seat Deck
15	2-00-00207	2	Screw, 5/16-18 x 1.250 HHC
16	3-73-00061	1	Gasket, 90 Seal 13'
17	2-00-05315	2	Screw, 1/4-14 x 1.000 TEKS
18	2-00-03702	3	Flat Washer, .625 x .281 x .063
19	8-81-00178	1	Brace
20	2-00-00234	1	Screw, 3/8-16 x 1.500 HHC
21	2-00-00402	4	Flat Washer, .750 x .390 x .094
22	2-00-00233	2	Screw, 3/8-16 x 1.000 HHC
23	2-00-02310	3	Lock Washer, 3/8 H.S. Med.
24	2-00-02360	3	Nut, Hex 3/8-16 x .562 x .328
25	8-90-01005	1	Window, Rear
26	8-18-03025	1	Adj. Louver Vent Cover
27	2-00-03042	4	Screw, 1/4-20 x 1.500 HSHC-Black
28	2-00-00221	1	Screw, 1/4-20 x .750 HHC
29	8-24-04141	1	Filter
30	2-00-00518	12	Lock Washer, 1/4 H.S. Med.
31	8-13-07134	1	Clamp, Filter
32	2-00-00594	6	Nut, Hex 1/4-20 x .437 x .218
33	8-33-05123	1	Blower Housing
34	2-00-00641	7	Nut, Fiber Insert, 1/4-20
35	0882-055	1	Motor
36	8-23-00015	1	Blower Assembly
37	8-75-01205	4	Spacer
38	8-90-01001	1	Canopy Window
39	8-34-09026	1	Cab Insulation, Top
40	2-00-00501	1	Lockwasher, 1/4 Int.
41	8-34-09019	1	Insulation Seat Deck

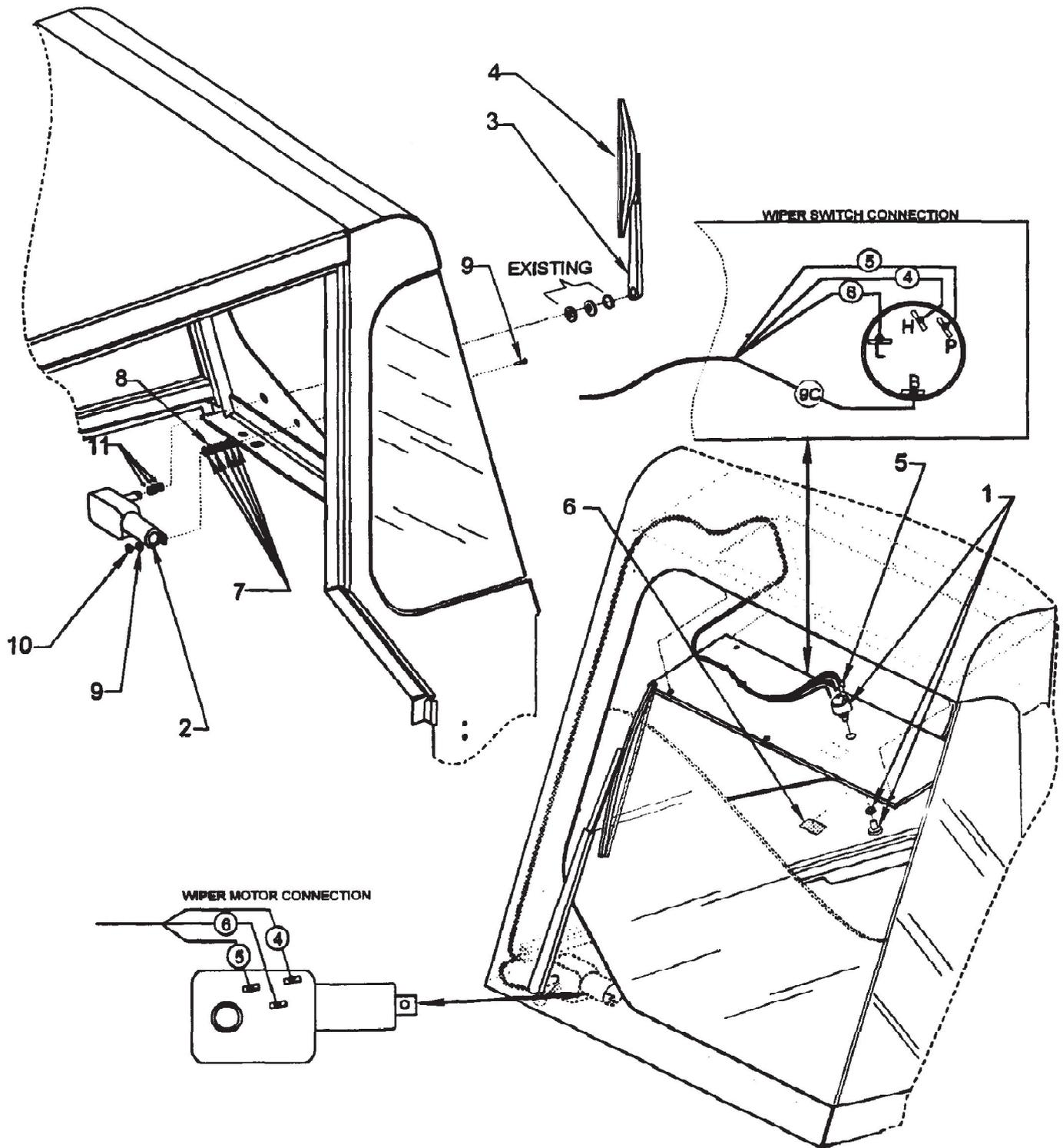

Referenznummer	Artikelnummer	Menge	Description
	0880-614		Cab Windshield Wiper Option No.
1	8-82-00061	1	Wiper Switch
2	0882-056	1	Wiper Motor
3	8-03-04315	1	Wiper Arm
4	8-06-03004	1	Wiper Blade
5	2-00-03418	3	Terminal, .25 FISO Female
6	8-18-00424	1	Decal, Windshield Wiper
7	2-00-00426	5	Flat Washer, .500 x .219 x .063
8	2-00-00605	1	Nut, Hex MS #10-24 x .375 x .125
9	2-00-00426	1	Flat Washer, .500 x .219 x .063
10	2-00-01246	1	Nut, Hex Fiber Insert #10-24
11	2-00-03170	3	Flat Washer, 1.500 x .750 x .125

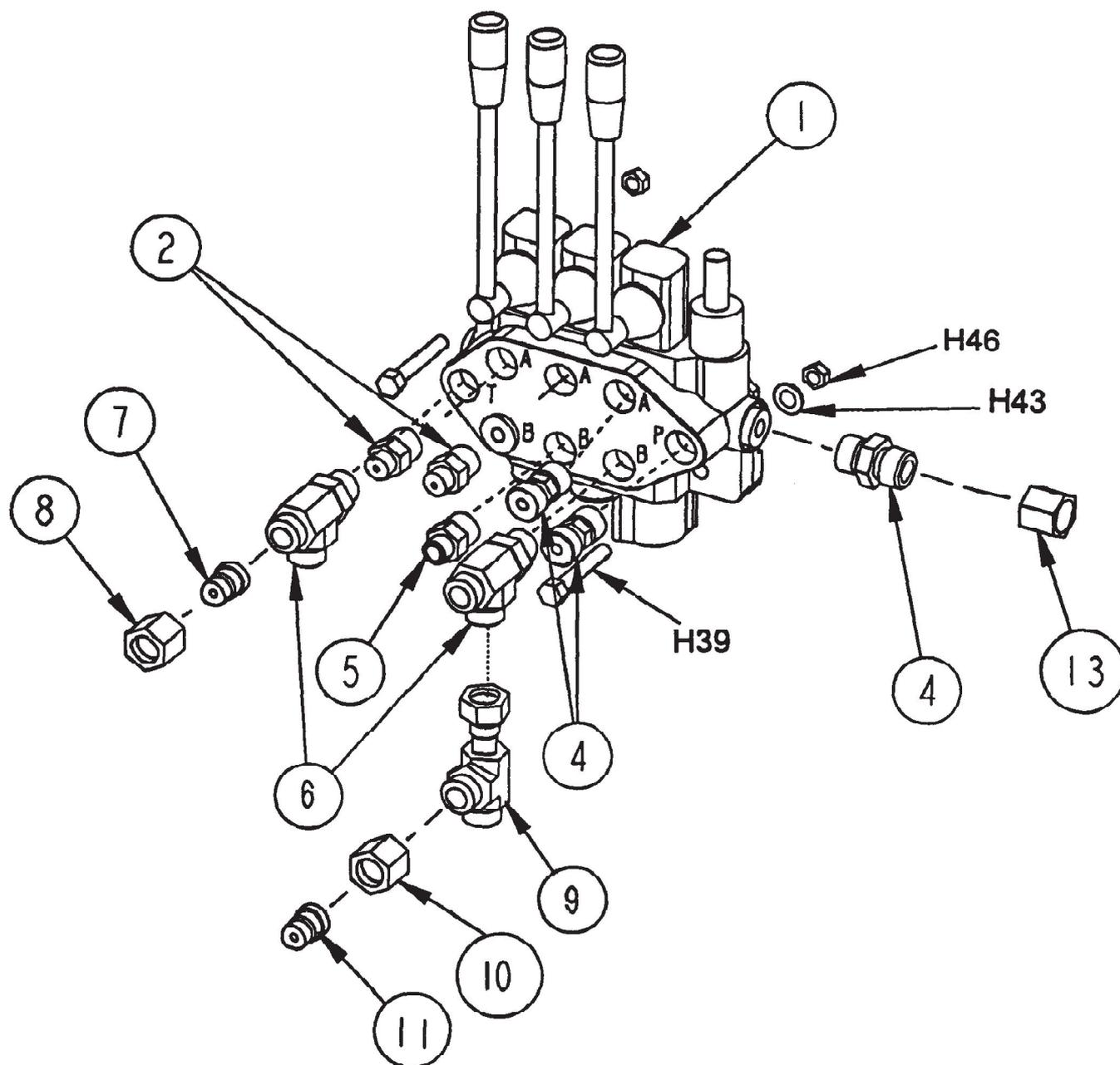

Referenznummer	Artikelnummer	Menge	Description
1	8-88-00060	1	Control Valve
	7-70-00095	Ref.	Seal Kit, Control Valve (Service Part)
	7-88-00068	Ref.	Relief Valve, Control Valve (Service Part)
2	2-00-05264	2	Fitting
4	2-00-04970	3	Fitting, Connector
5	2-00-05264	1	Fitting, Connector
6	2-00-04924	2	Fitting, Run Tee
7	2-00-04929	1	Fitting, Reducer
8	2-00-04939	1	Fitting, Nut for Reducer
9	2-00-04928	2	Fitting, Run Tee
10	2-00-04939	1	Fitting
11	2-00-04929	1	Fitting
13	2-00-04957	1	Fitting
H39	2-00-00218	2	Screw, 5/16-18 x 2.000 HHC HARDWARE
H43	2-00-00409	1	Flat Washer, .687 x .344 x .062 HARDWARE
H46	2-00-00644	2	Nut, 5/16-18, Insert Fiber HARDWARE

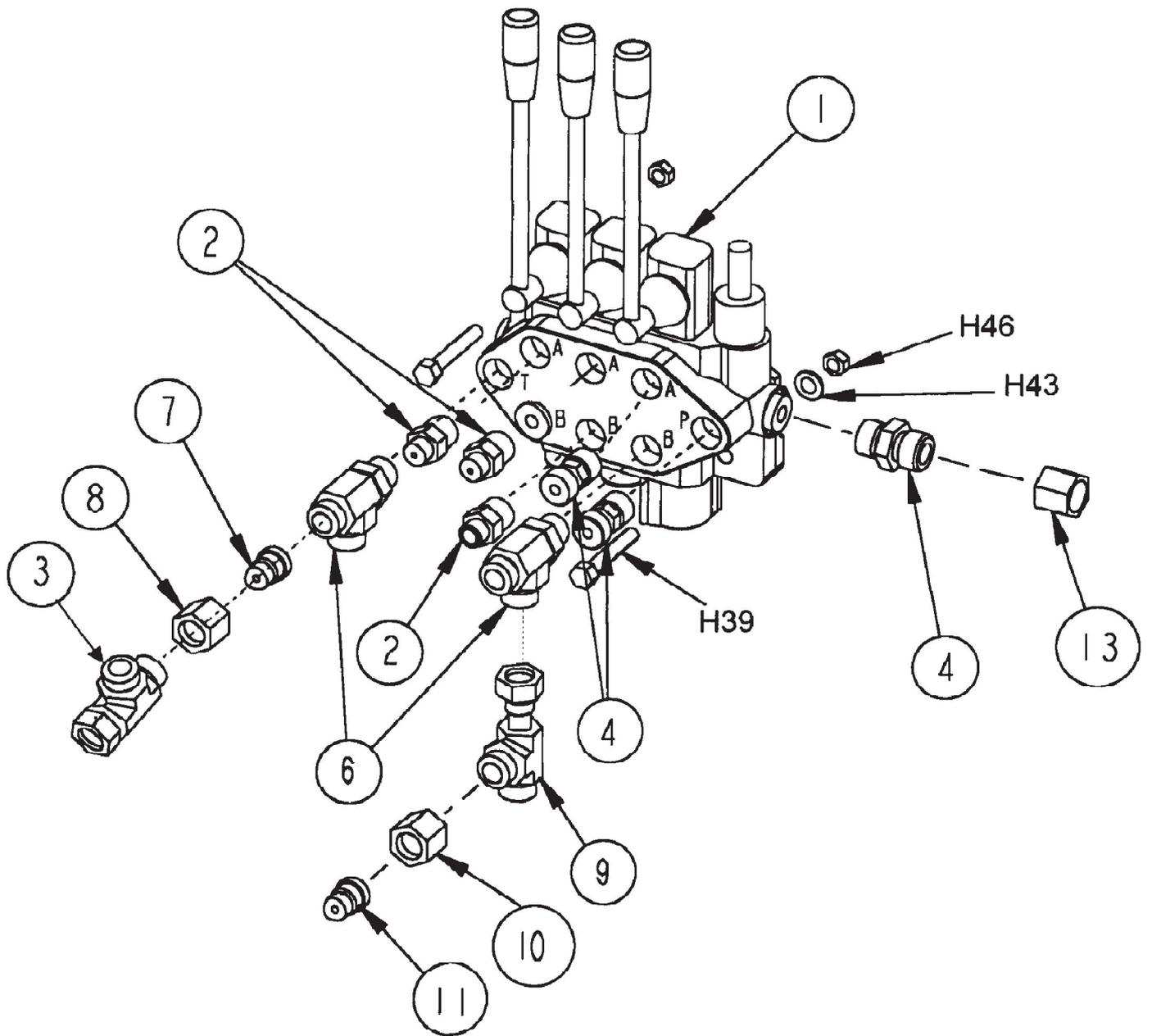

Referenznummer	Artikelnummer	Menge	Description
1	8-88-00060	1	Control Valve
	7-70-00095	Ref.	Seal Kit, Control Valve Service Part
	7-88-00068	Ref.	Relief Valve, Control Valve Service Part
2	2-00-05264	3	Fitting
3	2-00-05162	1	Fitting - Tee
4	2-00-04970	3	Fitting, Connector
6	2-00-04924	2	Fitting, Run Tee
7	2-00-04929	1	Fitting, Reducer
8	2-00-04939	1	Fitting, Nut for Reducer
9	2-00-04928	1	Fitting, Run Tee
10	2-00-04939	1	Fitting
11	2-00-04929	1	Fitting
13	2-00-04957	1	Fitting
H39	2-00-00218	2	Screw, 5/16-18 x 2.000 HHC Hardware
H43	2-00-00409	1	Flat Washer, .687 x .344 x .062 Hardware
H46	2-00-00644	2	Nut, 5/16-18, Insert Fiber Hardware

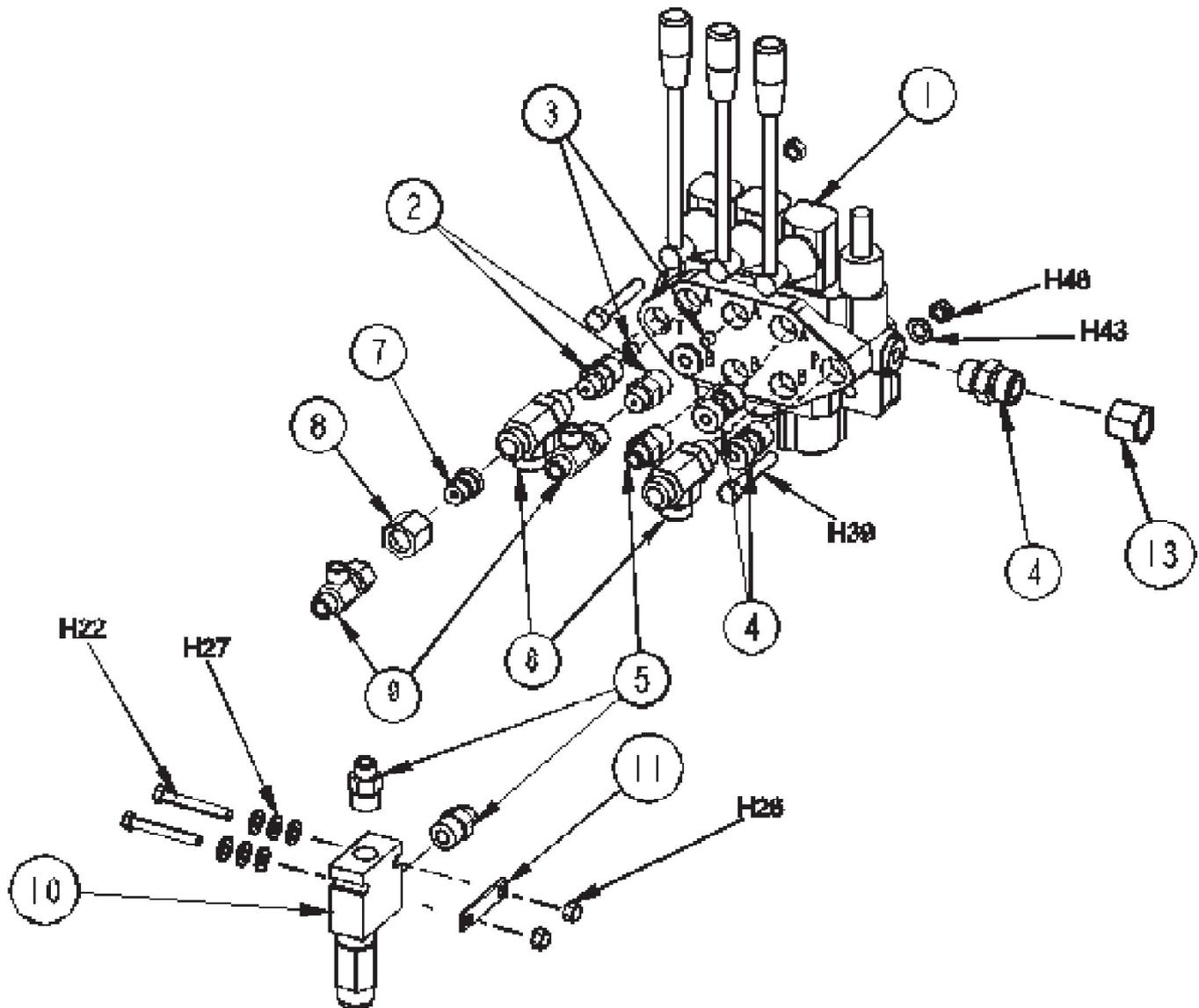

Referenznummer	Artikelnummer	Menge	Description
1	7-88-00065	1	Control Valve
	7-70-00095	Ref.	Seal Kit, Control Valve (Service Part)
	7-88-00068	Ref.	Relief Valve, Control Valve (Service Part)
2	2-00-05267	2	Fitting, Modified
3	2-00-05256	2	Orifice Plug
4	2-00-04970	2	Fitting, Connector
5	2-00-05264	1	Fitting, Connector
6	2-00-04924	2	Fitting, Run Tee
7	2-00-04929	1	Fitting, Reducer
8	2-00-04939	1	Fitting, Nut for Reducer
9	2-00-05162	2	Fitting, Run Tee
10	7-88-00060	1	Valve, Relief
	7-12-02021	Ref.	Cartridge, Relief Valve (Service Part)
11	8-08-00590	1	Bracket, Valve Mounting
13	2-00-04957	1	Fitting
H22	2-00-02589	2	Screw, 1/4-20 x 2.000 HHC
H26	2-00-00641	2	Nut, 1/4-20 Insert Fiber
H27	2-00-03702	6	Washer, .625 x .281 x .063
H39	2-00-00218	2	Screw, 5/16-18 x 2.000 HHC
H43	2-00-00409	1	Flat Washer, .687 x .344 x .062
H46	2-00-00644	2	Nut, 5/16-18, Insert Fiber

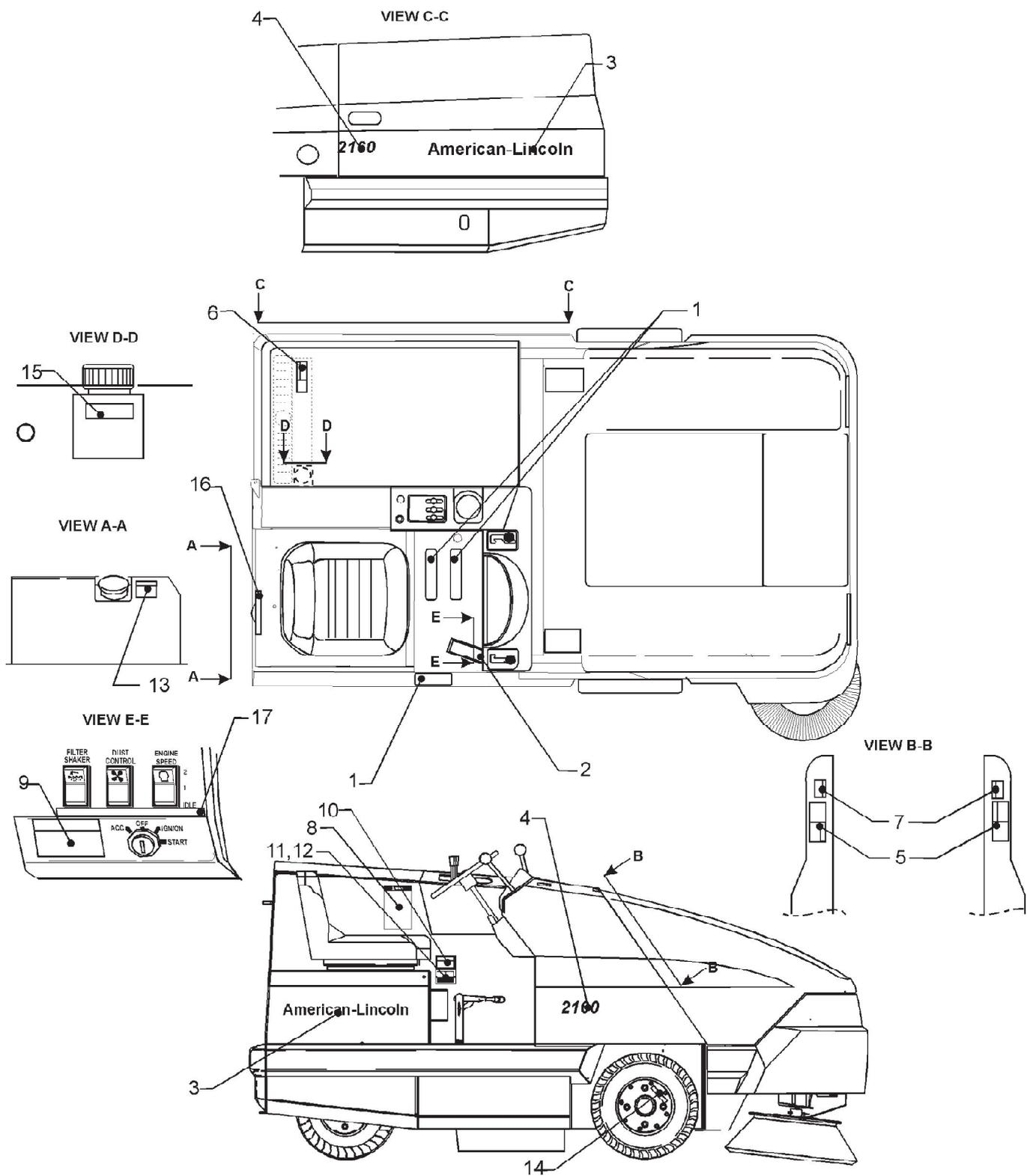

Referenznummer	Artikelnummer	Menge	Description
1	7-50-05136	3	Non-Skid
2	8-50-05055	1	Non-Skid
3	8-18-00400	2	Decal, American-Lincoln Logo
4	8-18-00401	2	Decal, 2160
4	8-18-00417	2	Decal, 2160 XP
5	8-18-00398	2	Decal, Hopper Warning
6	8-18-00399	1	Fan & Belt Warning
7	8-18-00402	2	Pinch Point Warning
8	8-18-00396	1	Decal, General Warning
9	8-18-00395	1	Key Switch Warning
10	7-18-00228	1	Patent Decal
11	8-50-00013	Ref.	Serial Tag
12	2-00-04115	2	Rivets
13	8-18-00085	1	Fuel Warning
14	7-18-00159	2	Warning Decal, Split Rim
15	8-18-00306	1	Decal, Hydraulic Fluid
16	8-18-00310	1	Decal, Gasoline Only
16	8-18-00311	1	Decal, Diesel Only
17	8-18-00426	1	Decal, Diesel Starting

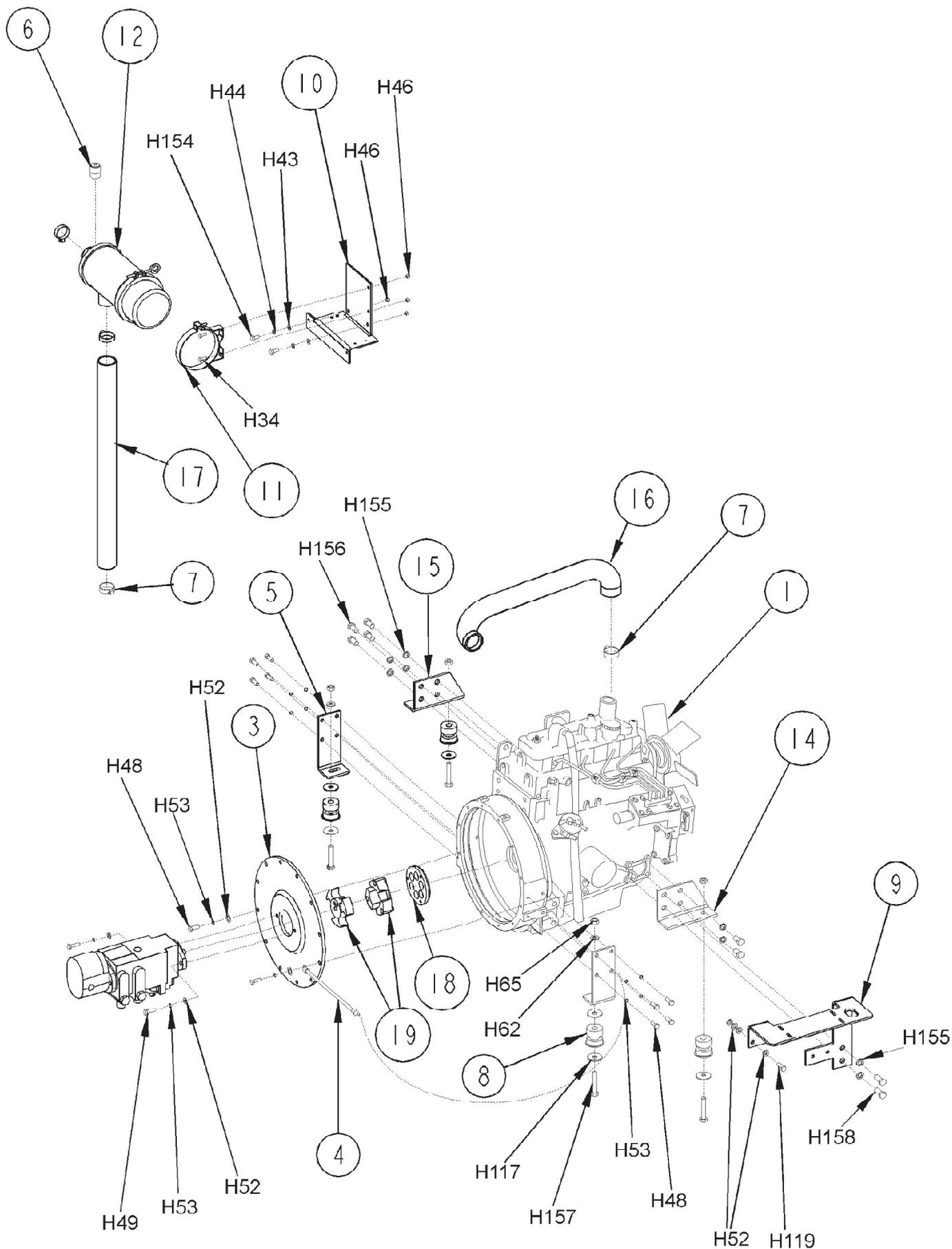

Referenznummer	Artikelnummer	Menge	Description
1	0877-048	1	Perkins Engine
3	8-33-05107	1	Pump Plate
4	8-90-07328	1	Ground Cable
5	8-08-00825	2	Bracket, Engine Mounting
6	8-24-04136	1	Indicator
7	2-00-02216	4	Hose Clamp
8	7-35-00017	4	Isolator Mount
9	8-08-00821	1	Bracket, Governor Mounting
10	7-08-00823	1	Air Cleaner Mounting Bracket
11	8-24-04093	1	Band Assembly
12	8-24-04100	1	Air Cleaner, Donaldson
14	8-08-00822	1	Bracket, Engine Mounting-Left
15	8-08-00823	1	Bracket, Engine Mounting-Right
16	8-33-02332	1	Hose
17	7-33-02026	1	Hose, A/C Inlet
18	8-58-05259	1	Adapter Plate
19	0885-088	1	Coupling
H34	2-00-00208	2	Screw, 5/16-18 x .750 HHC
H43	2-00-00409	2	Flat Washer, .687 x .344 x .062
H44	2-00-00530	2	Lock Washer, 5/16 HS Med.
H46	2-00-00644	3	Nut, 5/16-18, Insert Fiber
H48	2-00-00233	9	Screw, 3/8-16 x 1.000 HHC
H49	2-00-00209	1	Screw, 3/8-16 x 1.250 HHC
H52	2-00-00402	6	Flat Washer, .750 x .390 x .094
H53	2-00-02310	3	Lock Washer, Helical Spring 3/8 Med.
H62	2-00-00405	1	Flat Washer, 1.063 x .531 x .094
H65	2-00-04936	1	Nut, 1/2-13 Fibre Lock
H117	2-00-05067	1	Flat Washer, 1.750 x .531 x .100
H119	2-00-05005	1	Screw, M10 x 1.500 30 mm MHHC
H154	2-00-04363	2	Screw, M8-1.250 x .750
H155	2-00-05044	3	Lock Washer, M14 Split
H156	2-00-05079	1	Screw, M14 x 1.500 x 25 mm HHC
H157	2-00-00217	1	Screw, 5/16-18 x 2.000 HHC
H158	2-00-05306	2	Screw, M14 x 35 mm HHC

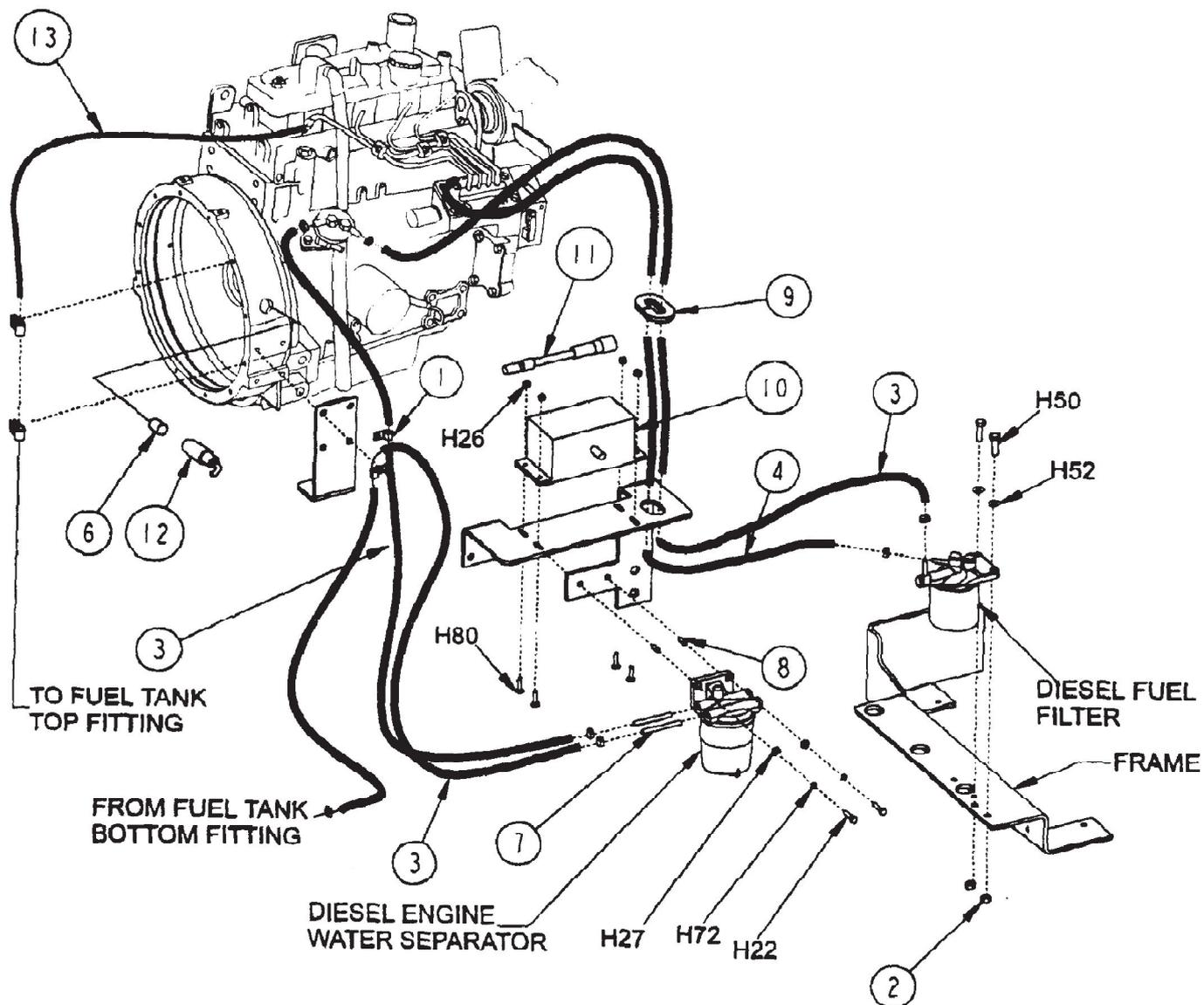

Referenznummer	Artikelnummer	Menge	Description
1	2-00-04873	4	Clamp, Hose (Single)
2	2-95-04182	2	Nut, 3/8-16 Elastic Stop
3	8-33-02145	3	Hose
4	8-33-02154	1	Hose
5	2-95-04388	12	Hose Clamp
6	8-84-08003	1	Magnetic Pick-Up
7	7-75-01098	2	Tube
8	2-00-05261	2	Threaded Insert
9	8-21-04016	1	Edging
10	8-16-00057	1	Actuator
11	8-16-00058	1	Installation Kit (Governor)
12	0875-122	1	Wire Assembly
13	8-33-02268	1	Hose
H22	2-00-02588	2	Screw, 1/4-20 x 2.000 HHC
H26	2-00-00641	4	Nut, 1/4-20 Insert Fiber
H27	2-00-03702	2	Washer, .625 x .281 x .063
H50	2-00-00234	2	Screw, 3/8-16 x 1.500 HHC
H52	2-00-00402	2	Flat Washer, .750 x .390 x .094
H72	2-00-00518	2	Lock Washer, Helical Spring
H80	2-00-02196	4	Carriage Bolt, 1/4-20 x 1.000 RHM

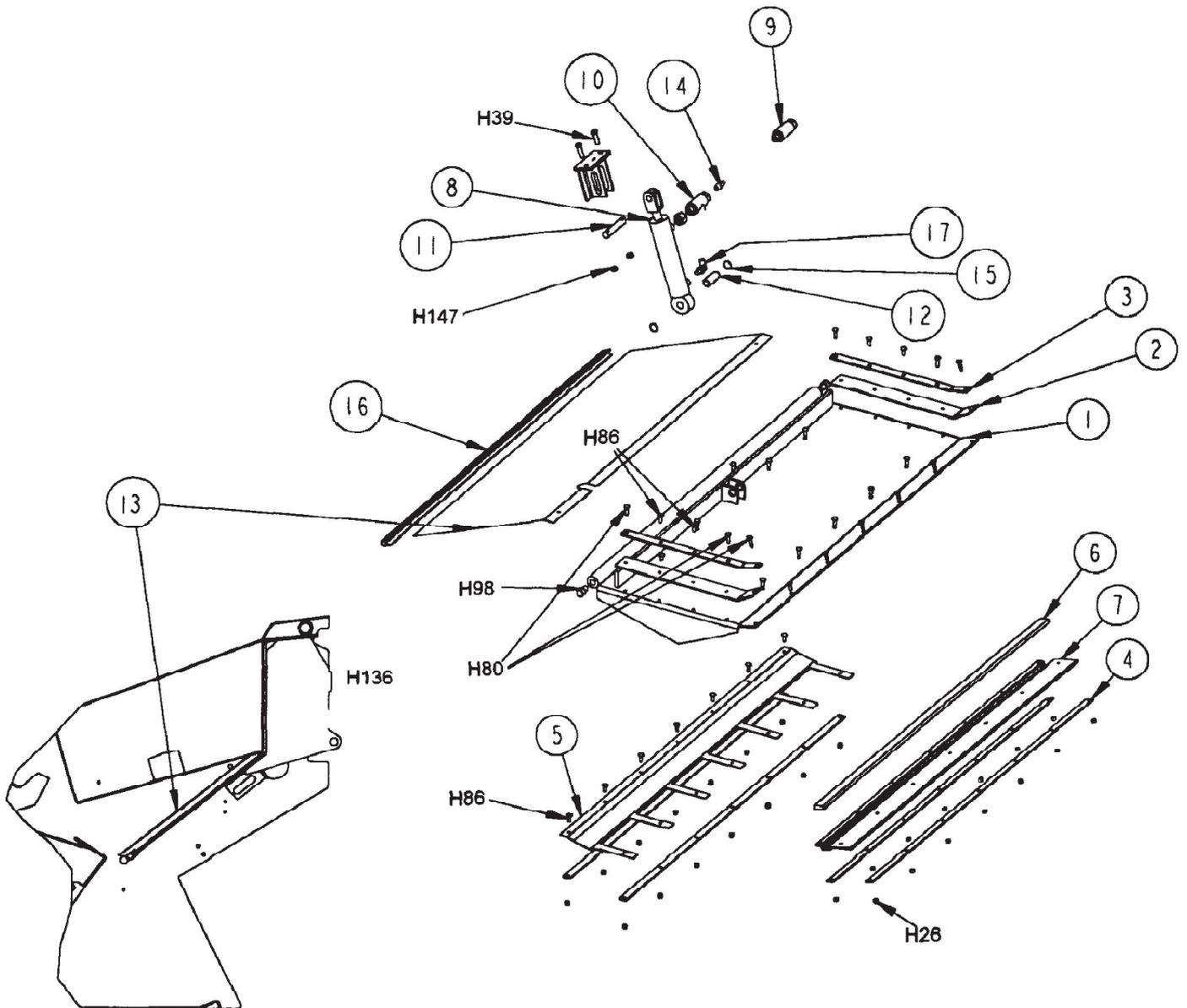

Referenznummer	Artikelnummer	Menge	Description
1	8-19-08058	1	Hopper Door
2	8-68-05075	2	Seal, Dump Door
3	8-13-07118	2	Clamp, Door Seal
4	8-13-07119	4	Clamp, Door Seal
5	8-25-08193	1	Flap, Door Vent
6	8-68-05076	1	Seal, Dump Door
7	8-68-05077	1	Seal, Dump Door
8	7-17-05011	1	Cylinder
	7-70-00021		Cylinder Seal Kit Service Part
9	8-88-00064	1	Valve
10	2-00-04895	5	Fitting, Street Tee
11	8-55-08124	1	Pin, Door Cylinder
12	8-55-08123	1	Pin, 3/4 Dia.
13	8-52-00182	1	Panel, Hopper Seal
14	2-00-04628	1	Fitting
15	2-00-00540	2	Retaining Ring, 3/4 Dia.
16	8-29-00149	1	Gasket, Dump Door
17	2-00-04892	2	Fitting
H26	2-00-00641	32	Nut, 1/4-20 Insert Fiber Hardware
H39			UNKNOWN Hardware
H80	2-00-02196	2	Carriage Bolt, 1/4-20 x 1.000 RHM Hardware
H84	2-00-00228	2	Screw, 5/16-18 x 2.250 HHC Hardware
H86	2-00-03575	30	Carriage Bolt, 1/4-20 x .750 Hardware
H98	2-00-05277	2	Screw, 1/2-13 x .750 HSHC Hardware
H136	2-00-03940	2	Screw, #10-24 x .500 T/C HH Hardware
H147	2-00-00642	2	Nut, Fibre Insert 5/18-18 Hardware

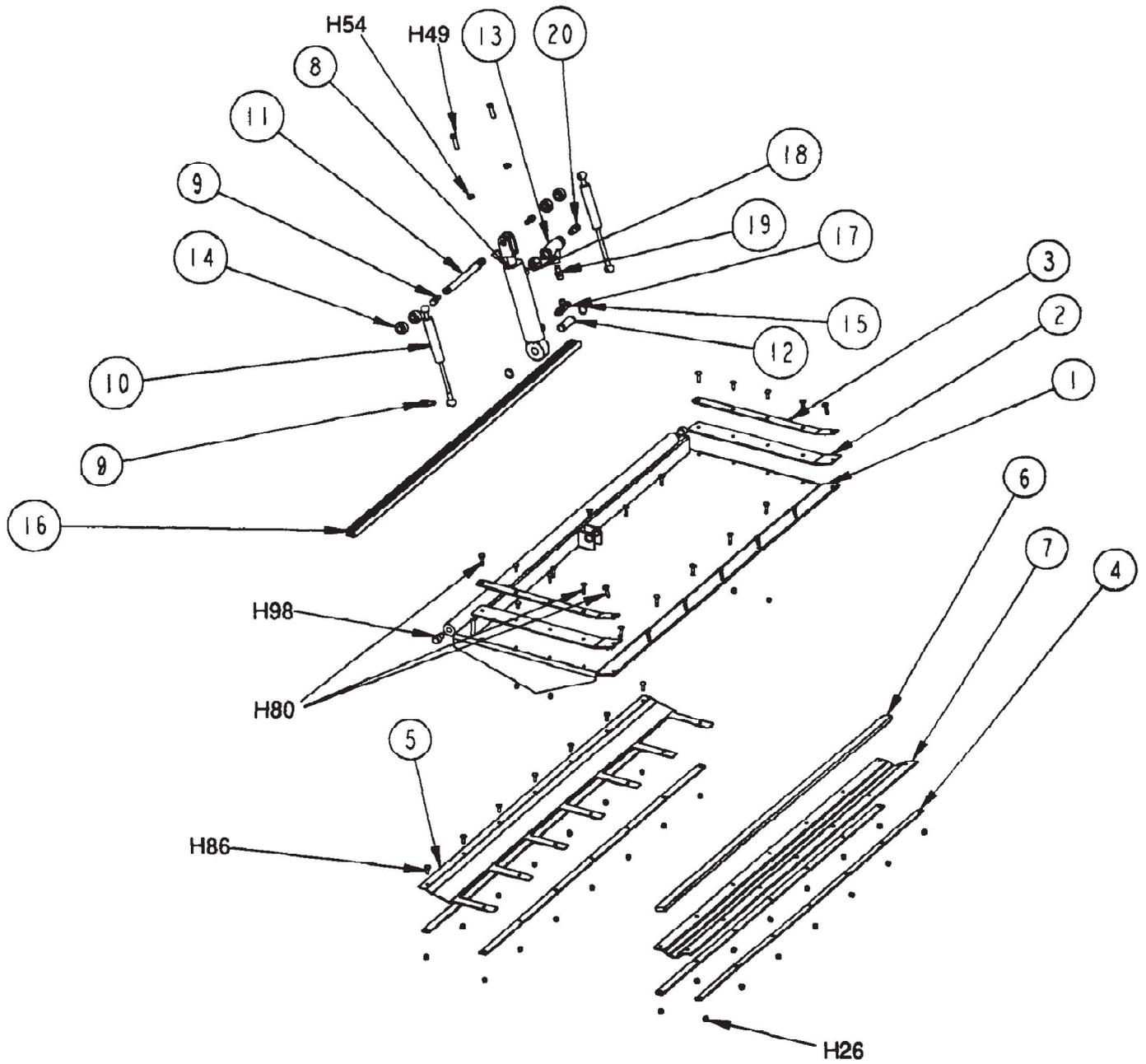

Referenznummer	Artikelnummer	Menge	Description
1	8-19-08058	1	Hopper Door
2	8-68-05075	2	Seal, Dump Door
3	8-13-07118	2	Clamp, Door Seal
4	8-13-07119	4	Clamp, Door Seal
5	8-25-08193	1	Flap, Door Vent
6	8-68-05076	1	Seal, Dump Door
7	8-68-05077	1	Seal, Dump Door
8	7-17-05011	1	Cylinder
	7-70-00021		Cylinder Seal Kit (Service Part)
9	7-80-05067	4	Ball Stud
10	8-76-00071	2	Gas Spring
11	8-55-08125	1	Pin, Door Cylinder
12	8-55-08123	1	Pin, 3/4 Dia.
13	8-88-00045	1	P.O. Checkvalve
14	8-15-01002	2	Collar
15	2-00-00540	2	Retaining Ring, 3/4 Dia.
16	8-29-00149	1	Gasket, Dump Door
17	2-00-04927	1	Fitting
18	2-00-04994	1	Fitting
19	2-00-05054	1	Fitting
20	2-00-04997	1	Fitting
H26	2-00-00641	32	Nut, 1/4-20 Insert Fiber
H49	2-00-00209	2	Screw, 3/8-16 x 1.250 HHC
H54	2-00-02360	2	Nut, 3/8-16 Hex.
H80	2-00-02196	6	Carriage Bolt, 1/4-20 x 1.000 RHM
H86	2-00-03575	6	Carriage Bolt, 1/4-20 x .7502
H98	2-00-05277	2	Screw, 1/2-13 x .750 HHC

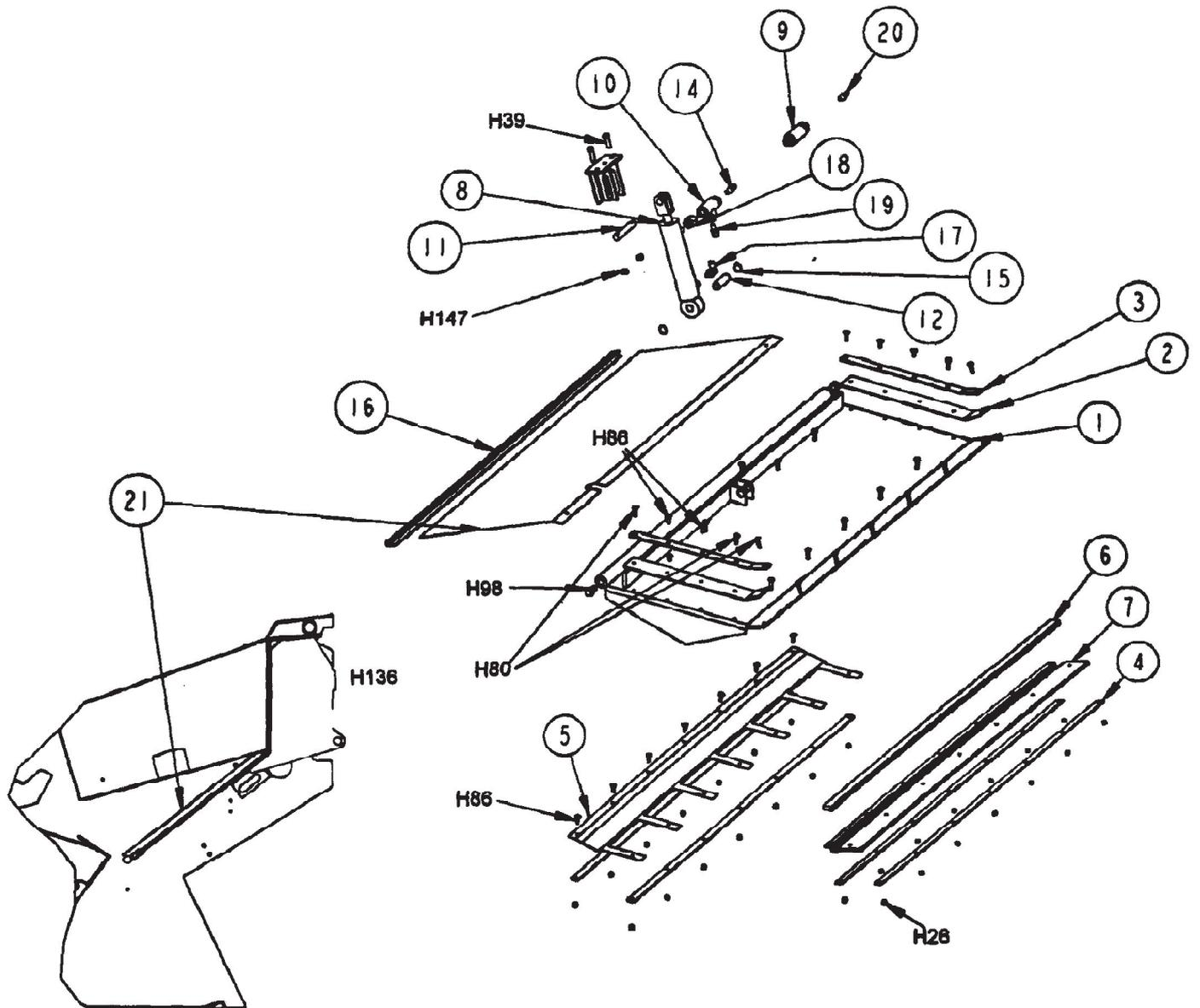

Referenznummer	Artikelnummer	Menge	Description
1	8-19-08058	1	Hopper Door
2	8-68-05075	2	Seal, Dump Door
3	8-13-07118	2	Clamp, Door Seal
4	8-13-07119	4	Clamp, Door Seal
5	8-25-08193	1	Flap, Door Vent
6	8-68-05076	1	Seal, Dump Door
7	8-68-05077	1	Seal, Dump Door
8	7-17-05011	1	Cylinder
	7-70-00021	1	Cylinder Seal Kit (Service Part)
9	8-88-00014	1	Valve
10	2-00-04462	1	Fitting, Street Tee
11	8-55-08124	1	Pin, Door Cylinder
12	8-55-08123	1	Pin, 3/4 Dia.
14	2-00-04628	1	Fitting
15	2-00-00540	2	Retaining Ring, 3/4 Dia.
16	8-29-00149	1	Gasket, Dump Door
17	2-00-04927	1	Fitting
18	2-00-04994	1	Fitting
19	2-00-05054	1	Fitting
20	2-00-04997	1	Fitting
21			UNKNOWN
H26	2-00-00641	32	Nut, 1/4-20 Insert Fiber HARDWARE
H39	2-00-00218	2	Screw, 5/16-18 x 2.000 HHC HARDWARE
H80	2-00-02196	6	Carriage Bolt, 1/4-20 x 1.000 RHM HARDWARE
H86	2-00-03575	6	Carriage Bolt, 1/4-20 x .7502 HARDWARE
H98	2-00-05277	2	Screw, 1/2-13 x .750 HHC HARDWARE
H136	2-00-03940	2	Screw, #10-24 x .500 T/C HH HARDWARE
H147	2-00-00642	2	Nut, Fiber Insert, 5/18-18 HARDWARE

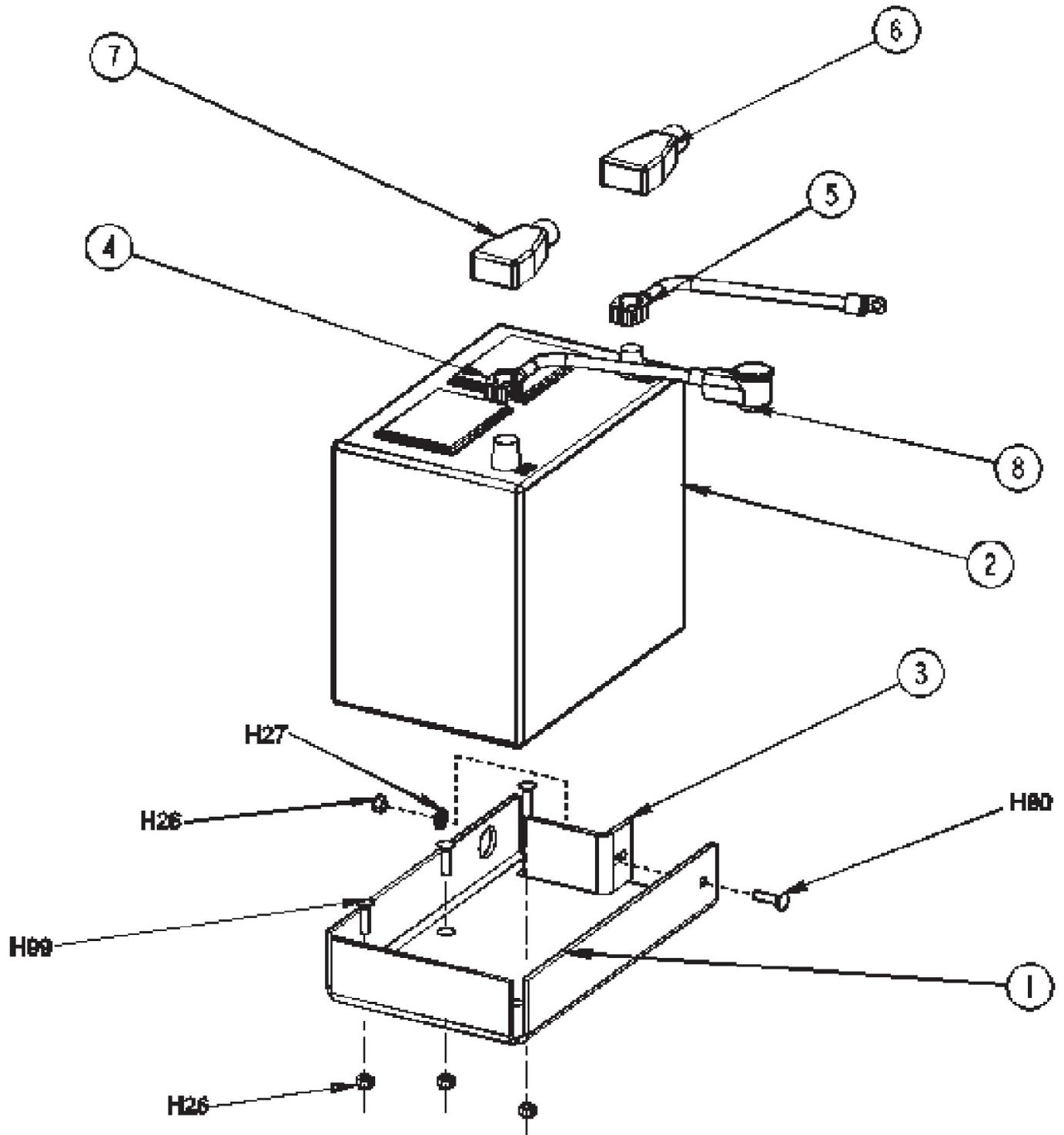

Referenznummer	Artikelnummer	Menge	Description
1	8-08-00792	1	Battery Bracket
2	0875-008	1	Battery
2	0875-057	1	Battery (Diesel)
3	7-13-07109	1	Battery Bracket
4	7-90-07280	1	Cable, Positive
5	7-90-07281	1	Cable, Negative
6	2-00-05171	1	Boot, Black
7	2-00-05173	1	Boot, Red
8	2-00-04952	1	Boot, Red
H26	2-00-00641	4	Nut, 1/4-20 Insert Fiber
H27	2-00-03702	1	Washer, .625 x .281 x .063
H80	2-00-02196	1	Carriage Bolt, 1/4-20 x 1.000 RHM
H99	2-00-02810	3	Screw, 1/4-20 x 1.000 FHM

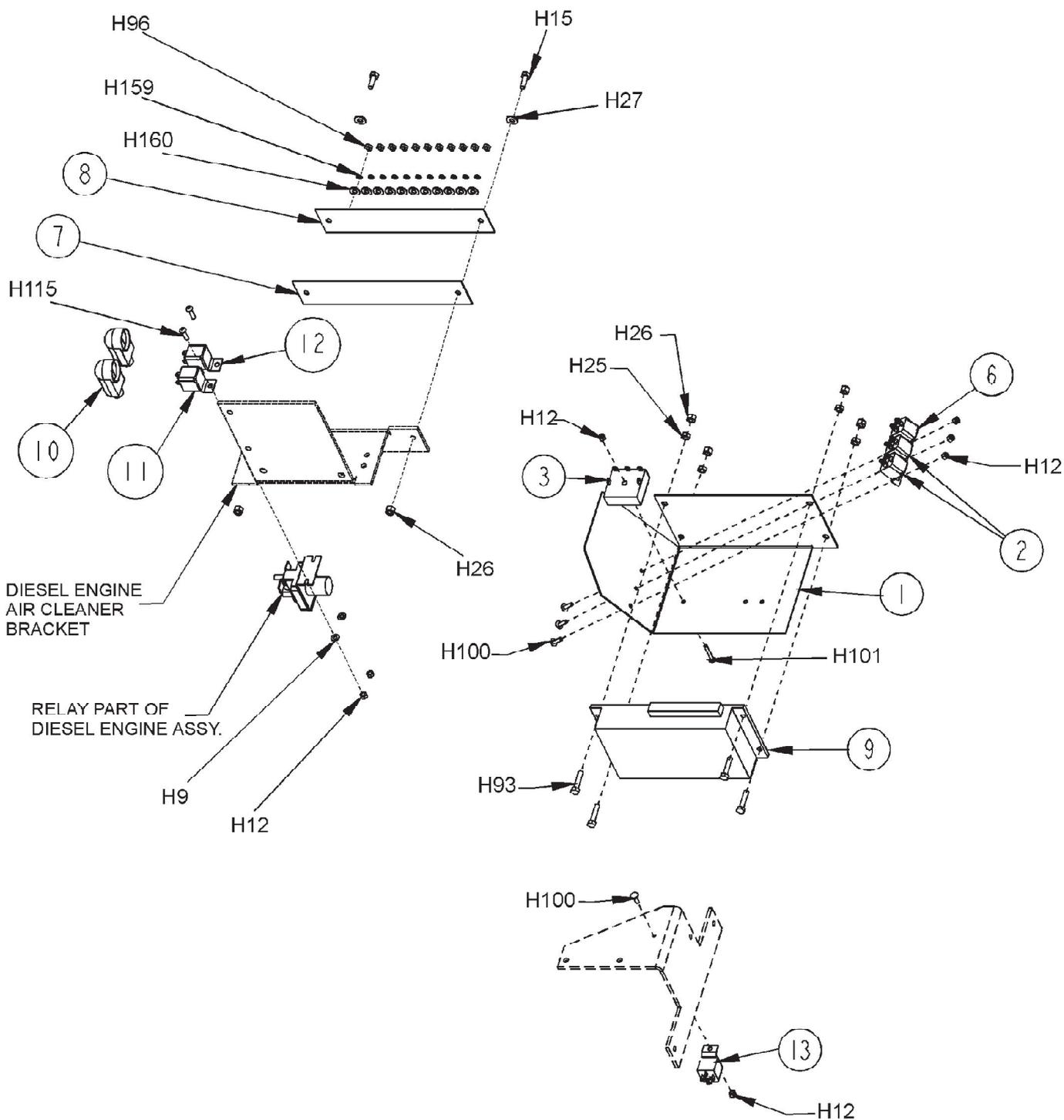

Referenznummer	Artikelnummer	Menge	Description
1	8-08-00799	1	Bracket, Relay
2	8-64-05009	2	Relay
3	8-64-05010	1	Time Delay
4	0875-116	1	Diode Assembly
5	0895-109	1	Harness, Governor/Relay
6	8-64-00012	1	Relay
7	8-58-05279	1	ID Plate
8	8-06-05007	1	Terminal Strip
9	8-16-00056	1	Controller Speed
10	2-00-04203	1	Boot
11	8-64-00012	1	Relay
12	8-64-05009	1	Relay
13	8-64-05009	1	Relay
H9	2-00-00426	2	Flat Washer, .500 x .219 x .063
H12	2-00-01246	6	Nut, Hex Fiber Insert #10-24
H15	2-00-00221	2	Screw, 1/4-20 x .750 HHC
H25	2-00-00594	4	Nut, Hex 1/4-20 x .437 x .218
H26	2-00-00641	6	Nut, 1/4-20 Insert Fiber
H27	2-00-03702	2	Washer, .625 x .281 x .063
H93	2-00-00222	4	Screw, 1/4-20 x 1.250 HHM
H96	2-00-02605	11	Screw, 3/8-16 x 4.500 HHC, Cadium Plated
H100	2-00-03062	3	Screw, #10-24 x .625 THM
H101	2-00-04897	1	Screw, #10-24 x 1.250 THM
H115	2-00-03063	2	Screw, #10-24 x .750 THM
H159	2-00-00512	11	Lock Washer
H160	2-00-00441	11	Flat Washer, .438 x .200 x .036

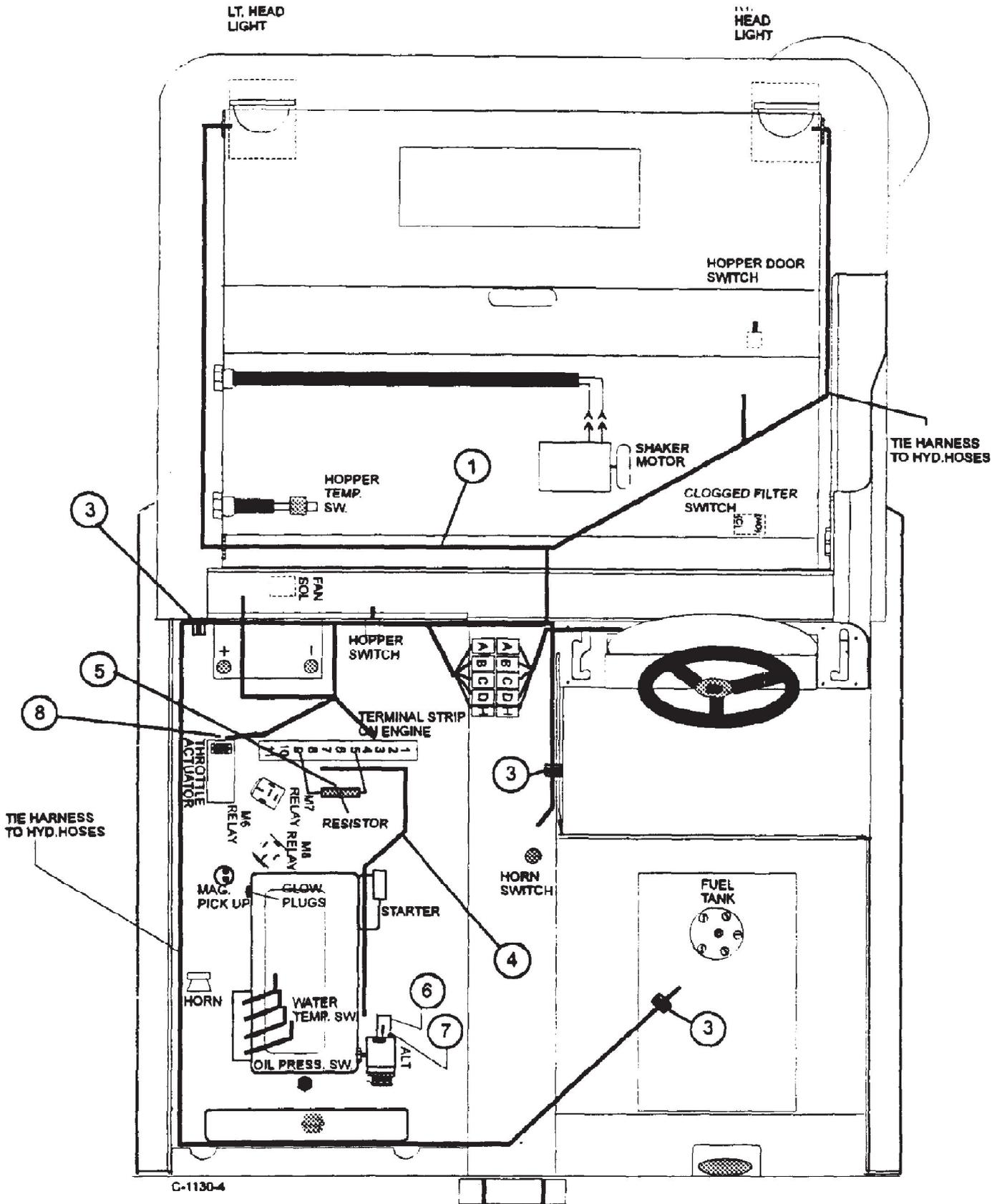

Referenznummer	Artikelnummer	Menge	Description
1	0895-110	1	Body Harness
3	7-13-07096	3	Clamp
4	0895-114	1	Engine Harness
5	0875-121	1	Resistor Assy.
6	0895-092	1	Diode, Harness
7	2-00-04203	1	Boot
8	2-00-04551	1	.156 Bullet Connector

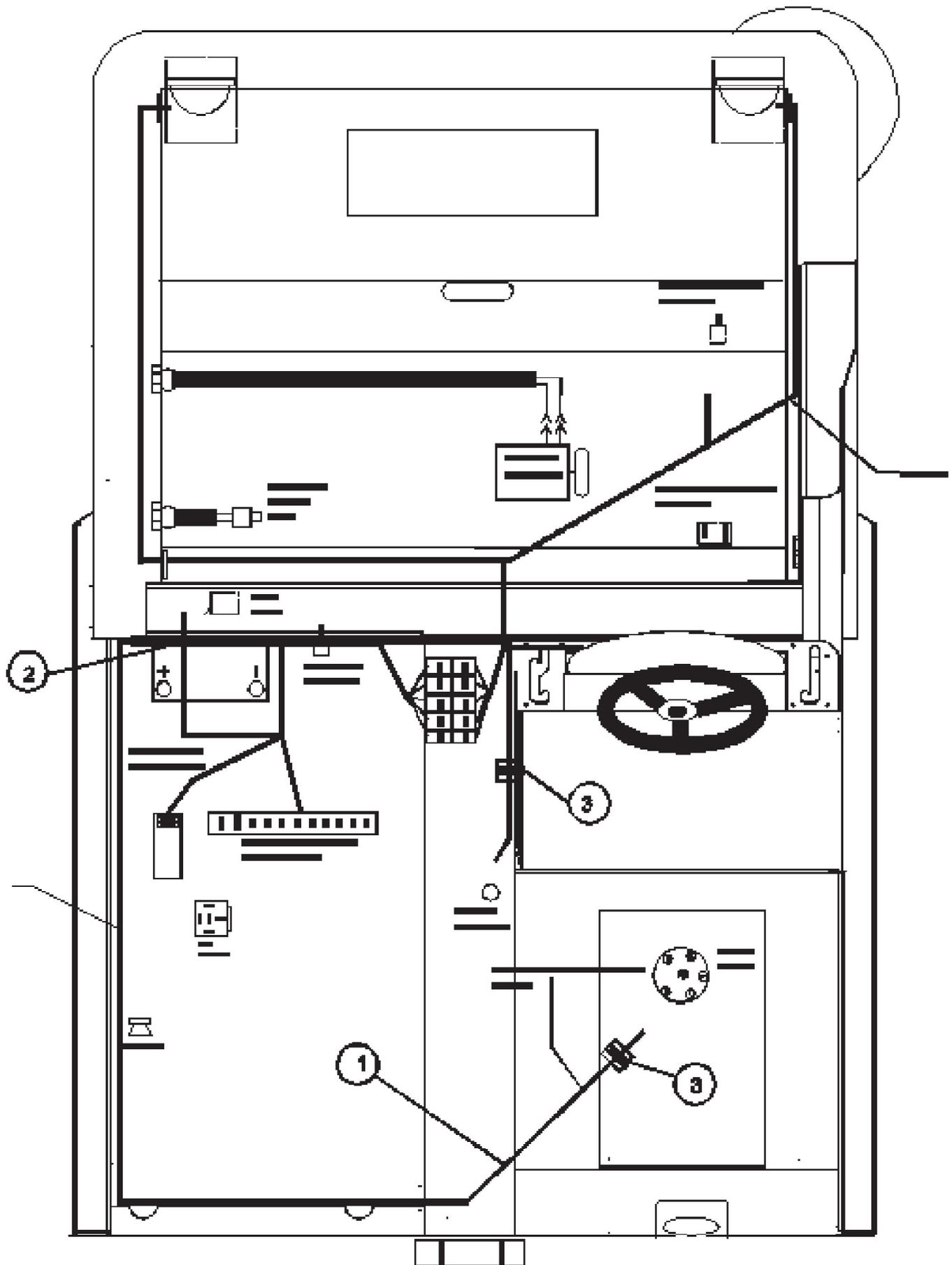

Referenznummer	Artikelnummer	Menge	Description
1	0895-110	1	Body Harness
2	8-20-06036	1	Wire, Duct
3	7-13-07096	2	Clamp

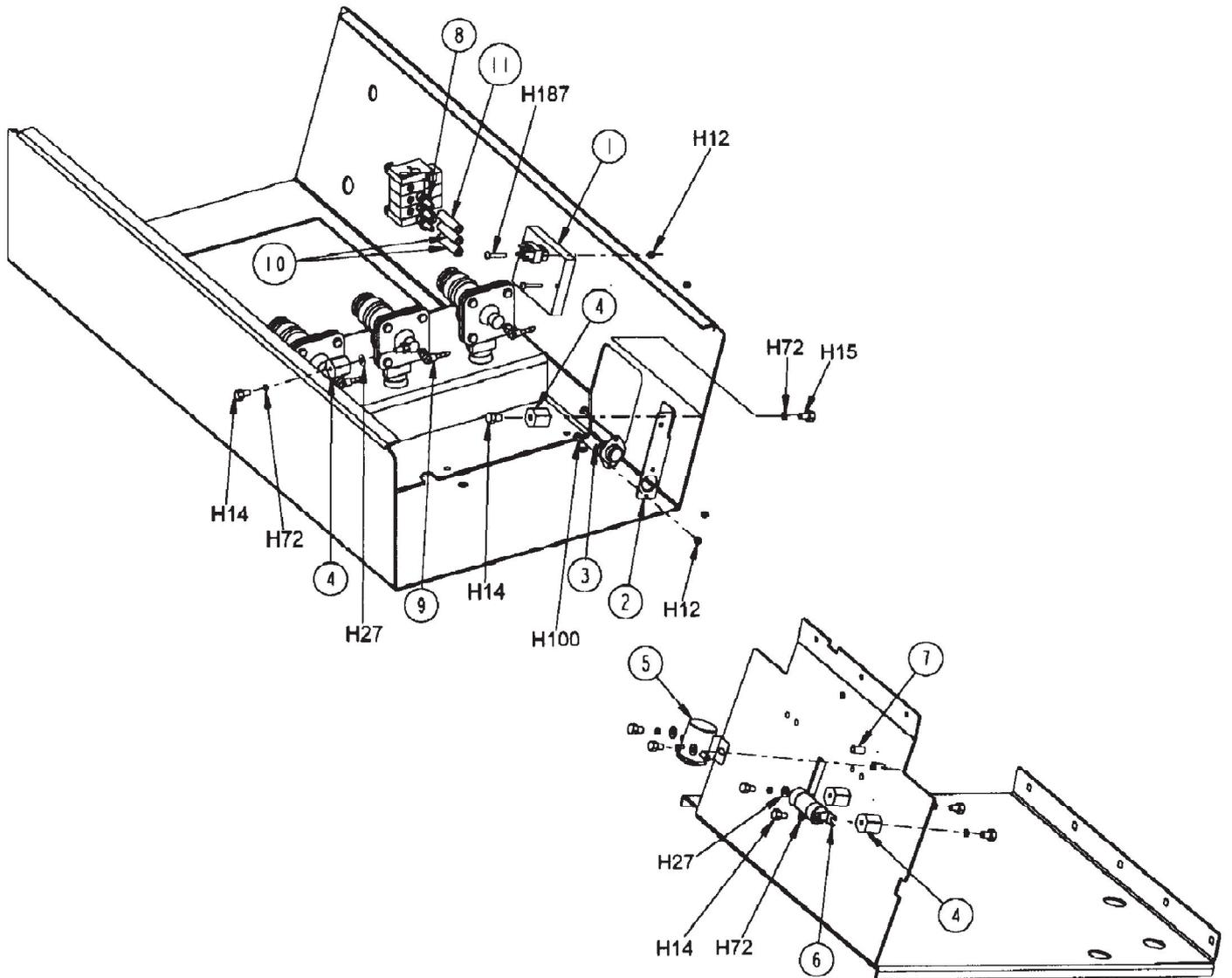

Referenznummer	Artikelnummer	Menge	Description
1	8-64-00016	1	Relay
2	8-08-00859	1	Bracket - Temp SW
3	8-82-00056	1	SW - Temp
4	8-35-00021	4	Isolator
5	7-74-00002	1	Solenoid
6	7-28-00002	1	Fuse - 80 Amp
7	2-00-05261	2	1/4 - 20 THD Insert
8	2-00-04518	3	Fitting - 1/8 NPT Straight
9	2-00-04787	3	Fitting - 1/8 NPT Ell
10	3-71-00082	2	Hose (6" Lg.)
11	3-71-00082	1	Hose (12" Lg.)
H12	2-00-01246	2	Nut, Hex Fiber Insert #10-24 Hardware
H14	2-00-00219	17	Screw, 1/4-20 x .500 HHC Hardware
H15	2-00-00221	1	Screw, 1/4-20 x .750 HHC Hardware
H27	2-00-03702	9	Washer, .625 x .281 x .063 Hardware
H72	2-00-00518	17	Lock Washer, Helical Spring Hardware
H100	2-00-03062	2	Screw, #10-24 x .625 THM Hardware
H187	2-00-00071	2	Screw, #10-24 x 1.250 RHM Hardware

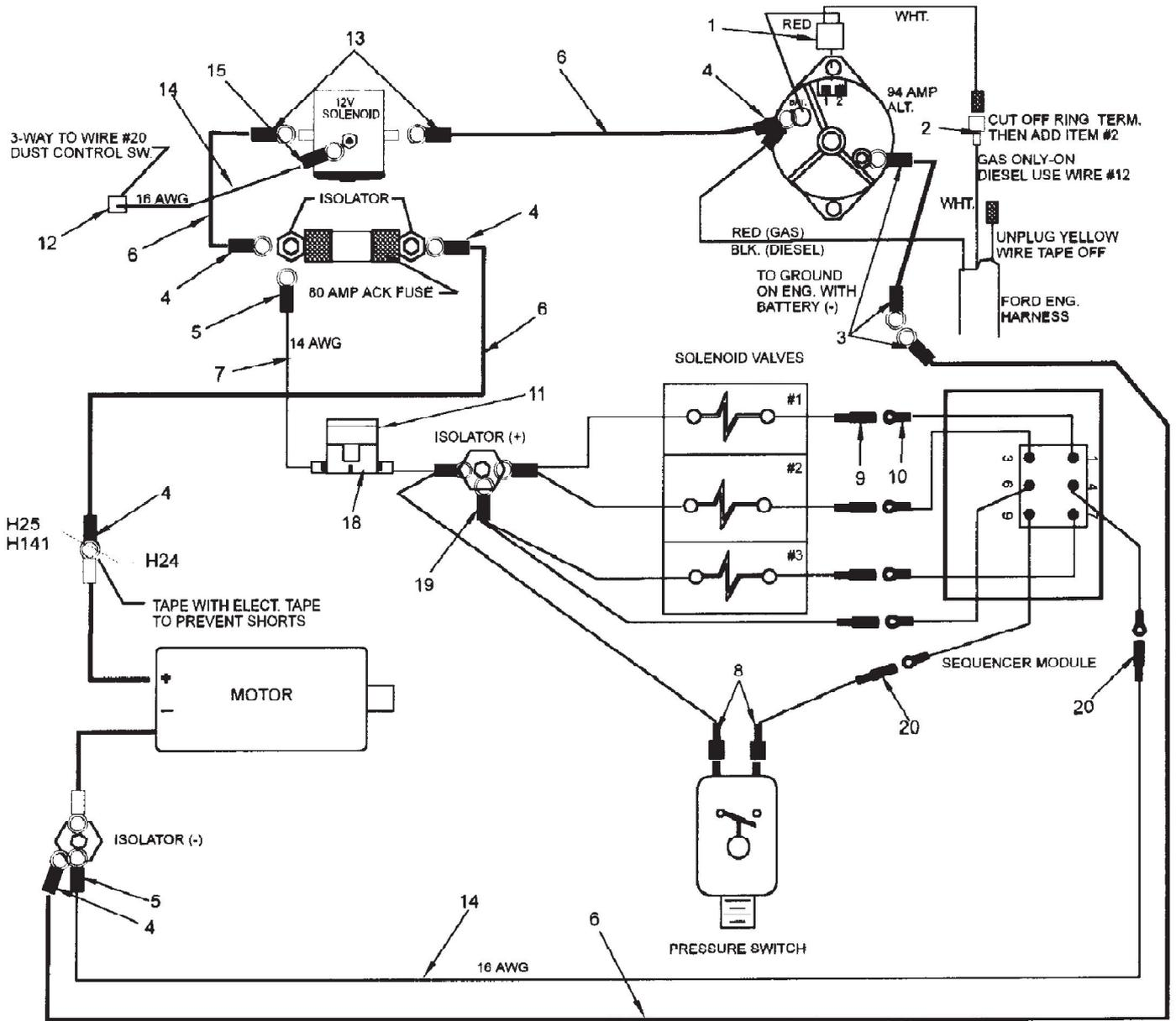

Referenznummer	Artikelnummer	Menge	Description
1	0895-092	1	Harness Assy - Wire
2	2-00-00849	1	Terminal, .25
3	2-00-04738	3	Terminal, .38 Ring
4	2-00-04659	5	Terminal, .25 Ring
5	2-00-04284	2	Terminal, .31 Ring
6	3-61-00021	15'	Wire 6 Awg. Black
7	3-61-00144	10'	Wire 14 Awg. Black
8	2-00-03418	2	Terminal, .25 FISO
9	2-00-04584	4	Terminal, .156 Female Bullet
10	2-00-04578	6	Terminal, .156 Male Bullet
11	8-28-05020	1	Fuse, 5 Amp ATC
12	2-00-04479	1	Terminal, 3-Way
13	2-00-04657	2	Terminal, .31 Ring
14	3-61-00189	5'	Wire 16 Awg. B1ack
15	2-00-04281	1	Terminal, #10 Ring
16	0875-121	1	Resistor Assembly
17	2-00-04345	10	Tye Raps
18	7-32-03019	1	In-Line Fuse Holder
19	2-00-01862	3	Terminal, .25 Ring
20	2-00-04626	2	Terminal, .156 Male Bullet
H24	2-00-00220	1	Screw, 1/4-20 x .625 HHC Hardware
H25	2-00-00594	1	Nut, Hex 1/4-20 x .437 x .218 Hardware
H141	2-00-00501	1	Lock Washer, Int. Hardware

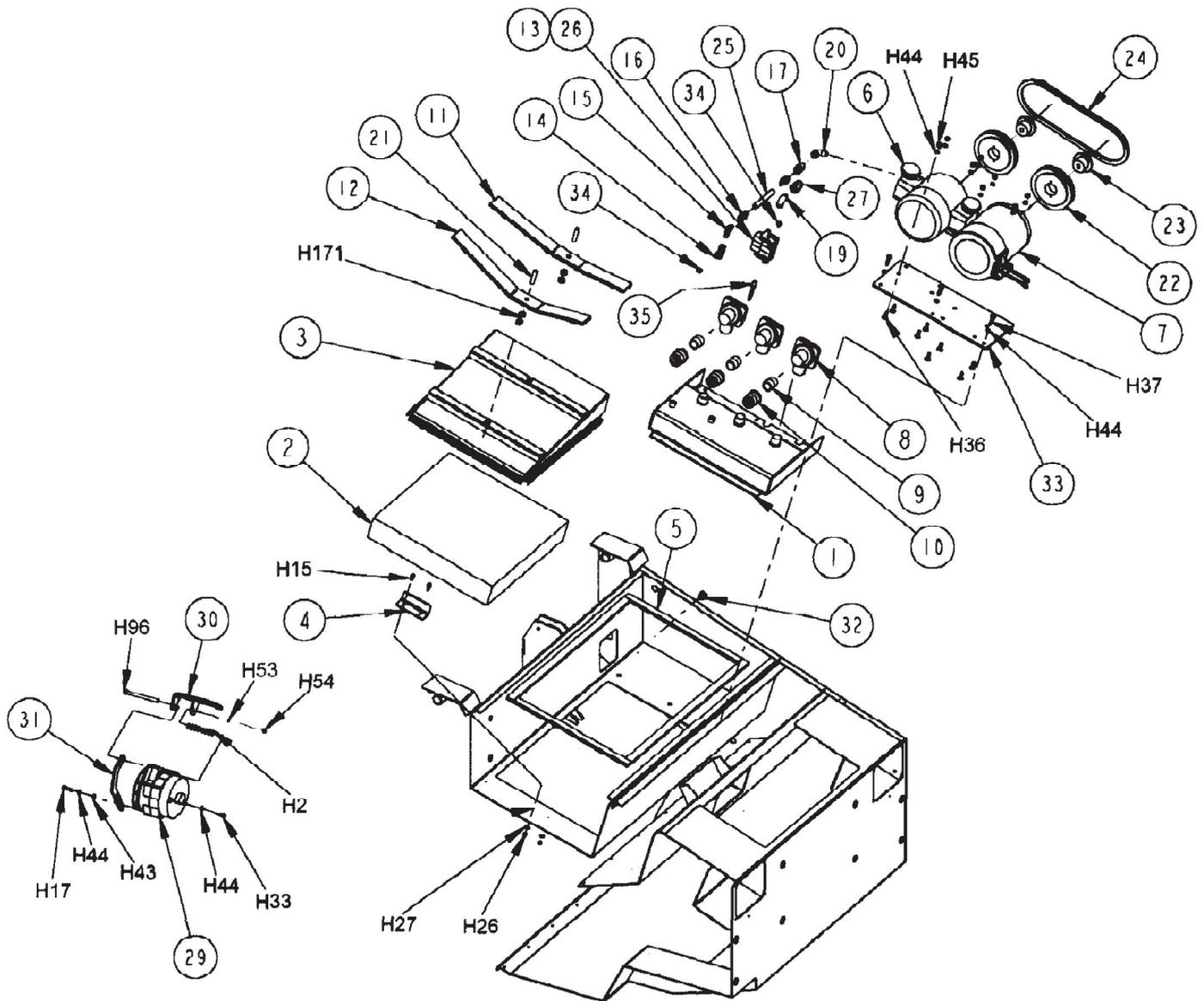

Referenznummer	Artikelnummer	Menge	Description
1	8-48-00020	1	Manifold (Weldment)
2	8-24-04145	1	Filter
3	8-20-06040	1	Filter Duct (Weldment)
4	8-78-05024	1	Stop
5	3-73-00050	6	Gasket, (4pcs)
6	0890-006	1	Compressor
7	0782-091	1	Motor
8	8-88-00061	3	Valve - Pilot Operated
9	8-56-05080	3	Fitting - 1" NPT Close Nipple
10	2-00-03859	3	Fitting - Reducer 1 - 3/4" NPT
11	8-13-07149	1	Clamp - Filter Duct (LH)
12	8-13-07150	1	Clamp - Filter Duct (RH)
13	8-88-00062	3	Valve
14	2-00-04515	1	Fitting - Tee (1/4 STR)
15	2-00-04477	1	Fitting - 90 ELL
16	2-00-04856	2	Fitting
17	2-00-05001	1	Fitting
19	8-56-05061	1	Fitting - 90 STR EL
20	8-56-05008	1	Fitting
21	8-80-05045	2	Stud
22	8-60-00165	1	Pulley
23	8-60-00171	1	Bushing
24	2-00-01064	1	Belt
25	8-33-02335	1	Hose - Compressor to Manifold
26	8-58-05787	1	End Plate Assy
27	8-82-00063	1	Pressure Switch
29	8-03-03007	1	Alternator - 12V - 94 Amp
30	7-08-00736	1	Bracket
31	7-03-04131	1	Alternator Arm
32	8-09-01082	1	Bushing
33	8-58-05786	1	Plate, Comp Mtg
34	2-00-02471	2	Plug, 1/4 NPT
35	8-25-02037	1	Fitting
H2			UNKNOWN
H15	2-00-00221	2	Screw, 1/4-20 x .750 HHC Hardware
H17	2-00-00205	1	Screw, 1/4-20 x 1.000 HHC Hardware
H26	2-00-00641	2	Nut, 1/4-20 Insert Fiber Hardware
H27	2-00-03702	2	Washer, .625 x .281 x .063 Hardware
H33	2-00-00224	1	Screw, 5/16-18 x .500 HHC Hardware
H36	2-00-00196	8	Carriage Bolt, 5/16-18 x 1.000 Hardware
H37	2-00-00207	3	Screw, 5/16-18 x 1.250 HHC Hardware
H43	2-00-00409	1	Flat Washer, .687 x .344 x .062 Hardware
H44	2-00-00530	11	Lock Washer, 5/16 HS Med. Hardware
H45	2-00-00585	8	Nut, Hex. 5/16-18 x .500 x .265 Hardware
H53	2-00-02310	1	Lock Washer, Helical Spring 3/8 Med. Hardware
H54	2-00-02360	1	Nut, 3/8-16 Hex. Hardware
H96	2-00-02605	1	Screw, 3/8-16 x 4.500 HHC, Cadium Plated Hardware
H171	2-00-02371	4	Nut, Hex Jam .50-13 STL. Hardware

Referenznummer	Artikelnummer	Menge	Description
1	8-16-07349	1	Engine Cover
1	8-16-07363	1	Engine Cover (Diesel)
2	8-08-00776	1	Engine Cover Mounting Plate
3	8-41-00051	1	Rotor Latch
4	8-39-00014	1	Latch Knob
5	7-21-03003	1	Edging
6	8-66-05012	1	Roller, Engine Cover Guide
7	2-95-04182	2	Nut, Fiber 3/8-16
8	8-29-00236	1	Gasket, Engine Cover
9	8-29-00237	1	Gasket, Engine Cover
10	2-00-05266	1	Clevis Pin
11	2-00-05249	1	Cotter Pin
12	8-34-09020	1	Insulation
13	8-34-09021	1	Insulation
H15	2-00-00221	1	Screw, 1/4-20 x .750 HHC
H26	2-00-00641	2	Nut, 1/4-20 Insert Fiber
H52	2-00-00402	1	Flat Washer, .750 x .390 x .094
H65	2-00-04936	1	Nut, 1/2-13 Fibre Lock
H72	2-00-00518	1	Lock Washer, Helical Spring
H78	2-00-05187	2	Carriage Bolt, 3/8-16 x 1.250
H92	2-00-04801	1	Flat Washer, .875 x .375 x .125
H93	2-00-00222	1	Screw, 1/4-20 x 1.250 HHM

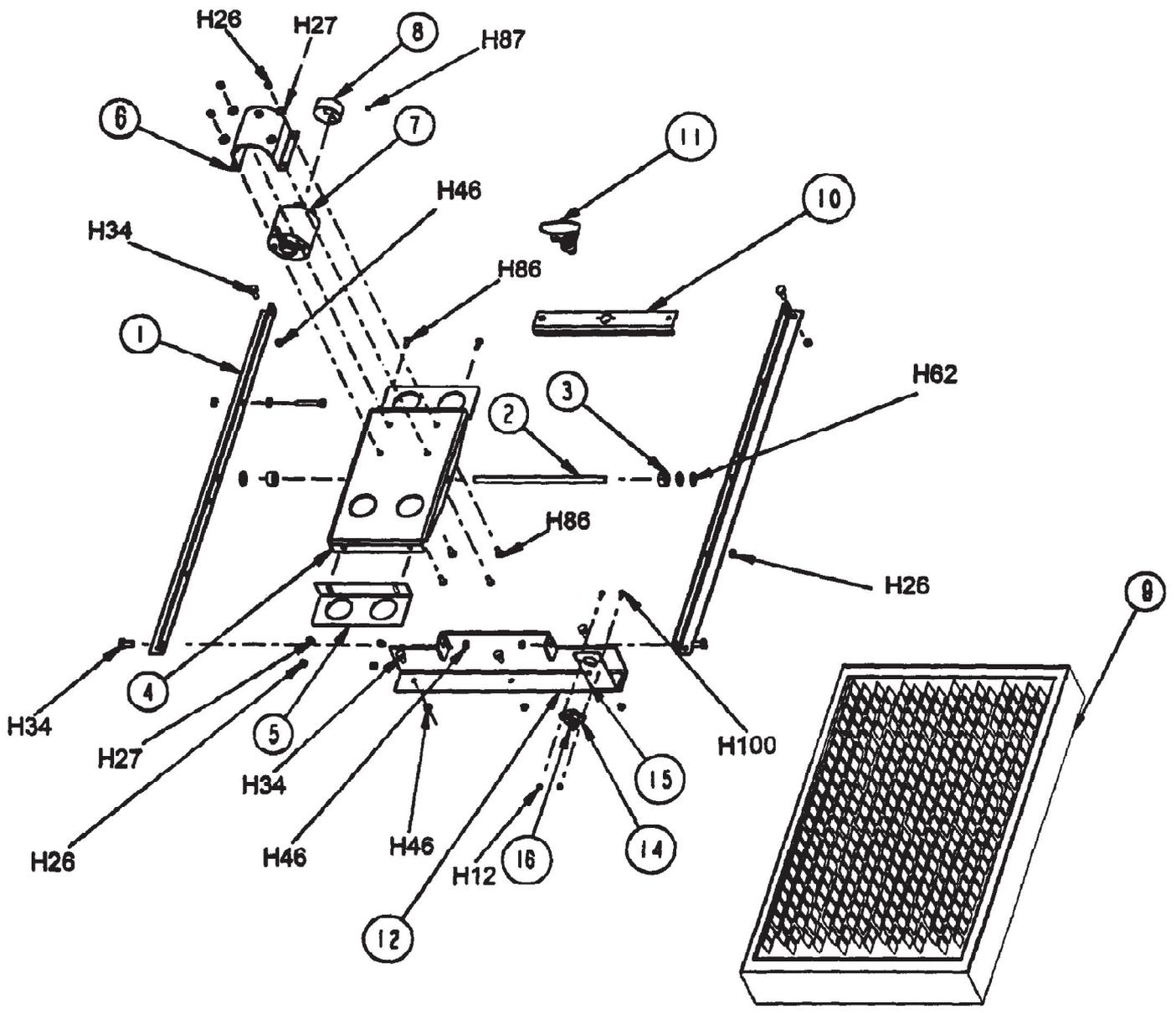

Referenznummer	Artikelnummer	Menge	Description
1	8-13-07136	2	Clamp, Filter
2	8-55-08119	1	Pin, Shaker Pivot
3	8-15-01016	2	1/2" Stop Collar
4	8-58-05273	1	Plate, Shaker
5	8-03-04302	1	Arm, Shaker
6	8-16-07181	1	Filter Shaker Motor Cover
7	0882-053-1	1	Filter Shaker Motor
8	8-89-04017	1	Brush Balancing Weights
9	8-24-04139-1	1	Filter
10	8-13-07121	1	Mounting Angle, Shaker
11	8-41-00053	1	Latch
12	8-08-00786	1	Mounting Angle, Shaker
13	8-90-07433	1	Wire, Hopper Shaker Not Shown
14	8-82-00056	1	Switch, Thermostat
15	8-08-00803	1	Bracket, Switch
16	8-90-07432	1	Wire, Hopper Thermostat
H12	2-00-01246	2	Nut, Hex Fiber Insert #10-24 HARDWARE
H26	2-00-00641	6	Nut, 1/4-20 Insert Fiber HARDWARE
H27	2-00-03702	6	Washer, .625 x .281 x .063 HARDWARE
H34	2-00-00208	7	Screw, 5/16-18 x .750 HHC HARDWARE
H46	2-00-00644	9	Nut, 5/16-18, Insert Fiber HARDWARE
H62	2-00-00405	3	Flat Washer, 1.063 x .531 x .094 HARDWARE
H86	2-00-03575	6	Carriage Bolt 1/4-20 x .750 HARDWARE
H87	2-00-00263	1	Set Screw, 1/4-20 x .250 HSKCP HARDWARE
H100	2-00-03062	2	Screw, #10-24 x .625 THM HARDWARE

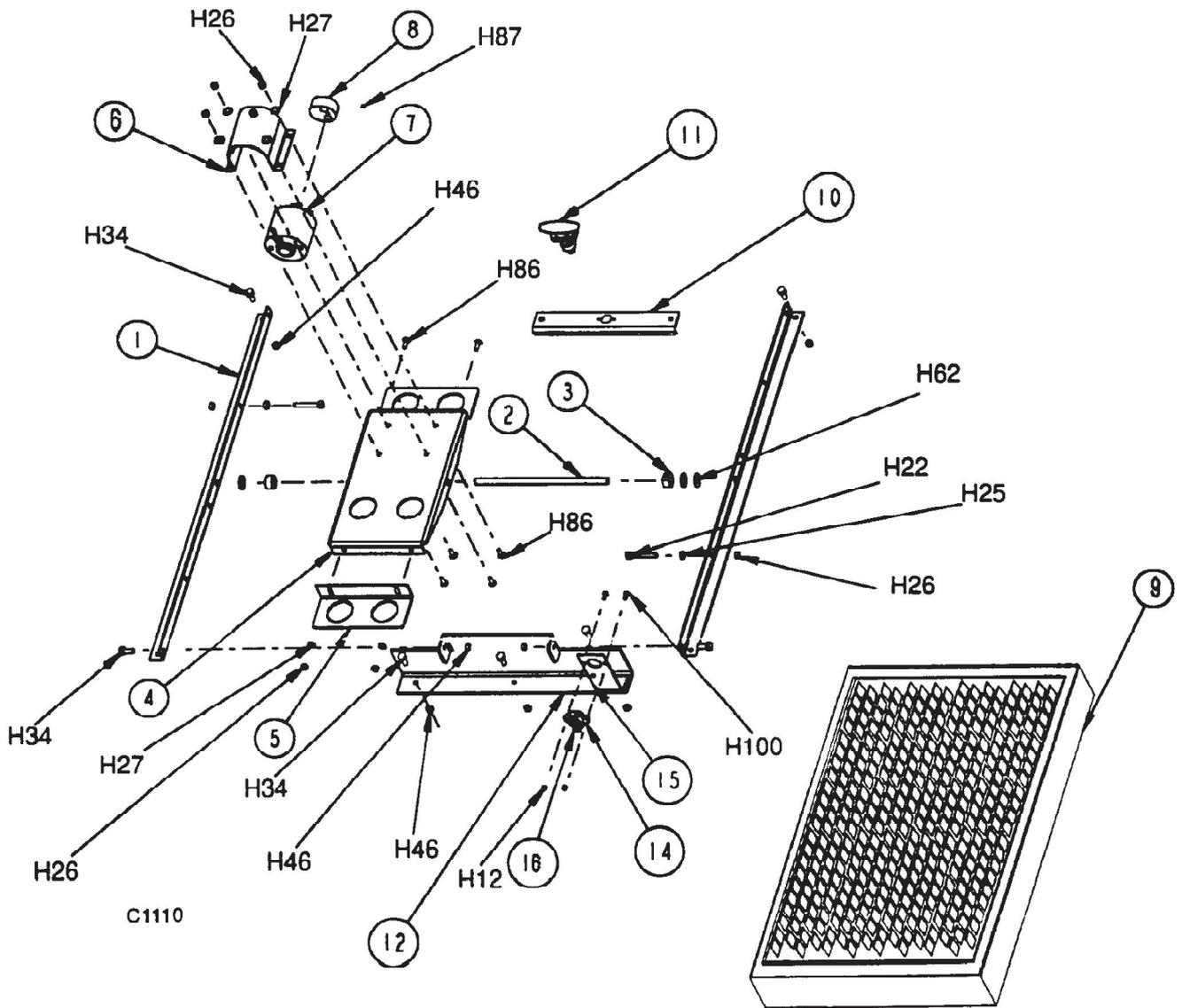

Referenznummer	Artikelnummer	Menge	Description
1	8-13-07122	2	Clamp, Filter
2	8-55-08119	1	Pin, Shaker Pivot
3	8-15-01016	2	1/2" Stop Collar
4	8-58-05273	1	Plate, Shaker
5	8-03-04302	1	Arm, Shaker
6	8-16-07181	1	Filter Shaker Motor Cover
7	0882-053-1	1	Filter Shaker Motor
8	8-89-04017	1	Brush Balancing Weights
9	8-24-04139	1	Filter
10	8-13-07121	1	Mounting Angle, Shaker
11	8-41-00053	1	Latch
12	8-08-00786	1	Mounting Angle, Shaker
13	8-90-07433	1	Wire, Hopper Shaker
14	8-82-00056	1	Switch, Thermostat
15	8-08-00803	1	Bracket, Switch
16	8-90-07432	1	Wire, Hopper Thermostat
H12	2-00-01246	2	Nut, Hex Fiber Insert #10-24
H22	2-00-02589	2	Screw, 1/4-20 x 2.000 HHC
H25	2-00-00594	2	Nut, Hex 1/4-20 x .437 x 218
H26	2-00-00641	6	Nut, 1/4-20 Insert Fiber
H27	2-00-03702	6	Washer, .625 x .281 x 063
H34	2-00-00208	7	Screw, 5/16-18 x .750 HHC
H46	2-00-00644	6	Nut, 5/16-18, Insert Fiber
H62	2-00-00405	3	Flat Washer, 1.063 x .531 x .094
H86	2-00-03575	6	Carriage Bolt, 1/4-20 x .750
H87	2-00-00263	1	Set Screw, 1/4-20 x .250 HSKCP
H100	2-00-03062	2	Screw, #10-24 x .625 THM

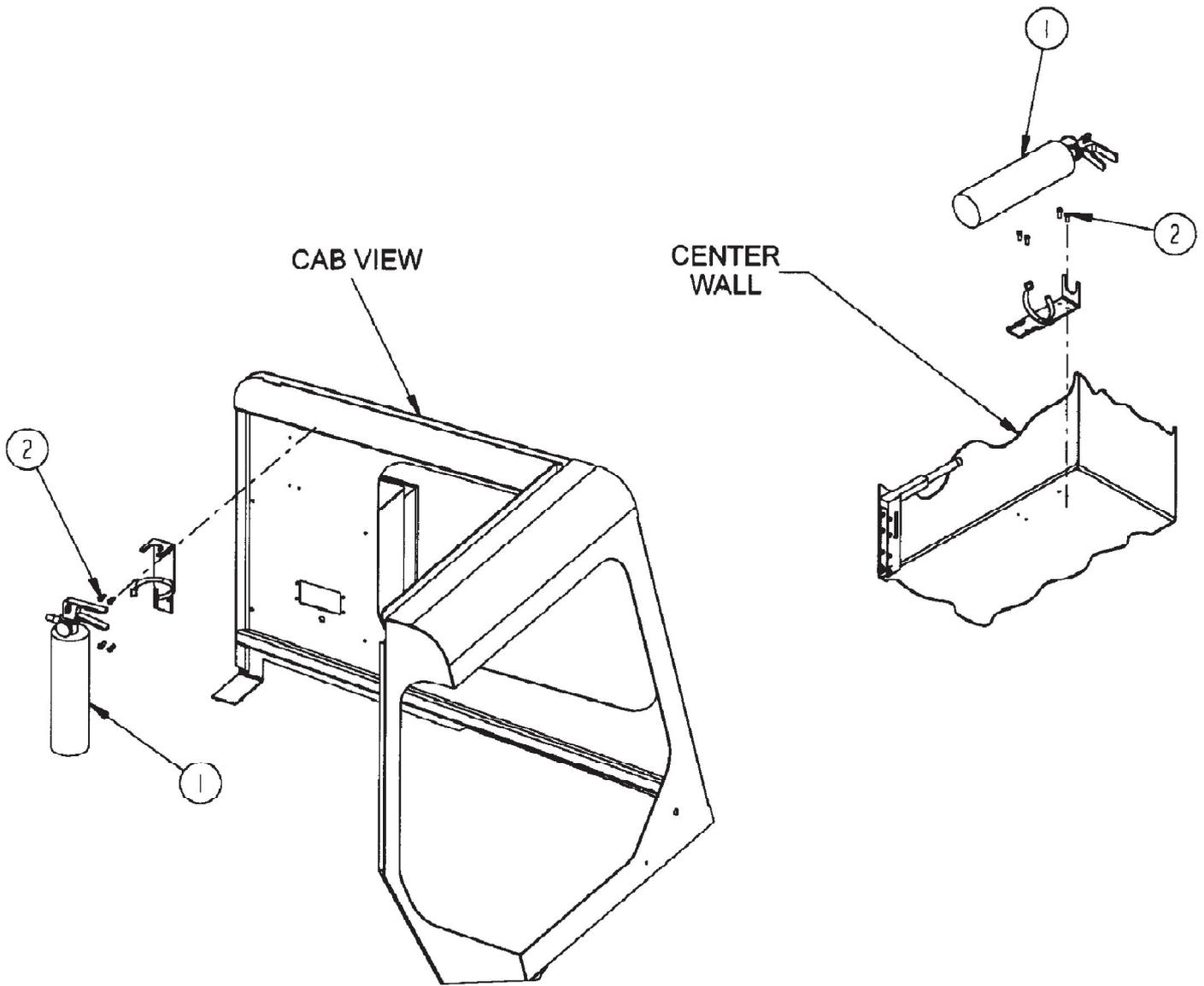

Referenznummer	Artikelnummer	Menge	Description
1	8-83-04033	1	Fire Extinguisher
2	2-95-01998	4	Screw, #1 4-10 x .750 T/F R.H.

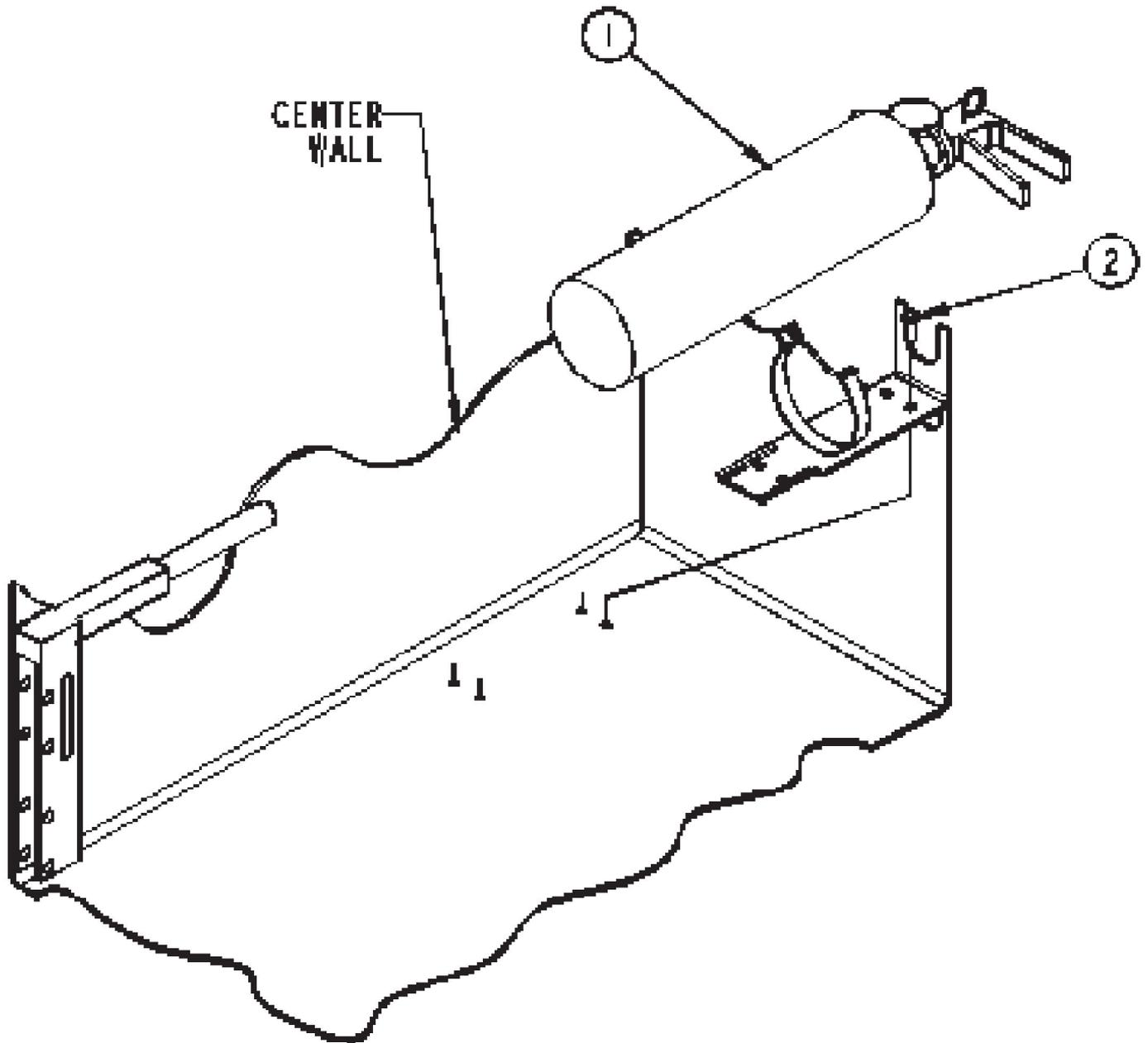

Referenznummer	Artikelnummer	Menge	Description
1	8-83-04033	1	Fire Extinguisher
2	2-95-01998	4	Screw, #14-10 x .750 T/F R.H.

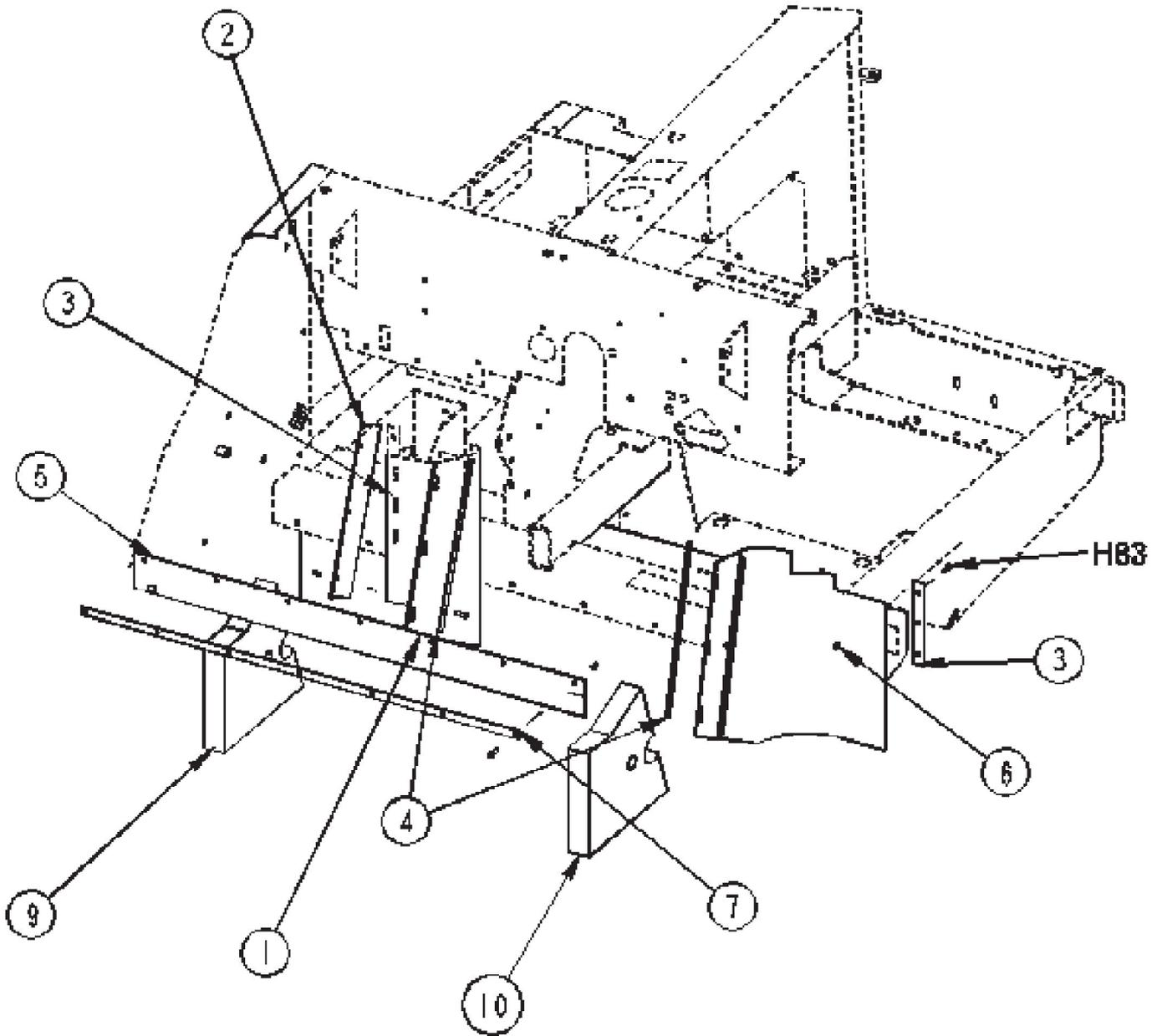

Referenznummer	Artikelnummer	Menge	Description
1	8-25-08194	2	Flap, Wheel Well
2	8-13-07113	2	Clamp, Wheel Well Flap, Front
3	8-13-07112	2	Clamp, Wheel Well Flap, Rear
4	8-13-07123	2	Clamp, Wheel Well Flap, Front
5	8-68-05078	1	Seal, Broom Door Chamber/Dump Door
6	2-00-05261	19	Threaded Insert
7	8-13-07119	1	Clamp, Dump Door Seal
9	8-68-05079	1	Seal, Wheel Well, Right
10	8-68-05080	1	Seal, Wheel Well, Left
H83	2-00-04877	19	Screw, 1/4-20 x 1.000 BHS

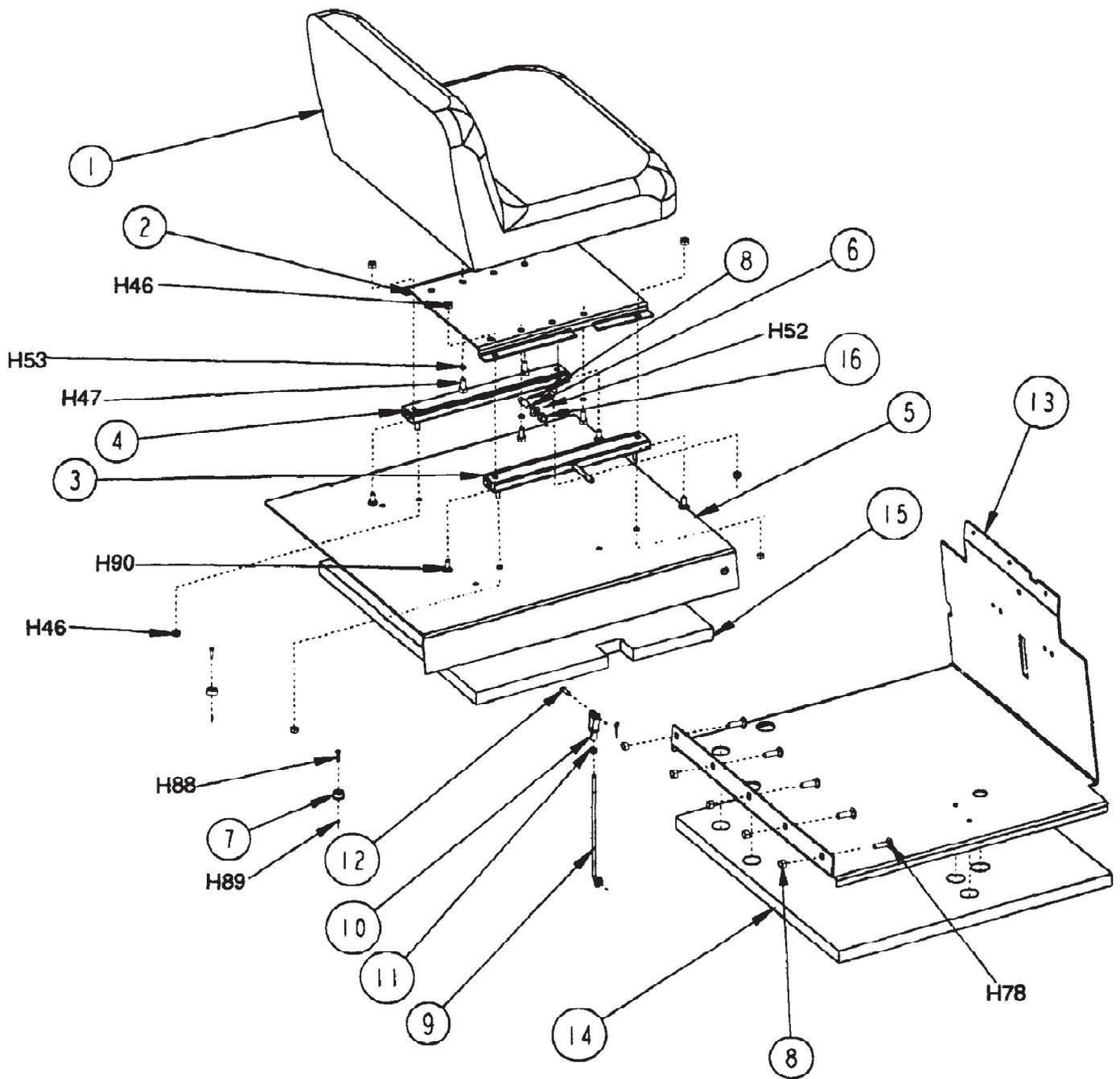

Referenznummer	Artikelnummer	Menge	Description
1	8-69-00003	1	Seat
2	8-08-00672	1	Bracket, Seat
3	8-72-05003	1	Side, Seat Adjustor
4	8-72-05002	1	Side, Seat
5	8-16-07348	1	Seat Deck
6	8-55-08121	1	Pin, Seat Deck Pivot
7	8-50-05058	2	Rubber Bumpers
8	2-95-04182	9	Stop Nut, Elastic
9	8-66-00171	1	Prop Rod
10	8-14-01006	1	Clevis
11	2-95-01999	1	Nut, Jam
12	2-00-04909	1	Yoke Pin
13	8-52-00123	1	Floor/Kick Panel
14	8-34-09016	1	Insulation, Floor
15	8-34-09019	1	Insulation, Seat Deck
16			UNKNOWN
H46	2-00-00644	8	Nut, 5/16-18, Insert Fiber
H47	2-00-00232	4	Screw, 3/8-16 x .750 HHC
H52	2-00-00402	5	Flat Washer, .750 x .390 x .094
H53	2-00-02310	4	Lock Washer, Helical Spring 3/8 Med.
H78	2-00-05187	5	Carriage Bolt, 3/8-16 x 1.250
H88	2-00-05258	2	Screw, #8-325 x .750 BHS
H89	2-00-01372	2	Nut, Fiber Insert #8-32 Steel
H90	2-00-03569	4	Carriage Bolt, 5/16-18 x .750

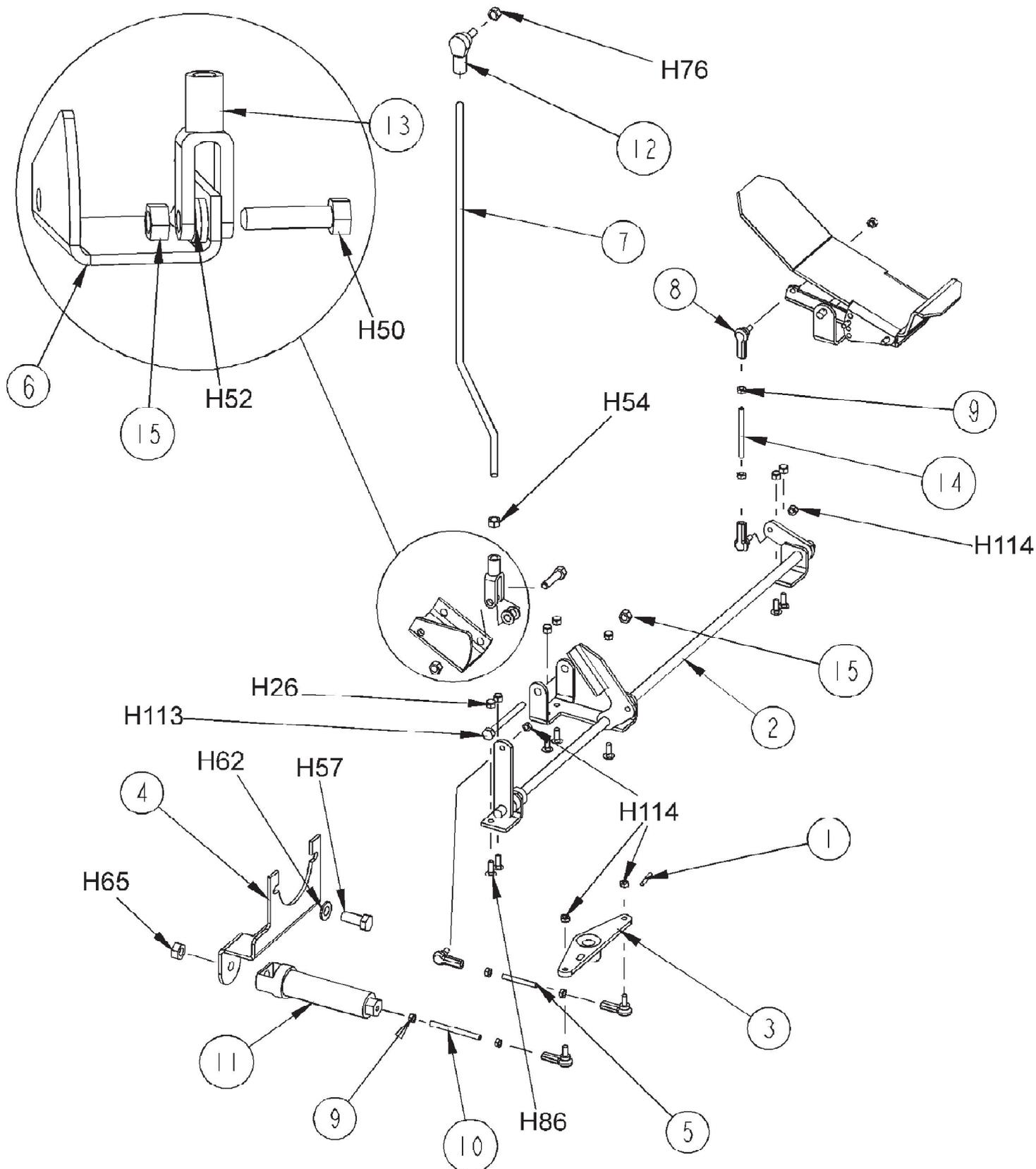

Referenznummer	Artikelnummer	Menge	Description
1	2-00-00880	1	Roll Pin
2	8-70-05294	1	Forward/Reverse Shaft
3	8-03-04300	1	Arm, Pump Control
4	8-08-00781	1	Bracket, Hydroback
5	8-66-00169	2	Rod, 1/4-28 Threaded
6	8-03-04306	1	Arm, Speed Limiter
7	8-66-00172	1	Rod, Speed Limiter
8	7-25-02050	5	Rod End
9	2-95-01999	11	Nut, Jam
10	7-66-00147	1	Rod, Threaded
11	8-16-00025	1	Centering Control
12	8-66-00173	1	Rod End
13	8-14-01001	1	Clevis
14	8-66-00179	1	Rod, Threaded, 1/4-28 x 2.50
15	2-95-04182	2	Nut, Fiber
H26	2-00-00641	7	Nut, 1/4-20 Insert Fiber
H50	2-00-00234	1	Screw, 3/8-16 x 1.500 HHC
H52	2-00-00402	2	Flat Washer, .750 x .390 x .094
H54	2-00-02360	1	Nut, 3/8-16 Hex.
H57	2-00-00240	1	Screw, 1/2-13 x 1.250 HHC
H62	2-00-00405	1	Flat Washer, 1.063 x .531 x .094
H65	2-00-04936	1	Nut, 1/2-13 Fibre Lock
H76	2-00-00632	1	Nut, Fiber Insert 3/8-24 Steel
H86	2-00-03575	7	Carriage Bolt, 1/4-20 x .750
H113	2-00-03333	1	Screw, 3/8-16 x 3.750 HHC
H114	2-00-00633	4	Nut, Fiber 1/4-28

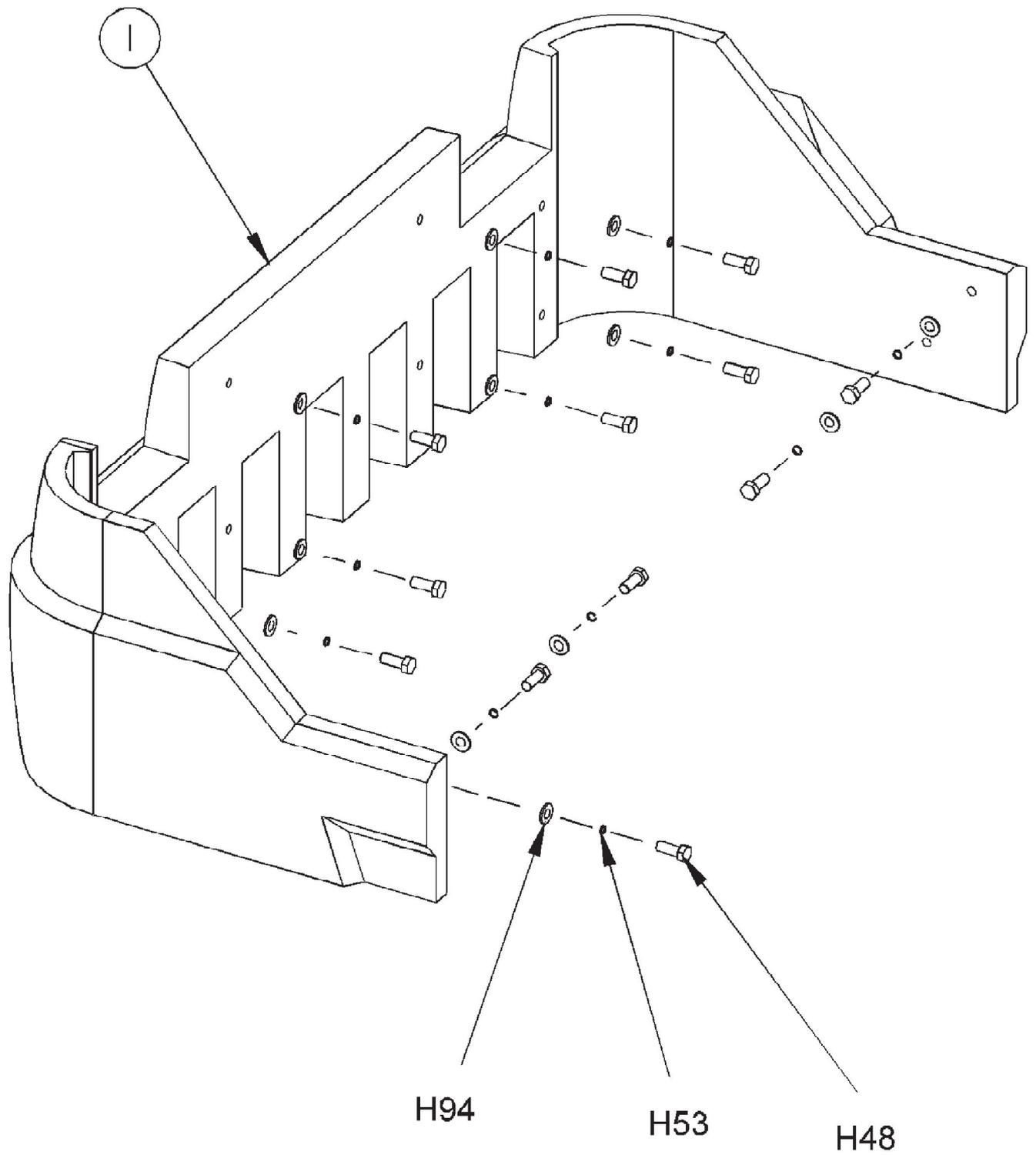

Referenznummer	Artikelnummer	Menge	Description
1	8-08-07055	1	Front Bumper
H48	2-00-00233	12	Screw, 3/8-16 x 1.000 HHC
H53	2-00-02310	12	Lock Washer, Helical Spring 3/8 Med.
H94	2-00-00410	12	Flat Washer, .875 x .375 x .060

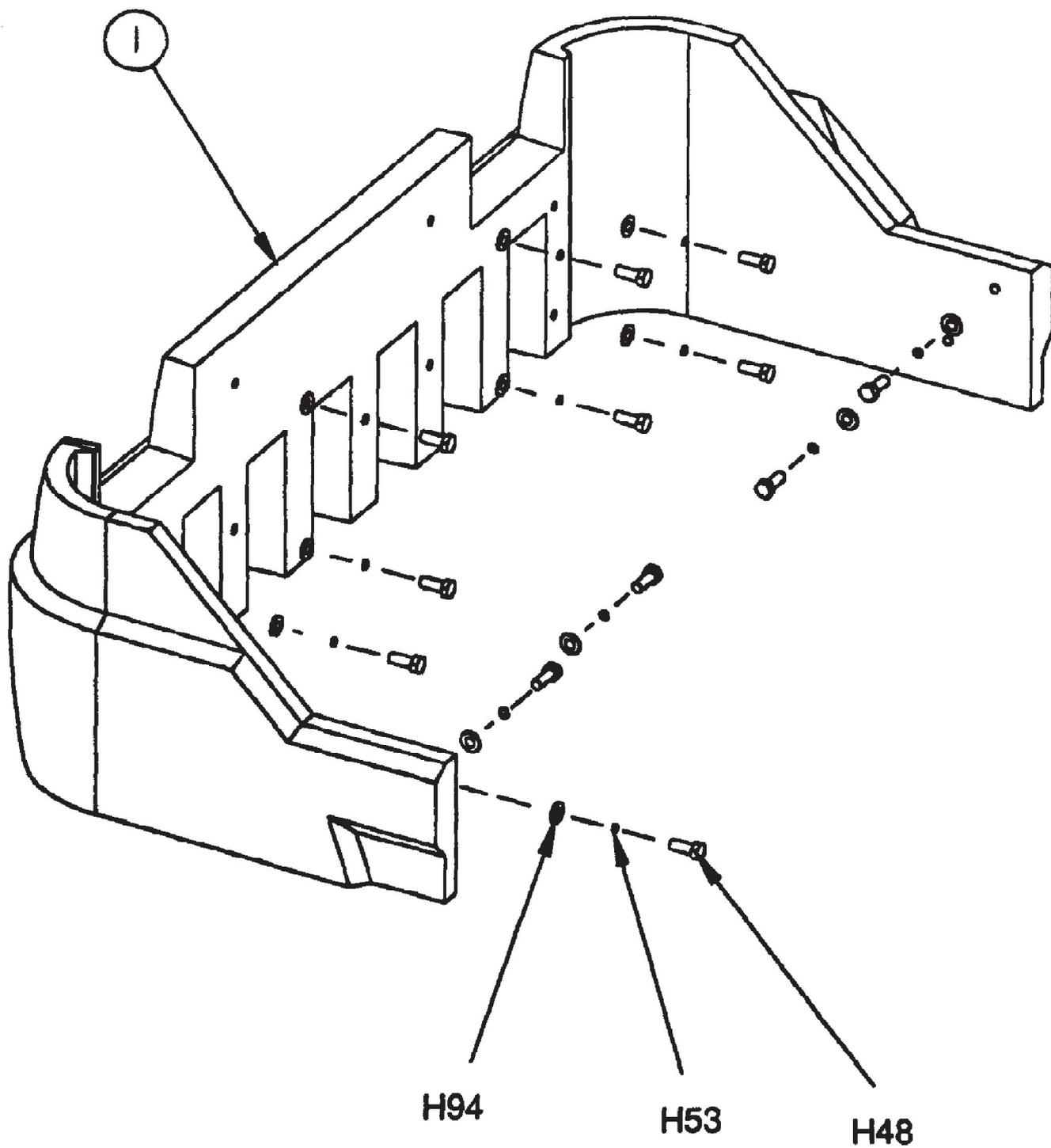

Referenznummer	Artikelnummer	Menge	Description
1	8-08-07055	1	Front Bumper
H48	2-00-00233	12	Screw, 3/8-16 x 1.000 HHC HARDWARE
H53	2-00-02310	12	Lock Washer, Helical Spring 3/8 Med. HARDWARE
H94	2-00-04851	12	Flat Washer HARDWARE

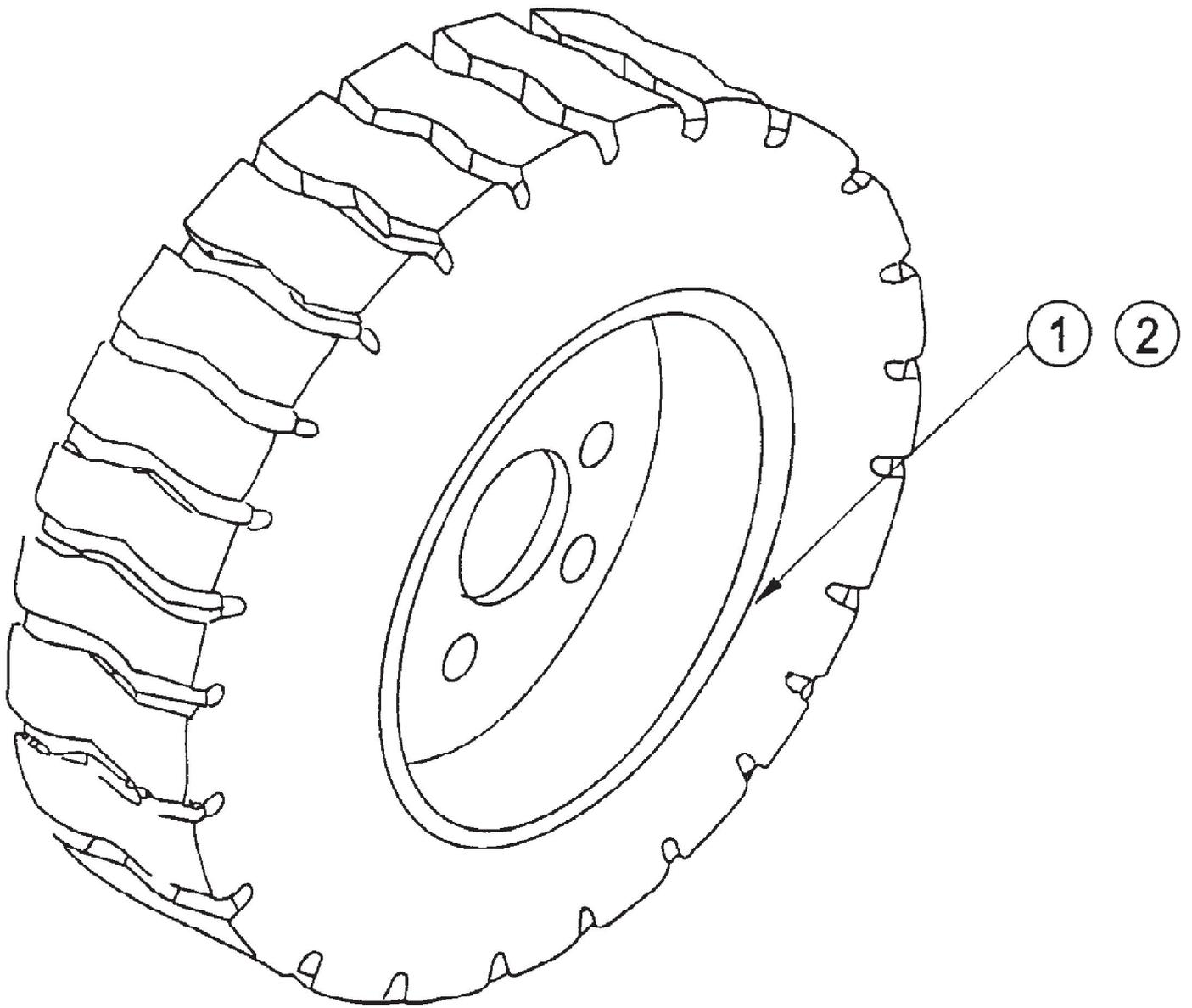

Referenznummer	Artikelnummer	Menge	Description
	0880-610-1		Front Solid Cushion Tire Option
1	8-89-08071	2	Wheel Assembly, Soft Shoe Demountable
2	8-85-06018	Ref.	Tire, Soft Shoe

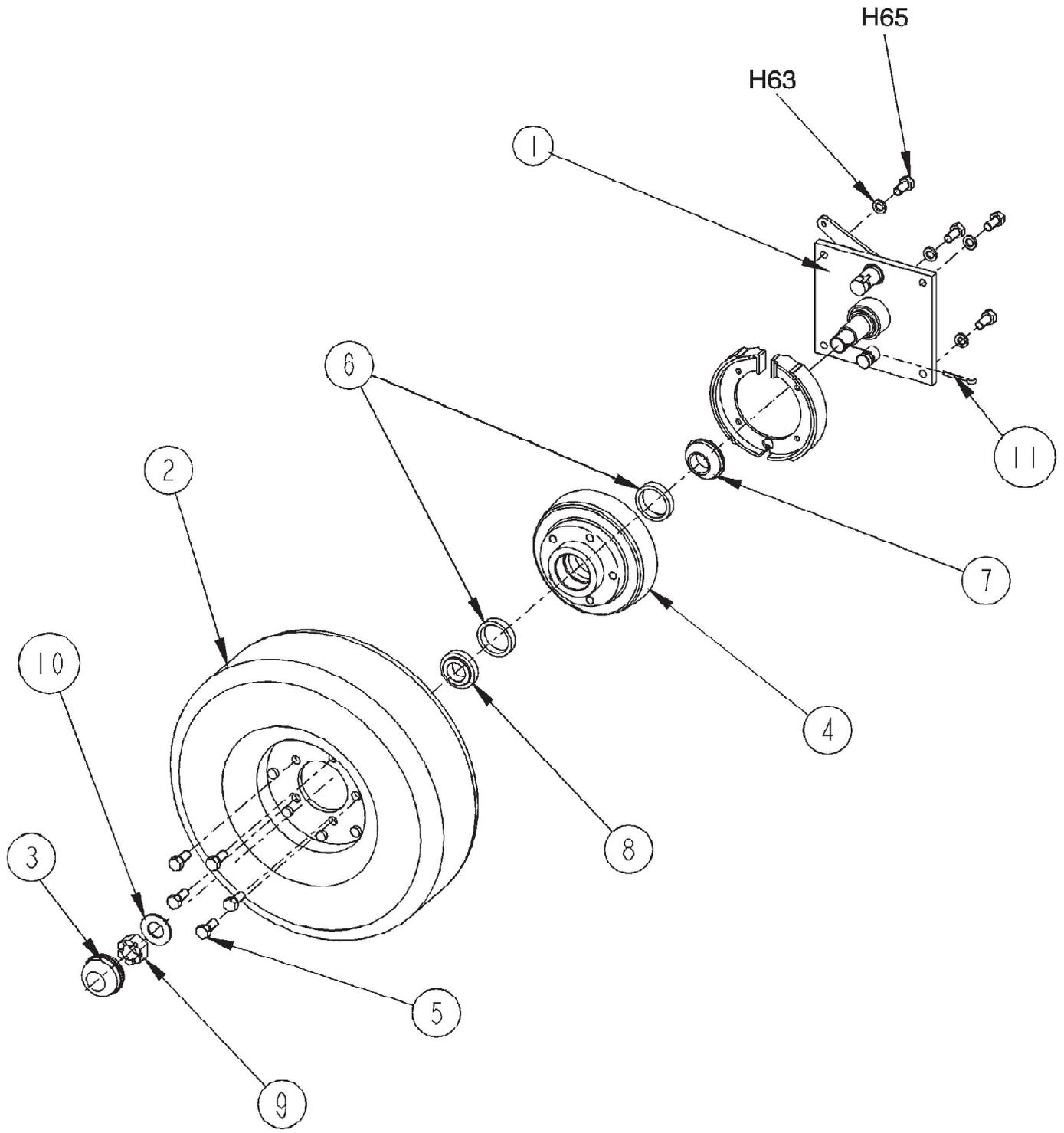

Referenznummer	Artikelnummer	Menge	Description
1	0860-571	2	Brake
	8-71-05007		Brake Shoe Service Part
2	8-89-08067	2	Wheel, Pneumatic-18.5"
	8-85-06021		Tire Service Part
	8-70-00085		Tube Service Part
	8-70-00080		Rim Service Part
3	8-11-00030	2	Grease Cap
4	8-33-09089	2	Hub and Drum
5	8-80-05035	10	Stud
6	2-00-04621	4	Bearing Cup
7	2-00-02079	2	Bearing Cone (Sealed)
8	2-00-04622	2	Bearing Cone
9	2-00-05026	2	Nut, Slotted Hex 1-14 UNF
10	2-95-01977	2	Flat Washer
11	2-00-02436	2	Cotter Pin
H63	2-00-02312	8	Lock Washer, 1/2 HS Med.
H65	2-00-04936		Nut, 1/2-13 Fibre Lock
H66	2-00-02689	8	Screw, 1/2-20 x 1.000 HHC

Referenznummer	Artikelnummer	Menge	Description
1	8-83-04029	1	Gas Tank
2	8-08-00791	1	Fuel Support Bracket
3	2-95-04182	2	Nut, Fiber Insert
4	2-00-04873	3	Clamp
5	8-87-02113	1	Fuel Line
6	8-26-04003	1	Float/Sender
7	2-00-04494	1	Fitting
8	8-08-07038	1	Bumper
9	2-00-05253	1	Clamp
10	7-11-00029	1	Cap
11	8-56-05021	1	Fitting
12	2-00-04618	1	Fitting
13	2-00-04873	1	Hose Clamp
H15	2-00-00221	7	Screw, 1/4-20 x .750 HHC
H26	2-00-00641	7	Nut, 1/4-20 Insert Fiber
H27	2-00-03702	4	Washer, .625 x .281 x .063
H78	2-00-05187	2	Carriage Bolt, 3/8-16 x 1.250
H79	2-00-01676	2	Flat Washer, 1.062 x .265 x .062

Referenznummer	Artikelnummer	Menge	Description
1	8-83-04029	1	Gas Tank
2	8-08-00791	1	Fuel Support Bracket
3	2-95-04182	2	Nut, Fiber Insert
4	2-00-04564	3	Clamp
5	8-87-02113	1	Fuel Line
6	8-26-04003	1	Float/Sender
7	2-00-04494	1	Fitting
8	8-08-07038	1	Bumper
9	2-00-05050	1	Clamp
10	7-11-00029	1	Cap
11	8-56-05021	1	Fitting
12	2-00-04618	1	Fitting
13	2-00-04873	1	Hose Clamp
H15	2-00-00221	7	Screw, 1/4-20 x .750 HHC HARDWARE
H26	2-00-00641	7	Nut, 1/4-20 Insert Fiber HARDWARE
H27	2-00-03702	4	Washer, .625 x .281 x .063 HARDWARE
H78	2-00-05187	2	Carriage Bolt, 3/8-16 x 1.250 HARDWARE
H79	2-00-01676	2	Flat Washer, 1.062 x .265 x .062 HARDWARE

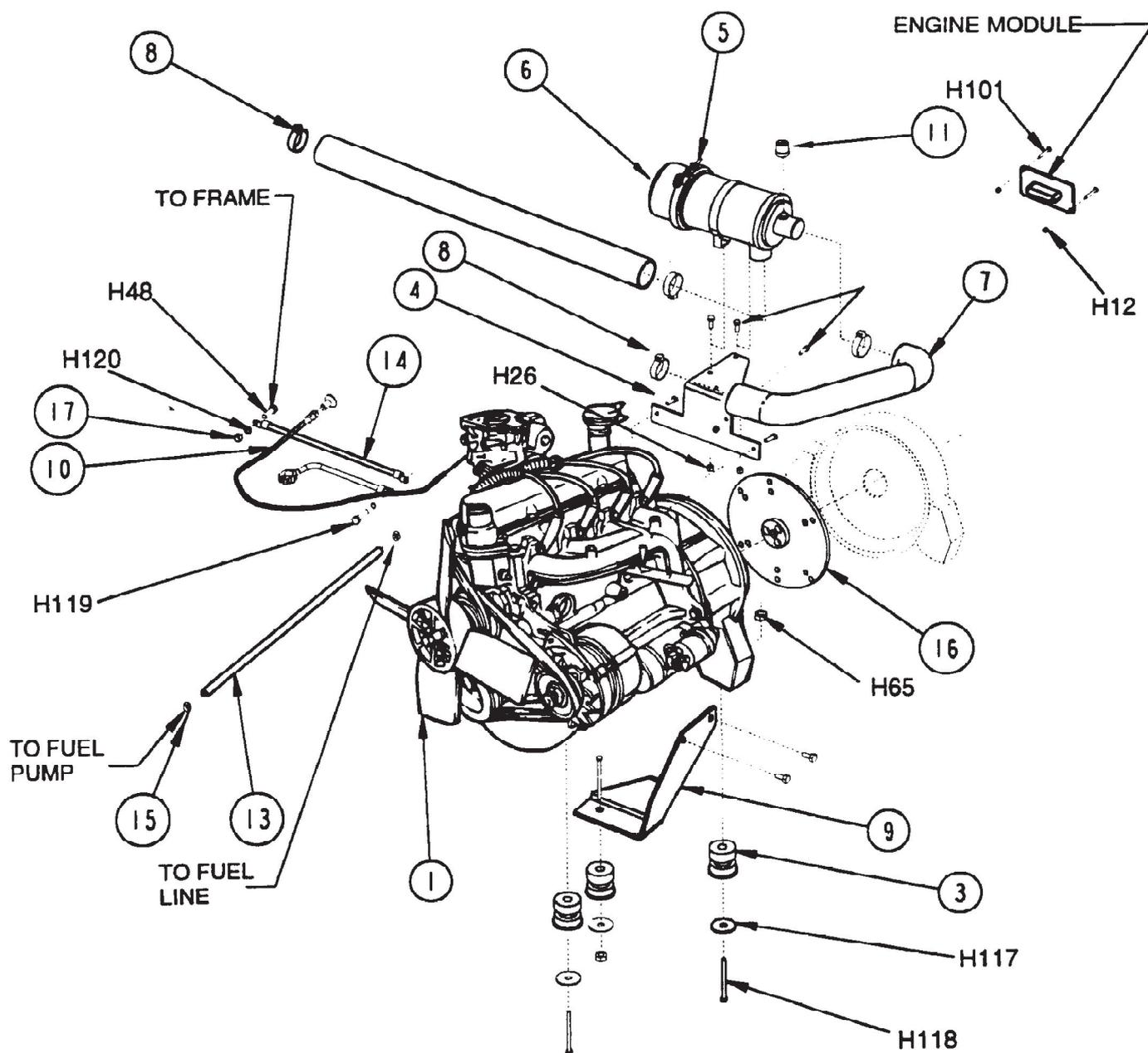

Referenznummer	Artikelnummer	Menge	Description
1	0877-052	1	411 Ford Engine
1A	0877-054	1	413 Ford Engine (XP Model)
2	2-00-05067	3	Washer
3	7-35-00017	3	Isolator Mount
4	8-08-00783	1	Air Filter Mounting Bracket
5	8-24-04093	1	Band Assembly
6	8-24-04100	1	Air Cleaner
	8-24-04106	Ref.	Air Cleaner Element (Service Part)
7	8-33-02279	1	Hose, Air Cleaner to Carburetor
8	2-00-02216	2	Clamp, Hose
9	8-08-00778	1	Engine Mounting Bracket
10	8-16-00054	1	Choke Cable
11	8-24-04101	1	Meter
12	7-33-02026	1	Hose, Air Cleaner Inlet
13	8-33-02145	1	Hose, Fuel
14	8-90-07328	1	Cable
15	2-95-04388	2	Clamp
16	8-16-05026	1	Coupling, Engine-Pump
17	2-95-04182	1	Nut, Fiber
H12	2-00-01246	2	Nut, Hex Fiber Insert #10-24 Hardware
H15	2-00-00221	3	Screw, 1/4-20 x .750 HHC Hardware
H26	2-00-00641	3	Nut, 1/4-20 Insert Fiber Hardware
H48	2-00-00233	1	Screw, 3/8-16 x 1.000 HHC Hardware
H65	2-00-04936	3	Nut, 1/2-13 Fibre Lock Hardware
H101	2-00-04897	2	Screw, #10-24 x 1.250 THM Hardware
H117	2-00-05067	3	Flat Washer, 1.750 x .531 x .100 Hardware
H118	2-00-02618	3	Screw, 1/2-13 x 3.500 HHC Hardware
H119	2-00-05005	1	Screw, M10 x 1.500 30 mm MHC Hardware
H120	2-00-03829	1	Lock Washer, 3/8 Bolt Hardware
	8-60-05024		Water Pump W/Gasket Ford Engine Service Parts
	8-84-08001		Thermostat Ford Engine Service Parts
	8-84-00167		Thermostat Gasket Ford Engine Service Parts
	8-70-00066		Fuel Pump W/Gasket Ford Engine Service Parts
	8-03-03005		Alternator W/Pully Ford Engine Service Parts
	2-00-05248		Alternator Belt Ford Engine Service Parts
	0869-085		Carburetor Ford Engine Service Parts
	8-29-00217		Carburetor Gasket Ford Engine Service Parts
	0875-120		Starter Ford Engine Service Parts
	8-14-07011		Coil Ford Engine Service Parts
	8-24-04099		Oil Filter Ford Engine Service Parts
	8-24-04138		Fuel Filter Ford Engine Service Parts
	8-70-00072		Spark Plug Wire Set Ford Engine Service Parts
	8-75-03007		Spark Plug Ford Engine Service Parts

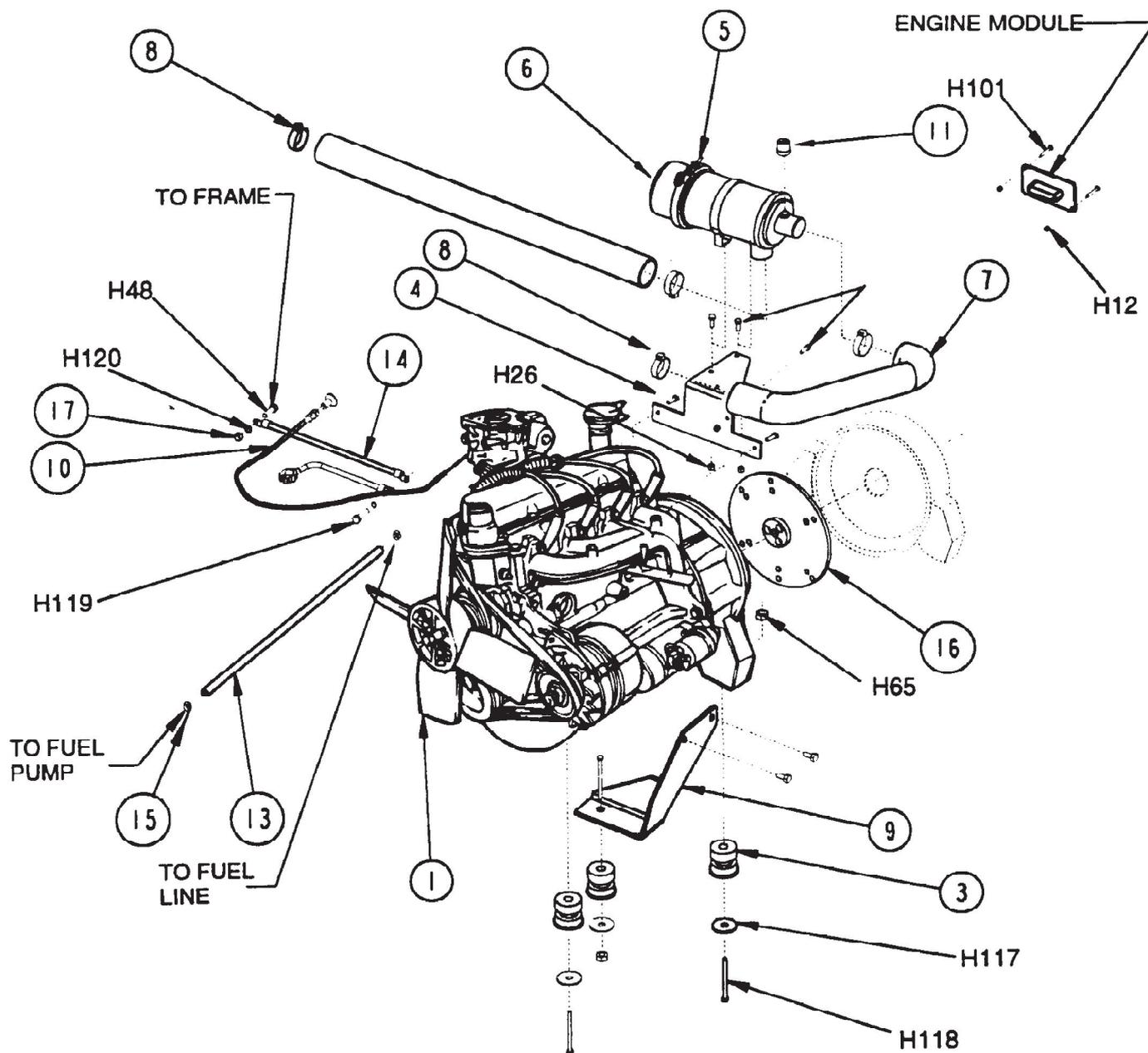

Referenznummer	Artikelnummer	Menge	Description
1	0877-052	1	411 Ford Engine
1	0877-054	1	413 Ford Engine (XP Model)
2	2-00-05067	3	Washer
3	7-35-00017	3	Isolator Mount
4	8-08-00783	1	Air Filter Mounting Bracket
5	8-24-04093	1	Band Assembly
6	8-24-04100	1	Air Cleaner
	8-24-04106	Ref.	Air Cleaner Element (Service Part)
7	8-33-02279	1	Hose, Air Cleaner to Carburetor
8	2-00-02216	2	Clamp, Hose
9	8-08-00778	1	Engine Mounting Bracket
10	8-16-00054	1	Choke Cable
11	8-24-04101	1	Meter
12	7-33-02026	1	Hose, Air Cleaner Inlet
13	8-33-02145	1	Hose, Fuel
14	8-90-07328	1	Cable
15	2-95-04388	2	Clamp
16	8-16-05026	1	Coupling, Engine-Pump
17	2-95-04182	1	Nut, Fiber
H12	2-00-01246	2	Nut, Hex Fiber Insert #10-24
H15	2-00-00221	3	Screw, 1/4-20 x .750 HHC
H26	2-00-00641	3	Nut, 1/4-20 Insert Fiber
H48	2-00-00233	1	Screw, 3/8-16 x 1.000 HHC
H65	2-00-04936	3	Nut, 1/2-13 Fibre Lock
H101	2-00-04897	2	Screw, #10-24 x 1.250 THM
H117	2-00-05067	3	Flat Washer, 1.750 x .531 x .100
H118	2-00-02618	3	Screw, 1/2-13 x 3.500 HHC
H119	2-00-05005	1	Screw, M10 x 1.500 30 mm MHHC
H120	2-00-03829	1	Lock Washer, 3/8 Bolt
	8-60-05024		Water Pump w/Gasket
	8-84-08001		Thermostat
	8-84-00167		Thermostat Gasket
	8-70-00066		Fuel Pump w/Gasket
	8-03-03005		Alternator w/Pully
	2-00-05248		Alternator Belt
	0869-072		Carburetor
	8-29-00217		Carburetor Gasket
	0875-120		Starter
	8-14-07011		Coil
	8-24-04099		Oil Filter
	8-24-04138		Fuel Filter
	8-70-00072		Spark Plug Wire Set
	8-75-03007		Spark Plug

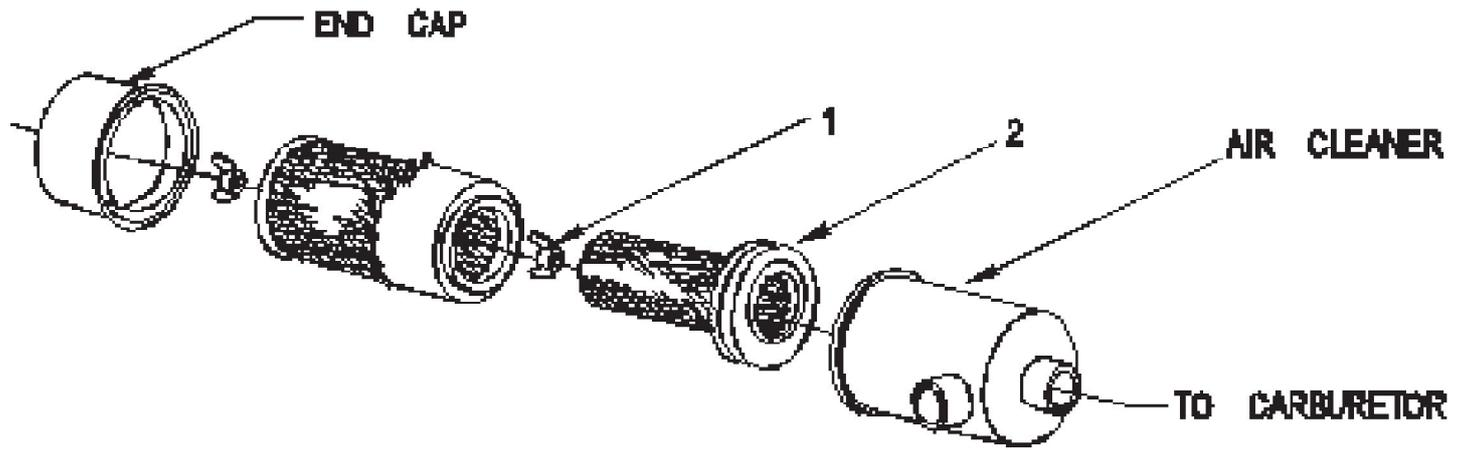

Referenznummer	Artikelnummer	Menge	Description
	0880-369		Heavy Duty Air Cleaner Option
1	8-23-03064	1	Wing Nut Assembly
2	8-24-04111	1	Filter Element

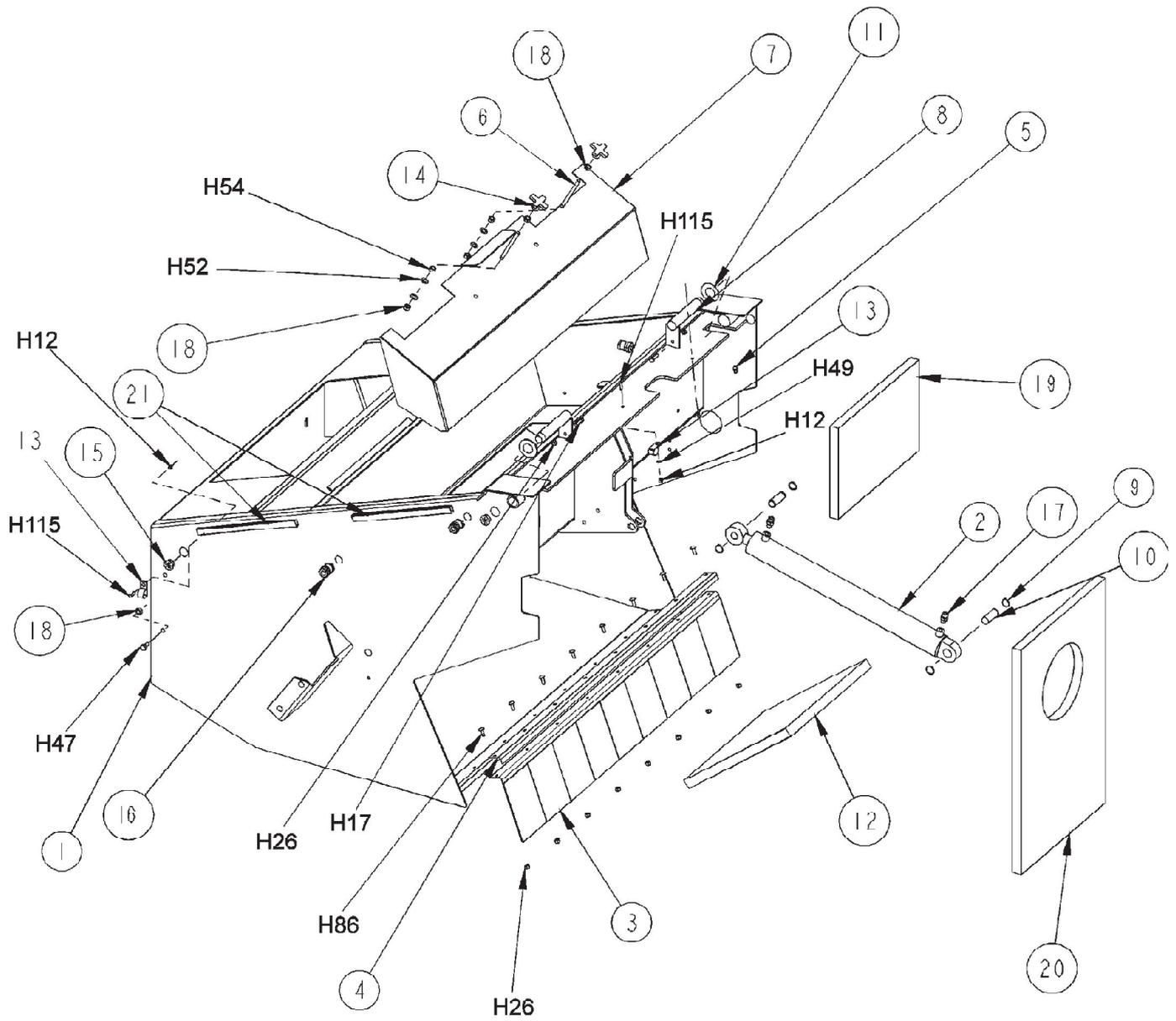

Referenznummer	Artikelnummer	Menge	Description
1	8-32-06102	1	Hopper
2	7-17-05014	1	Lift Cylinder
	0880-449		Lift Cylinder Seal Kit (Service Part)
3	8-25-08202	1	Hopper Flap
4	8-13-07117	1	Clamp, Hopper Flap
5	2-00-00566	2	Grease Zerk
6	8-80-05039	2	Stud
7	8-16-07350	1	Cover, Hopper Inlet
8	8-55-08118	2	Pin, Hopper Pivot
9	2-00-00540	4	Retaining Ring, .750 Ext.
10	8-55-08123	2	Pin, 3/4 Dia.
11	2-95-01977	3	Washer
12	8-34-09024	1	Insulation
13	2-00-04210	3	Clamp
14	55525A	2	Knob
15	8-09-01082	3	Bushing, Star
16	8-09-01083	3	Bushing, Loc-Tite
17	2-00-04895	2	Fitting
18	2-95-04182	2	Nut, Fiber
19	8-34-09023	1	Insulation
20	8-34-09022	1	Insulation
21	8-20-06036	2	Duct Wire
H9	2-00-00426	1	Flat Washer, .500 x .219 x .063
H12	2-00-01246	3	Nut, Hex Fiber Insert #10-24
H17	2-00-00205	2	Screw, 1/4-20 x 1.000 HHC
H26	2-00-00641	10	Nut, 1/4-20 Insert Fiber
H47	2-00-00232	1	Screw, 3/8-16 x .750 HHC
H49			UNKNOWN
H52	2-00-00402	4	Flat Washer, .750 x .390 x .094
H54	2-00-02360	2	Nut, 3/8-16 Hex.
H86	2-00-03575	8	Carriage Bolt, 1/4-20 x .750
H115	2-00-03063	3	Screw, #10-24 x .750 THM

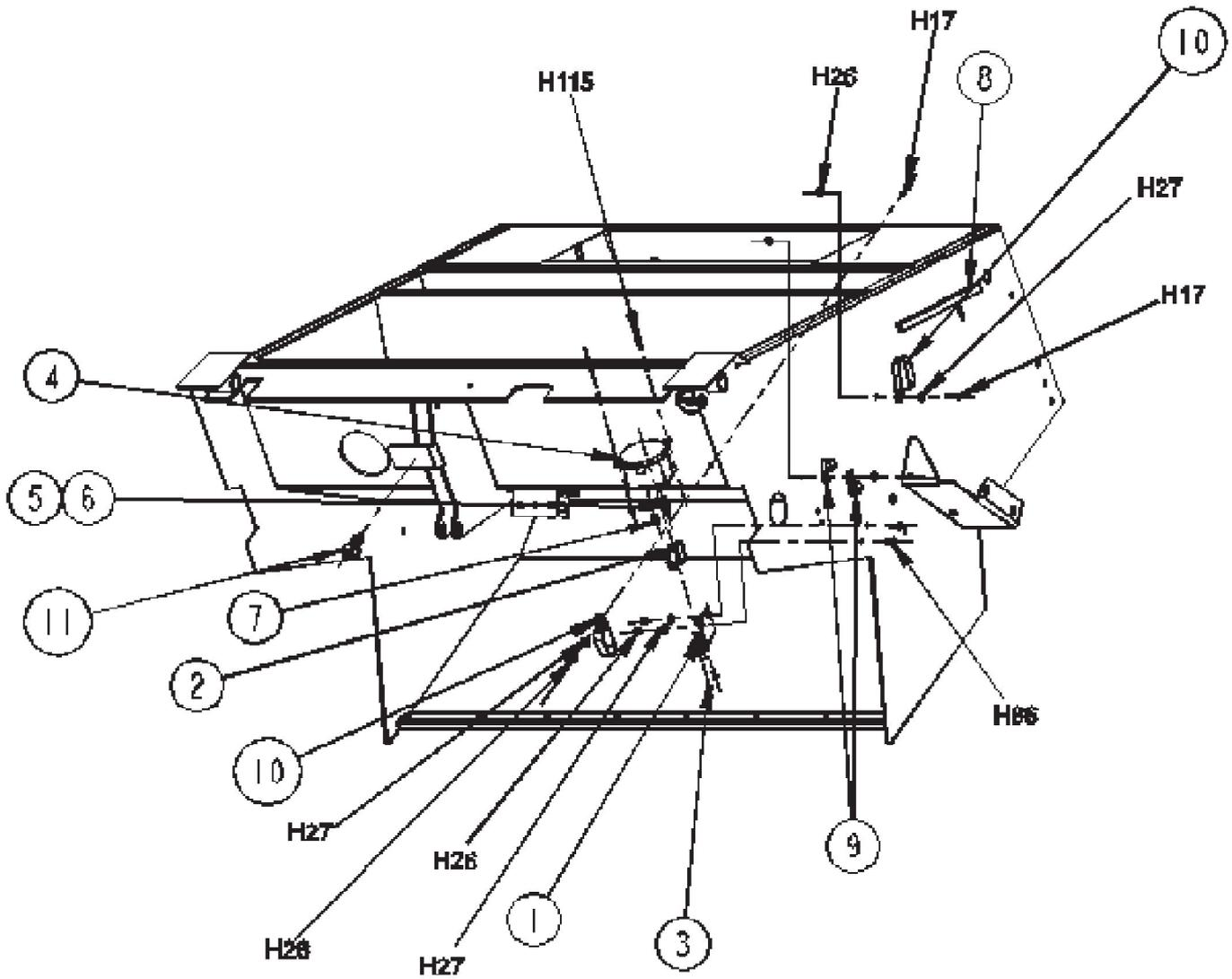

Referenznummer	Artikelnummer	Menge	Description
1	8-08-00797	1	Bracket, Swing Mounting
2	7-82-00037	1	Switch, Door Indicator
3	2-00-04274	2	Rivet
4	8-63-05014	1	Clogged Filter Switch
5	7-87-02155	1	Hose
6	2-00-04518	1	Fitting, 1/8 NPT-1/4 Tube
7	8-24-04075	1	Filter Plug
8	8-20-06036	1	Duct Wire
9	2-00-04564	2	Clamp
10	2-00-05253	2	Clamp
11	8-82-00050	1	Switch, Hopper
H17	2-00-00205	3	Screw, 1/4-20 x 1.000 HHC
H26	2-00-00641	5	Nut, 1/4-20 Insert Fiber
H27	2-00-03702	5	Washer, .625 x .281 x .063
H86	2-00-03575	2	Carriage Bolt, 1/4-20 x .750
H115	2-00-03063	2	Screw, #10-24 x .750 THM

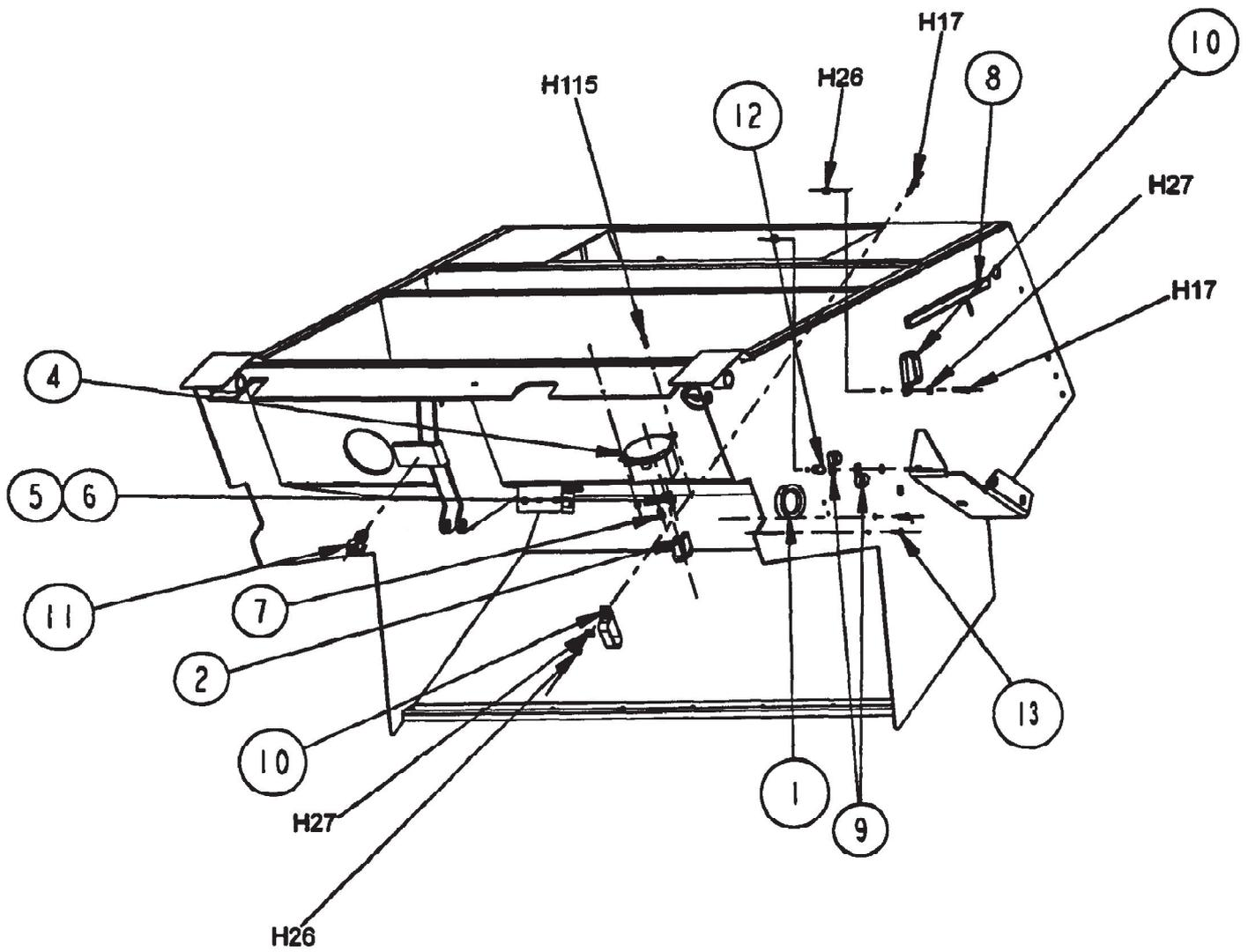

Referenznummer	Artikelnummer	Menge	Description
1	7-21-04022	1	Edging
2	8-82-00058	1	Switch, Door Indicator
4	8-63-05014	1	Clogged Filter Switch
5	7-87-02155	1	Hose
6	2-00-04518	1	Fitting, 1/8 NPT - 1/4 Tube
7	8-24-04075	1	Filter Plug
8	8-20-06036	1	Duct Wire
9	2-00-04564	2	Clamp
10	2-00-05253	2	Clamp
11	8-82-00050	1	Switch, Hopper
12	2-00-05261	1	Threaded Insert
13	2-00-00092	2	Carriage Bolt
H17	2-00-00205	2	Screw, 1/4-20 x 1.000 HHC HARDWARE
H26	2-00-00641	2	Nut, 1/4-20 Insert Fiber HARDWARE
H27	2-00-03702	3	Washer, .625 x .281 x .063 HARDWARE
H115	2-00-03063	2	Screw, #10-24 x .750 THM HARDWARE

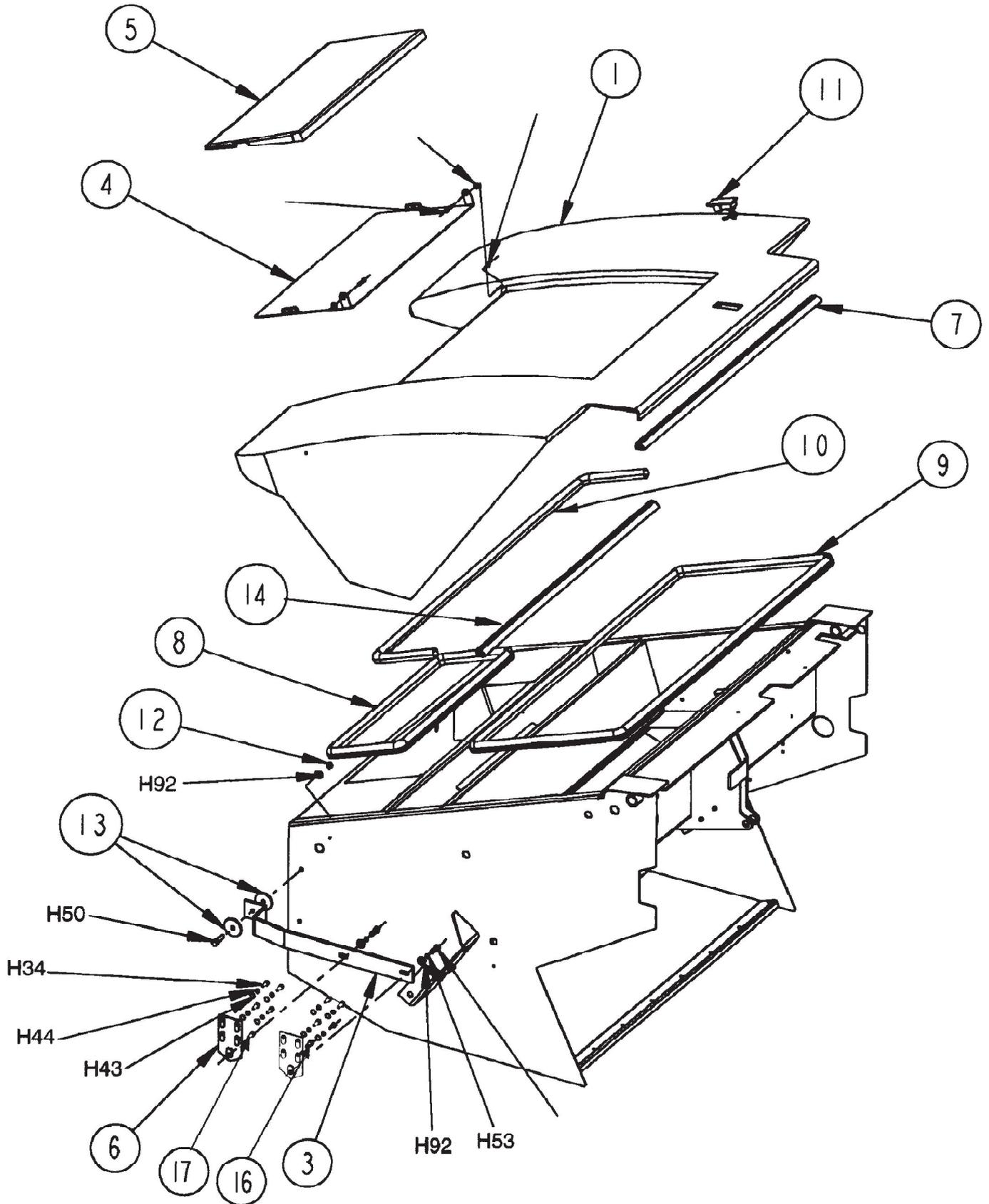

Referenznummer	Artikelnummer	Menge	Description
1	8-16-07351	1	Cover Assembly
3	8-03-04305	2	Arm
4	8-19-08062-1	1	Access Door, Inner Panel
5	8-19-08063-1	1	Access Door, Outer Panel
6	8-58-05274	4	Plate, Hopper Cover Mounting
7	8-29-00238	1	Gasket
8	8-29-00239-1	1	Gasket
9	8-29-00240	1	Gasket
10	8-29-00241	1	Gasket
11	8-41-00040	1	Latch
12	2-95-04182	2	Nut, Fiber
13	2-95-04689	6	Flat Washer
14	8-29-00243	1	Gasket, Hopper Cover
15	8-75-01214	A/R	Spacer
16	2-00-05330	16	Threaded Insert (5/16-18)
17	2-00-05347	4	Threaded Insert (3/8-16)
H16	2-00-03051	2	Screw, 1/4-20 x .750 HSHC Hardware
H25	2-00-00594	2	Nut, Hex 1/4-20 x .437 x .218 Hardware
H27	2-00-03702	2	Washer, .625 x .281 x .063 Hardware
H34	2-00-00208	16	Screw, 5/16-18 x .750 HHC Hardware
H43	2-00-00409	6	Flat Washer, .687 x .344 x .0621 Hardware
H44	2-00-00530	16	Lock Washer, 5/16 HS Med. Hardware
H48	2-00-00233	4	Screw, 3/8-16 x 1.000 HHC Hardware
H50	2-00-00234	2	Screw, 3/8-16 x 1.500 HHC Hardware
H53	2-00-02310	4	Lock Washer, Helical Spring 3/8 Med. Hardware
H92	2-00-04801	6	Flat Washer, .875 x .375 x .125 Hardware
H186	2-00-03041	2	Screw, 1/4 x 1.250 HSC-SS Hardware

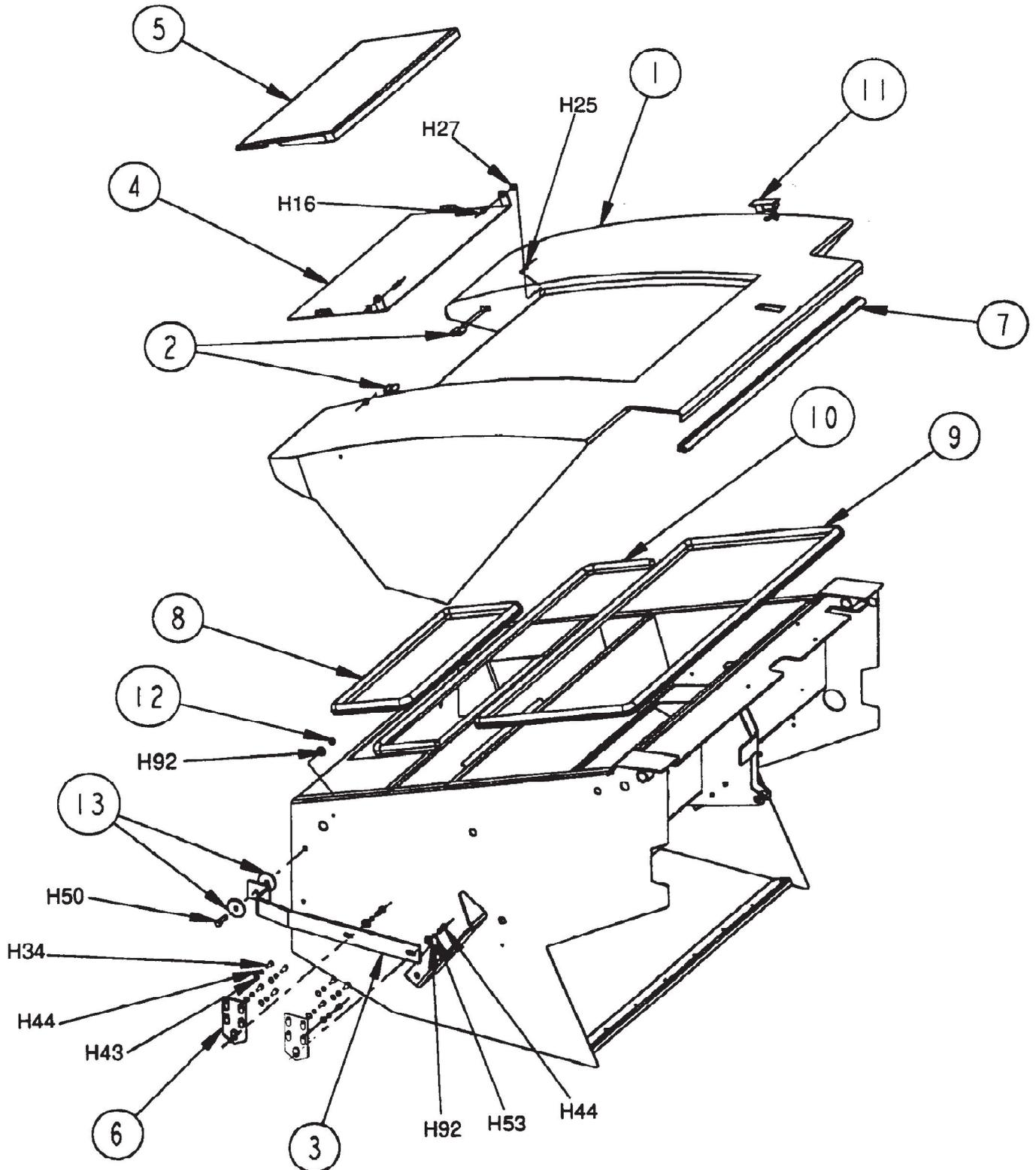

Referenznummer	Artikelnummer	Menge	Description
1	8-16-07351	1	Cover Assembly
2	8-41-00054	4	Catch
3	8-03-04305	2	Arm
4	8-19-08062	1	Access Door, Inner Panel
5	8-19-08063	1	Access Door, Outer Panel
6	8-58-05274	4	Plate, Hopper Cover Mounting
7	8-29-00238	1	Gasket
8	8-29-00239	1	Gasket
9	8-29-00240	1	Gasket
10	8-29-00241	1	Gasket
11	8-41-00040	1	Latch
12	2-95-04182	2	Nut, Fiber
13	2-95-04689	4	Flat Washer
H16	2-00-03051	2	Screw, 1/4-20 x .750 HSHC
H25	2-00-00594	2	Nut, Hex 1/4-20 x .437 x .218
H27	2-00-03702	2	Washer, .625 x .281 x .063
H34	2-00-00208	16	Screw, 5/16-18 x .750 HHC
H43	2-00-00409	6	Flat Washer, .687 x .344 x .0621
H44	2-00-00530	16	Lock Washer, 5/16 HS Med.
H48	2-00-00233	4	Screw, 3/8-16 x 1.000 HHC
H50	2-00-00234	2	Screw, 3/8-16 x 1.500 HHC
H53	2-00-02310	4	Lock Washer, Helical Spring 3/8 Med.
H92	2-00-04801	6	Flat Washer, .875 x .375 x .125

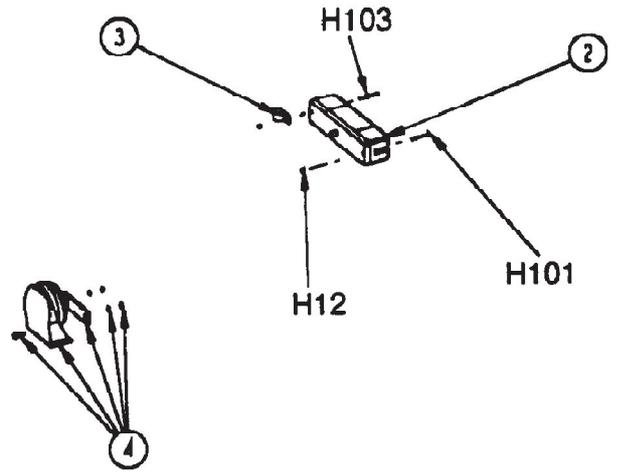
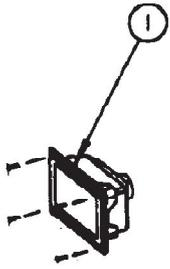

Referenznummer	Artikelnummer	Menge	Description
1	8-40-05045	2	Head Light
	8-40-05050		Head Light Sealed Beam (Service Part)
2	8-40-05044	1	Tail Light
	2-00-05291		Bulb, Tail Light (Service Part)
	8-41-03010		Lens, Tail Light, Center (Service Part)
	8-41-03011		Lens, Tail Light, Outer (Service Part)
3	2-00-04210	1	Clamp
4	8-32-09013	1	Horn
H12	2-00-01246	2	Nut, Hex Fiber Insert #10-24
H101	2-00-04897	1	Screw, #10-24 x 1.250 THM
H102	2-00-04795	8	Screw, #10-24 x .750 BHS
H103	2-00-00089	1	Screw, #10-24 x 1.500 RHM

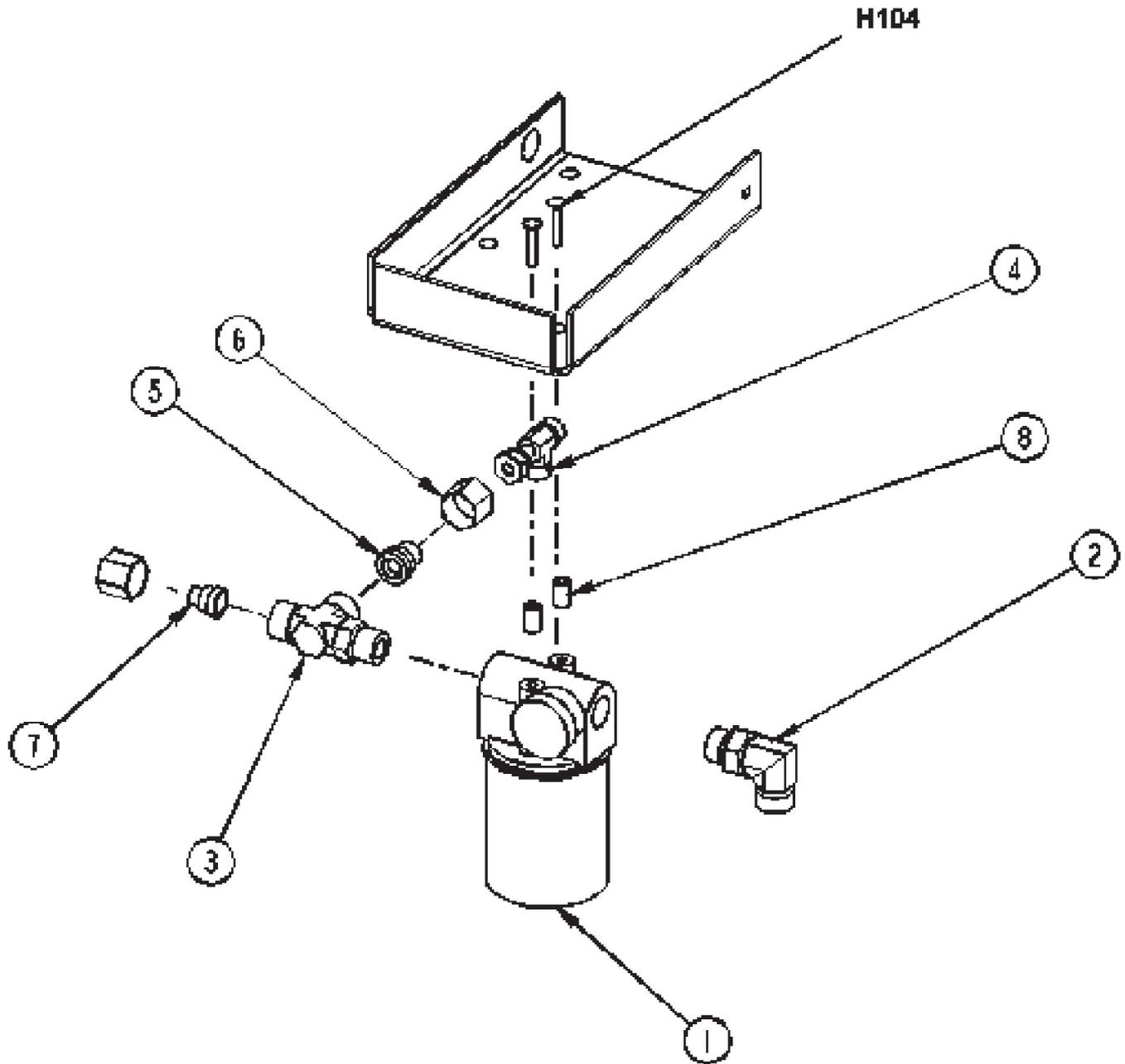

Referenznummer	Artikelnummer	Menge	Description
1	8-24-04116	1	Hydraulic Filter
	8-24-04118		Filter Element Service Part
	2-60-02280		Pressure Gauge Service Part
2	2-00-04972	1	90° Elbow
3	2-00-05269	1	Run Tee
4	2-00-04928	1	Run Tee
5	2-00-05271	1	Reducer
6	2-00-05270	1	Nut for Reducer
7	2-00-05282	1	Reducer
8	8-75-01199	2	Spacer
H104	2-00-03541	2	Screw, 1/4-20 x 1.500 FHSC

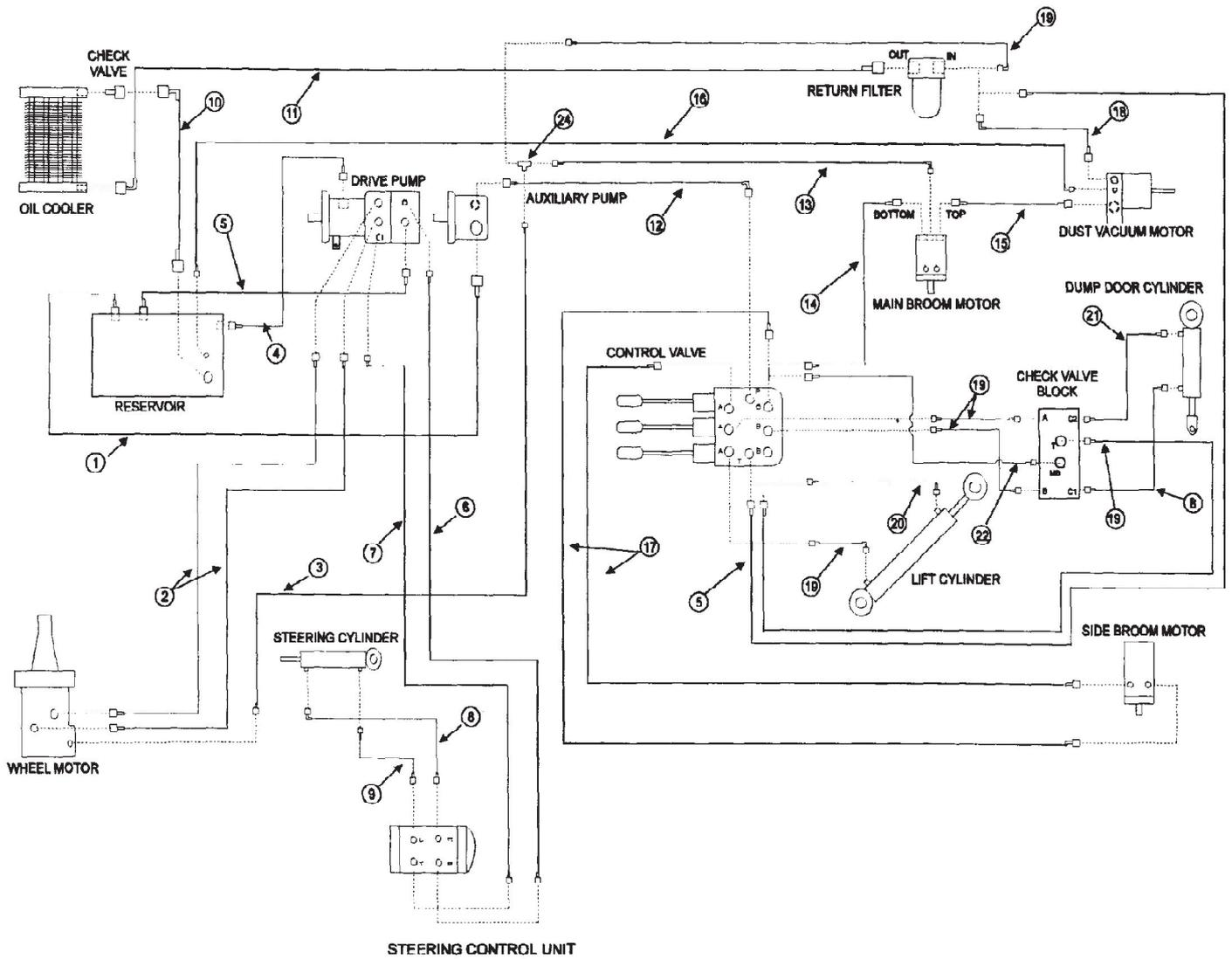

Referenznummer	Artikelnummer	Menge	Description
1	8-33-02343	1	Hose, #12 x 45.0"-0-45-ORS-1WB
2	8-33-02344	2	Hose, #8 x 55.0" -0-0-ORS-2WB
3	8-33-02173	1	Hose, #4 x 80.0" -0-0-ORS-1WB
4	8-33-02214	1	Hose, #8 x 29.0" -0-0-ORS-1WB
5	8-33-02326	2	Hose, #8 x 34.5" -0-0-ORS-1WB
6	8-33-02333	1	Hose, #6 x 46.0" -0-0-ORS-1WB
7	8-33-02334	1	Hose, #6 x 55.0" -0-0-ORS-1WB
8	7-33-02191	2	Hose, #4 x 42.0" -0-90-ORS-1WB
9	8-33-02217	1	Hose, #4 x 32.0" -0-0-ORS-1WB
10	8-33-02322	1	Hose, #12 x 47.0" -0-90-ORS-1WB
11	8-33-02321	1	Hose, #12 x 58.0" -0-90-ORS-1WB
12	8-33-02323	1	Hose, #8 x 55.0" -0-90-ORS-1WB
13	8-33-02329	1	Hose, #4 x 30.0" -0-90-ORS-1WB
14	8-33-02324	1	Hose, #8 x 72.0" -0-0-ORS-1WB
15	8-33-02325	1	Hose, #8 x 65.0" -0-0-ORS-1WB
16	8-33-02328	1	Hose, #4 x 78.5" -0-90-ORS-1WB
17	8-33-02327	2	Hose, #8 x 94.0" -0-0-ORS-1WB
18	7-33-02206	1	Hose, #8 x 14.25" -0-90-ORS-1WB
19	7-33-02189	5	Hose, #4 x 26.0" 0-90-ORS-1WB
20	8-33-02175	1	Hose, #4 x 21.0" -0-0-ORS-1WB
21	7-33-02193	1	Hose, #4 x 64.0" - 0-90-ORS-1WB
22	8-33-02176	1	Hose, #4 x 22.0" - 0-90-ORS-1WB
24	2-00-04930	1	Fitting, Union Tee, #4

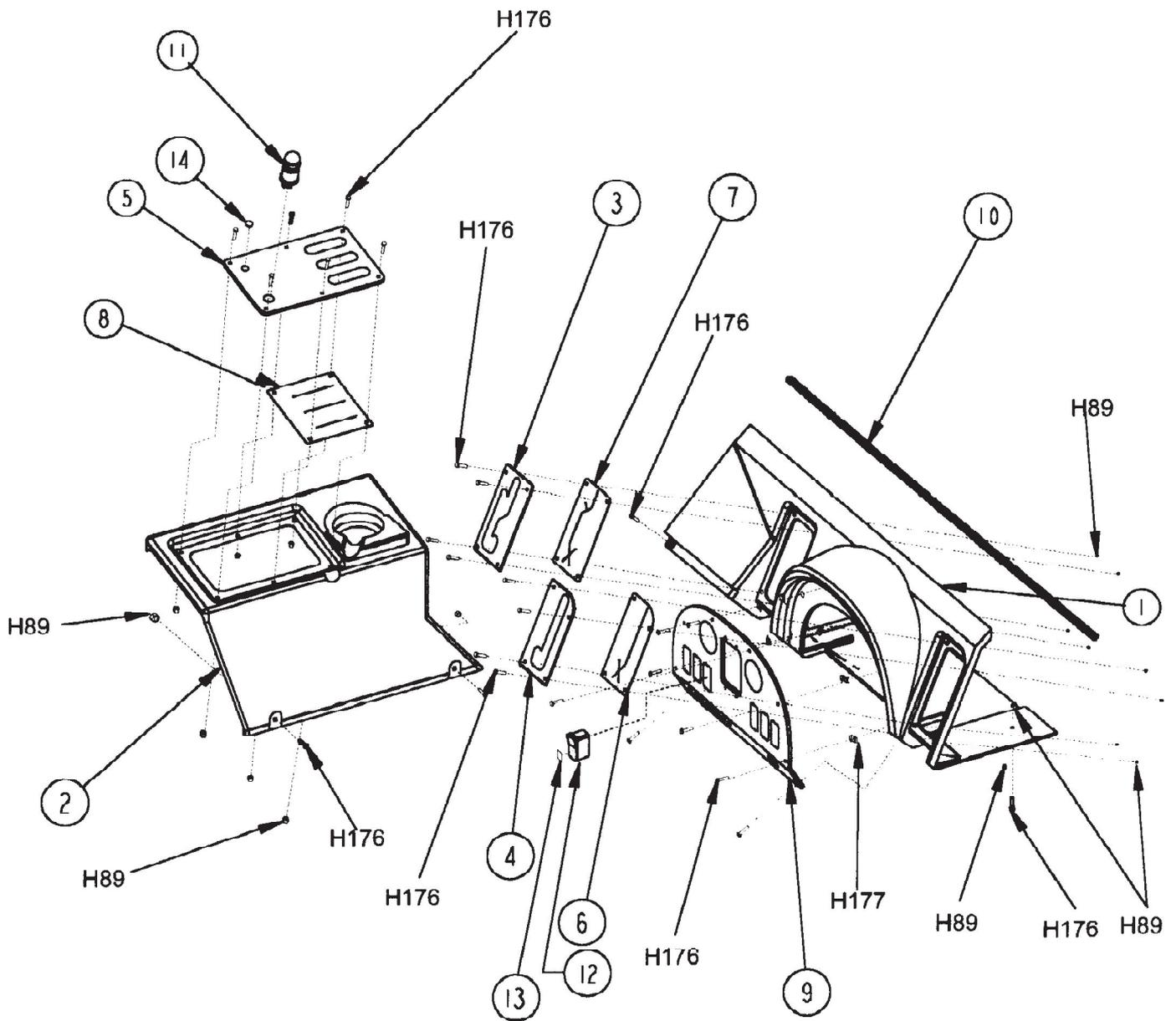

Referenznummer	Artikelnummer	Menge	Description
1	8-33-05118	1	Instrument Housing
2	8-33-05119	1	Center Wall Housing
3	8-52-00168	1	Panel, Trim Main Broom
4	8-52-00169	1	Panel, Trim Side Broom
5	8-52-00170	1	Panel, Trim Valve
6	8-16-07354	1	Cover, Side Broom Slot
7	8-16-07355	1	Cover, Main Broom Slot
8	8-16-07356	1	Cover, Valve Slot
9	0860-570	1	Instrument Panel Assembly
10	8-68-05081	1	Trim Seal
11	8-82-00024	1	Horn Button
12	8-82-00054	1	Switch, Glow Plugs (On)/Off, SPST
13	8-41-03005	1	Switch Lens, Glow Plugs
14	2-00-05283	1	Plug Button for Chole Hole on Diesel
H89	2-00-01372	18	Nut, Fiber Insert #8-32 Steel Hardware
H176	2-00-05337	27	Screw, #8-32 x .750 BHS SS Hardware
H177	2-00-05324	9	Threaded Insert, #8-32 Hardware
	8-82-00053		Switch, Lights On/Off, SPST Instrument Panel Service Parts
	8-82-00053		Switch, Work Lights, On/Off, SPST Instrument Panel Service Parts
	8-82-00053		Switch, Dust Control, On/Off, SPST Instrument Panel Service Parts
	8-82-00054		Switch, Filter Shaker (On)/Off, SPST Instrument Panel Service Parts
	8-82-00055		Switch, Engine Speed On/On/On, SPTT Instrument Panel Service Parts
	8-41-03003		Switch Lens, Lights Instrument Panel Service Parts
	8-41-03004		Switch Lens, Work Light Instrument Panel Service Parts
	8-41-03006		Switch Lens, Filter Shaker Instrument Panel Service Parts
	8-41-03007		Switch Lens, Dust Control Instrument Panel Service Parts
	8-41-03008		Switch Lens, Engine Speed Instrument Panel Service Parts
	2-00-05272		Switch Blank Instrument Panel Service Parts
	8-40-05047		Light Bulb, Switch Instrument Panel Service Parts
	8-40-05048		Light Bulb, Warning Bank Indicators Instrument Panel Service Parts
	8-40-05048		Light Bulb, Backlight Instrument Panel Service Parts
	2-00-05273		Bulb Filter, Red Instrument Panel Service Parts
	2-00-05274		Bulb Filter, Yellow Instrument Panel Service Parts

Referenznummer	Artikelnummer	Menge	Description
	2-00-05275		Lamp Socket For Backlight, With Leads Instrument Panel Service Parts
	2-00-04757		Hole Plug, .375 Dia. Instrument Panel Service Parts
	0895-111-1		Dash Panel Wiring Harness W/Connectors Instrument Panel Service Parts
	8-52-00167		Instrument Panel Instrument Panel Service Parts
	8-48-05023		Hour Meter Instrument Panel Service Parts
	8-48-05032		Fuel Gauge Instrument Panel Service Parts
	8-64-00008		Circuit Breaker-15 A Instrument Panel Service Parts
	7-64-00022		Circuit Breaker-20 A Instrument Panel Service Parts
	8-11-00044		Boot For Circuit Breaker Instrument Panel Service Parts
	7-82-00026		Key Switch Instrument Panel Service Parts

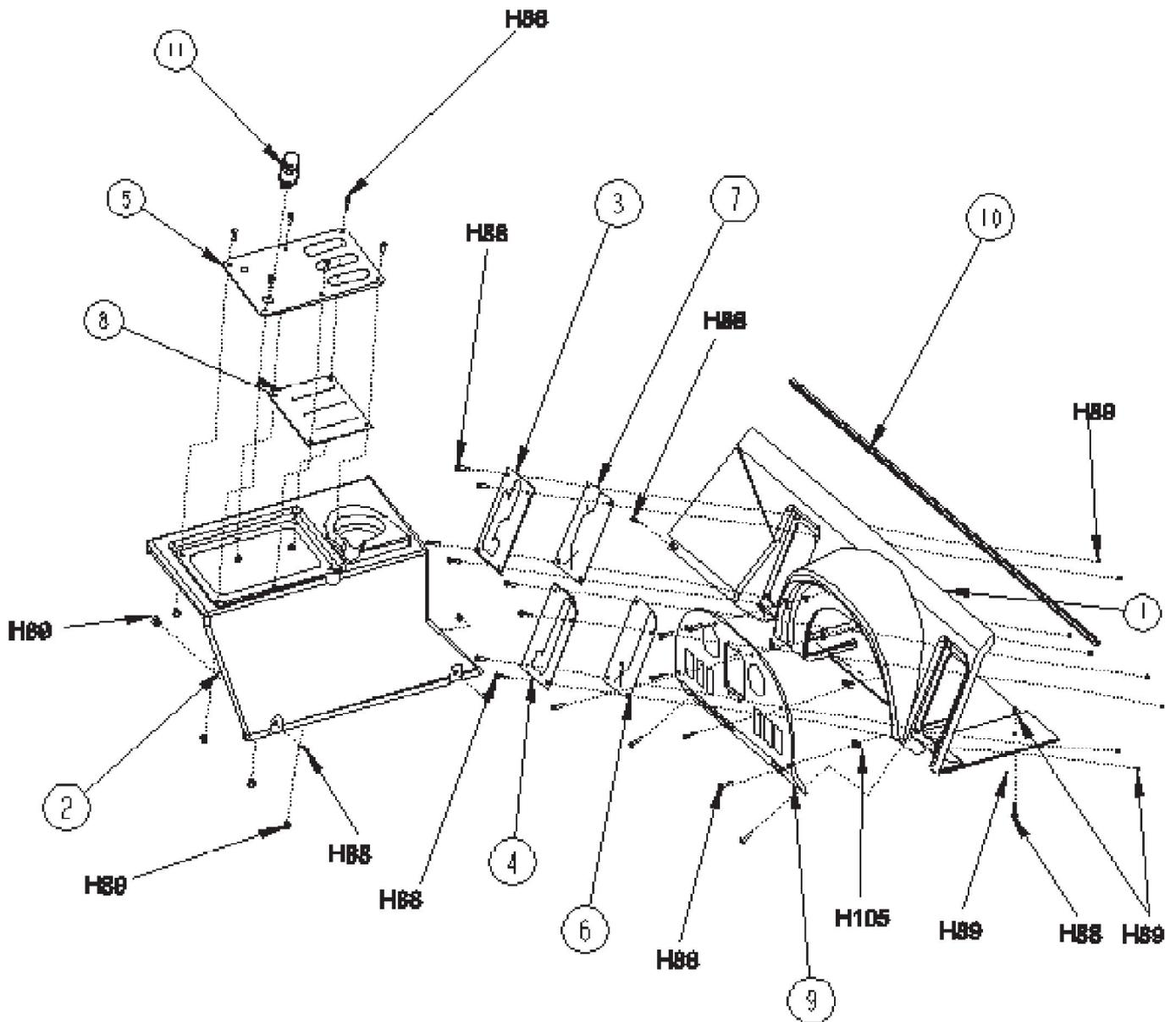

Referenznummer	Artikelnummer	Menge	Description
1	8-33-05118	1	Instrument Housing
2	8-33-05119	1	Center Wall Housing
3	8-52-00168	1	Panel, Trim Main Broom
4	8-52-00169	1	Panel, Trim Side Broom
5	8-52-00170	1	Panel, Trim Valve
6	8-16-07354	1	Cover, Side Broom Slot
7	8-16-07355	1	Cover, Main Broom Slot
8	8-16-07356	1	Cover, Valve Slot
9	0860-570	1	Instrument Panel Assembly
	8-82-00053		Switch, Lights On/Off, SPST
	8-82-00053		Switch, Work Lights, On/Off, SPST
	8-82-00053		Switch, Dust Control, On/Off, SPST
	8-82-00054		Switch, Glow Plugs (On)/Off, SPST
	8-82-00054		Switch, Filter Shaker (On)/Off, SPST
	8-82-00055		Switch, Engine Speed On/On/On, SPTT
	8-41-03003		Switch Lens, Lights
	8-41-03004		Switch Lens, Work Light
	8-41-03005		Switch Lens, Glow Plugs
	8-41-03006		Switch Lens, Filter Shaker
	8-41-03007		Switch Lens, Dust Control
	8-41-03008		Switch Lens, Engine Speed
	2-00-05272		Switch Blank
	8-40-05047		Light Bulb, Switch
	8-40-05048		Light Bulb, Warning Bank Indicators
	8-40-05048		Light Bulb, Backlight
	2-00-05273		Bulb Filter, Red
	2-00-05274		Bulb Filter, Yellow
	2-00-05275		Lamp Socket For Backlight, w/Leads
	2-00-04757		Hole Plug, .375 Dia.
	0895-111-1		Dash Panel Wiring Harness w/Connectors
	8-52-00167		Instrument Panel
	8-48-05023		Hour Meter
	8-48-05032		Fuel Gauge
	8-64-00008		Circuit Breaker-15 A
	7-64-00022		Circuit Breaker-20 A
	8-11-00044		Boot For Circuit Breaker
	7-82-00026		Key Switch
	2-00-05283		Plug Button For Choke hole on Diesel
10	8-68-05081	1	Trim Seal
11	8-82-00024	1	Horn Button
H88	2-00-05258	27	Screw, #8-325 x .750 BHS
H89	2-00-01372	18	Nut, Fiber Insert #8-32 Steel
H105	2-00-05260	9	Nut, Jam #8-32

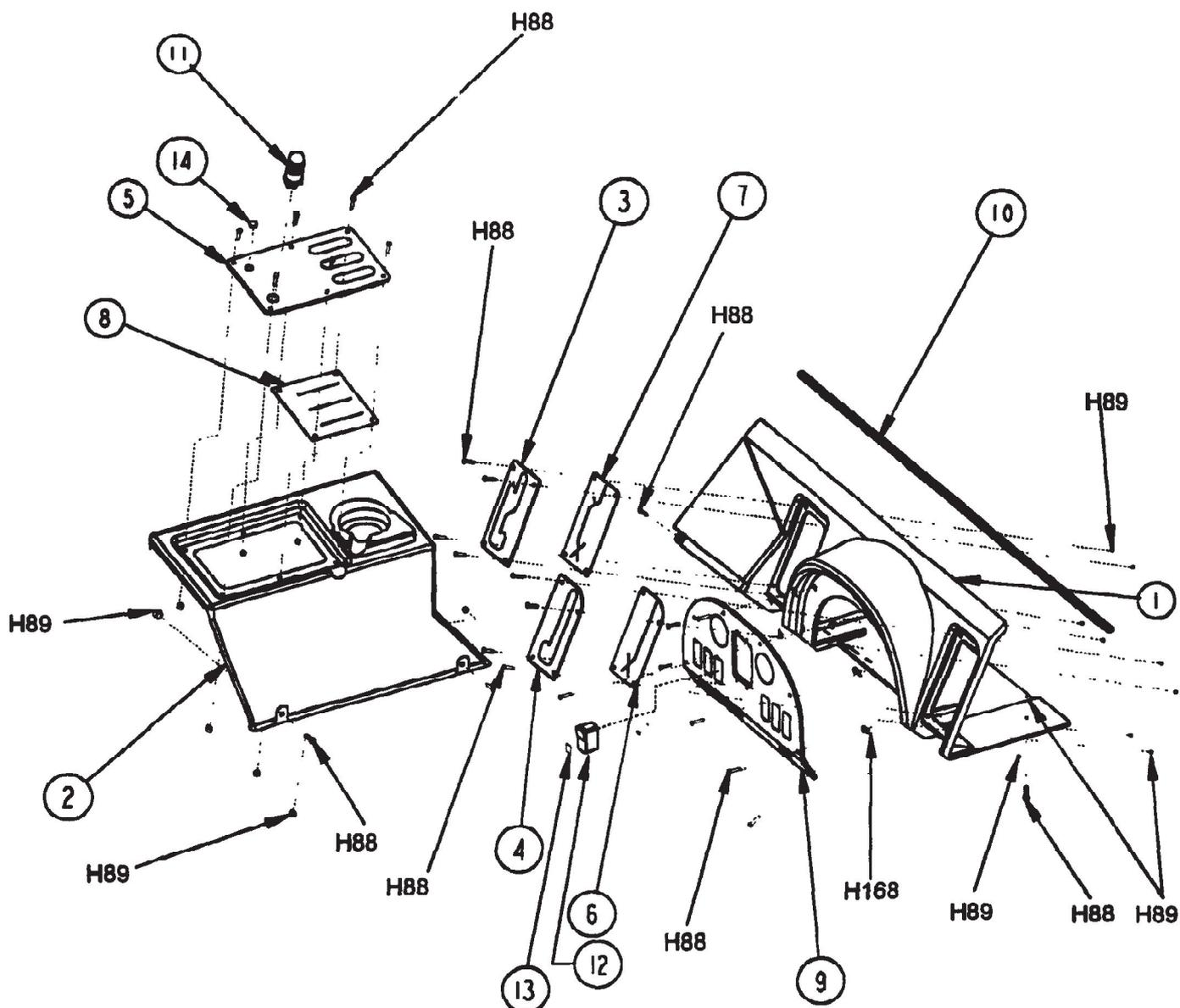

Referenznummer	Artikelnummer	Menge	Description
1	8-33-05118	1	Instrument Housing
2	8-33-05119	1	Center Wall Housing
3	8-52-00168	1	Panel, Trim Main Broom
4	8-52-00169	1	Panel, Trim Side Broom
5	8-52-00170	1	Panel, Trim Valve
6	8-16-07354	1	Cover, Side Broom Slot
7	8-16-07355	1	Cover, Main Broom Slot
8	8-16-07356	1	Cover, Valve Slot
9	0860-570	1	Instrument Panel Assembly
10	8-68-05081	1	Trim Seal
11	8-82-00024	1	Horn Button
12	8-82-00054	1	Switch, Glow Plugs (On)/Off, SPST
13	8-41-03005	1	Switch Lens, Glow Plugs
14	2-00-05283	1	Plug Button for Chole Hole on Diesel
H88	2-00-05258	27	Screw, #8-325 x .750 BHS HARDWARE
H89	2-00-01372	18	Nut, Fiber Insert #8-32 Steel HARDWARE
H168	2-00-05324	9	Screw, #8-32 x .625 RHM HARDWARE
	8-82-00053		Switch, Lights On/Off, SPST INSTRUMENT PANEL SERVICE PARTS
	8-82-00053		Switch, Work Lights, On/Off , SPST INSTRUMENT PANEL SERVICE PARTS
	8-82-00053		Switch, Dust Control, On/Off, SPST INSTRUMENT PANEL SERVICE PARTS
	8-82-00054		Switch, Filter Shaker (On)/Off, SPST INSTRUMENT PANEL SERVICE PARTS
	8-82-00055		Switch, Engine Speed On/On/On, SPTT INSTRUMENT PANEL SERVICE PARTS
	8-41-03003		Switch Lens, Lights INSTRUMENT PANEL SERVICE PARTS
	8-41-03004		Switch Lens, Work Light INSTRUMENT PANEL SERVICE PARTS
	8-41-03006		Switch Lens, Filter Shaker INSTRUMENT PANEL SERVICE PARTS
	8-41-03007		Switch Lens, Dust Control INSTRUMENT PANEL SERVICE PARTS
	8-41-03008		Switch Lens, Engine Speed INSTRUMENT PANEL SERVICE PARTS
	2-00-05272		Switch Blank INSTRUMENT PANEL SERVICE PARTS
	8-40-05047		Light Bulb, Switch INSTRUMENT PANEL SERVICE PARTS
	8-40-05048		Light Bulb, Warning Bank Indicators INSTRUMENT PANEL SERVICE PARTS
	8-40-05048		Light Bulb, Backlight INSTRUMENT PANEL SERVICE PARTS
	2-00-05273		Bulb Filter, Red INSTRUMENT PANEL SERVICE PARTS

Referenznummer	Artikelnummer	Menge	Description
	2-00-05274		Bulb Filter, Yellow INSTRUMENT PANEL SERVICE PARTS
	2-00-05275		Lamp Socket For Backlight, With Leads INSTRUMENT PANEL SERVICE PARTS
	2-00-04757		Hole Plug, .375 Dia. INSTRUMENT PANEL SERVICE PARTS
	0895-111-1		Dash Panel Wiring Harness W/Connectors INSTRUMENT PANEL SERVICE PARTS
	8-52-00167		Instrument Panel INSTRUMENT PANEL SERVICE PARTS
	8-48-05023		Hour Meter INSTRUMENT PANEL SERVICE PARTS
	8-48-05032		Fuel Gauge INSTRUMENT PANEL SERVICE PARTS
	8-64-00008		Circuit Breaker-15 A INSTRUMENT PANEL SERVICE PARTS
	7-64-00022		Circuit Breaker-20 A INSTRUMENT PANEL SERVICE PARTS
	8-11-00044		Boot For Circuit Breaker INSTRUMENT PANEL SERVICE PARTS
	7-82-00026		Key Switch INSTRUMENT PANEL SERVICE PARTS

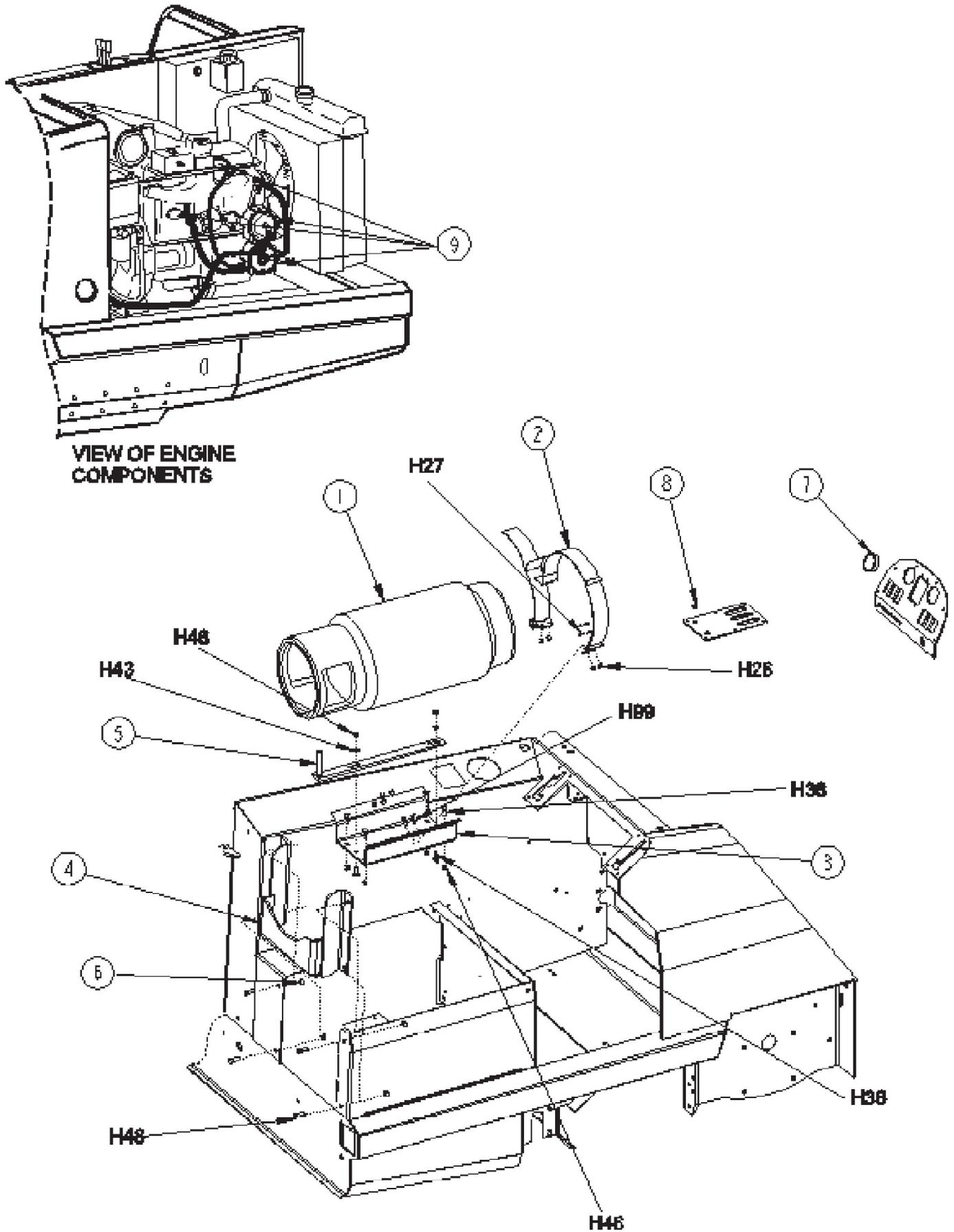

Referenznummer	Artikelnummer	Menge	Description
1	8-83-04016	1	LP Tank
2	8-41-00055	1	Bracket, LP Tank
3	8-08-00813	1	Bracket, LP Tank
4	8-30-05171	1	Guard, LP Tank Weld
5	8-43-05005	1	Locate Pin, LP Tank
6	2-95-04182	4	Nut, Fiber
7	2-00-05281	1	Plug Button
8	2-00-05283	1	Plug Button
9	8-11-04023	1	2160 Ford 411 LP Kit
H26	2-00-00641	4	Nut, 1/4-20 Insert Fiber Hardware
H35	2-00-02708	6	Screw, 5/16-18 x 1.000 HHM Hardware
H43	2-00-00409	2	Flat Washer, .687 x .344 x .062 Hardware
H46	2-00-00644	6	Nut, 5/16-18, Insert Fiber Hardware
H48	2-00-00233	4	Screw, 3/8-16 x 1.000 HHC Hardware
H89	2-00-01372	4	Nut, Fiber Insert #8-32 Steel Hardware
	2-60-02292	1	Hose, LP Gas (Liquid) 94.00 Lg. LP Service Parts
	2-60-02293	1	Regulator LP Service Parts
	2-60-02294	1	Vacuum Fuelock Filter LP Service Parts

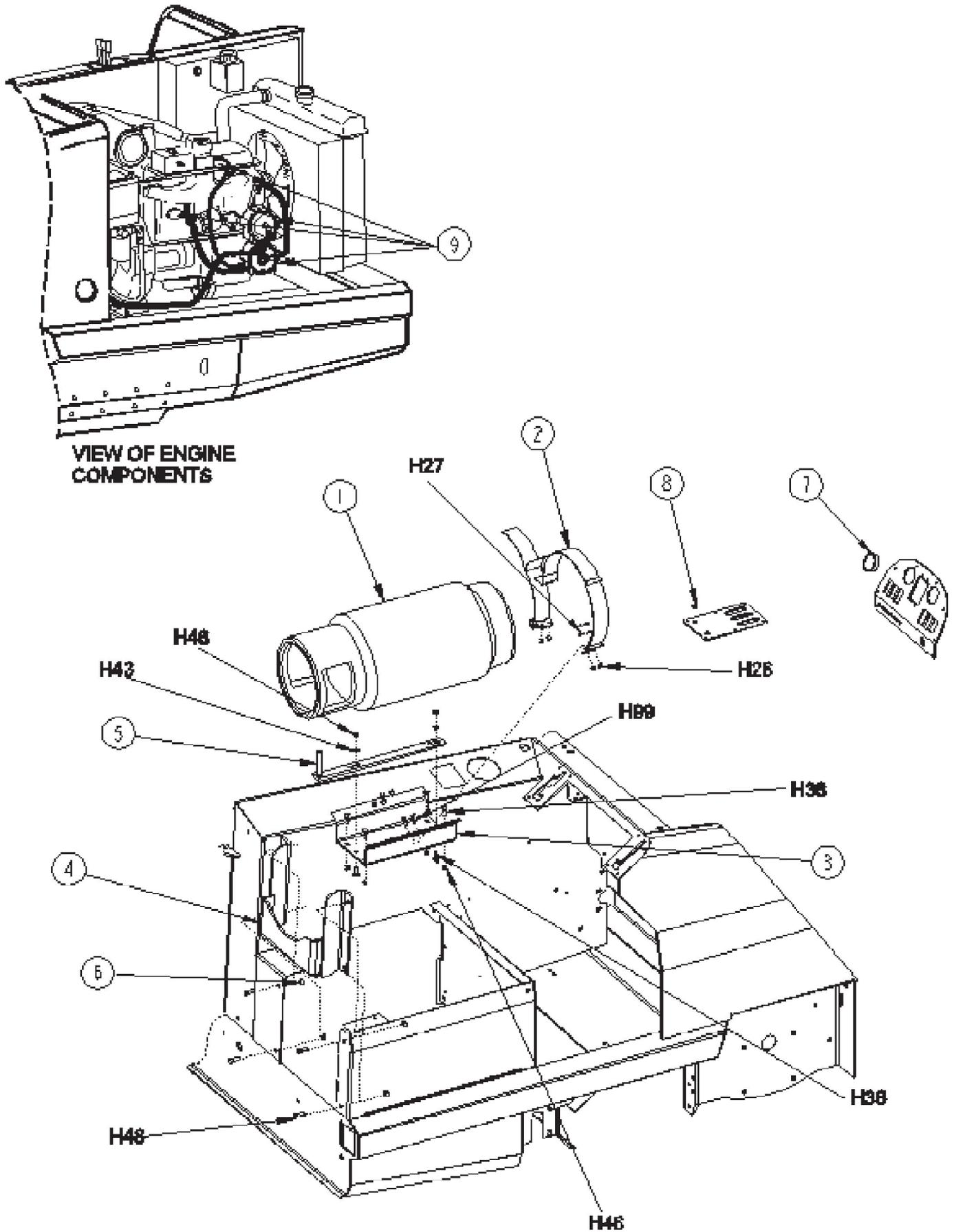

Referenznummer	Artikelnummer	Menge	Description
	0880-611		LP Ford 411 Engine Option
1	8-83-04016	1	LP Tank
2	8-41-00055	1	Bracket, LP Tank
3	8-08-00813	1	Bracket, LP Tank
4	8-30-05171	1	Guard, LP Tank Weld
5	8-43-05005	1	Locate Pin, LP Tank
6	2-95-04182	4	Nut, Fiber
7	2-00-05281	1	Plug Button
8	2-00-05283	1	Plug Button
9	8-11-04023	1	2160 Ford 411 LP Kit
H26	2-00-00641	4	Nut, 1/4-20 Insert Fiber
H27			UNKNOWN
H35	2-00-02708	6	Screw, 5/16-18 x 1.000 HHM
H36			UNKNOWN
H43	2-00-00409	2	Flat Washer, .687 x .344 x .062
H46	2-00-00644	6	Nut, 5/16-18, Insert Fiber
H48	2-00-00233	4	Screw, 3/8-16 x 1.000 HHC
H89	2-00-01372	4	Nut, Fiber Insert #8-32 Steel
H99			UNKNOWN

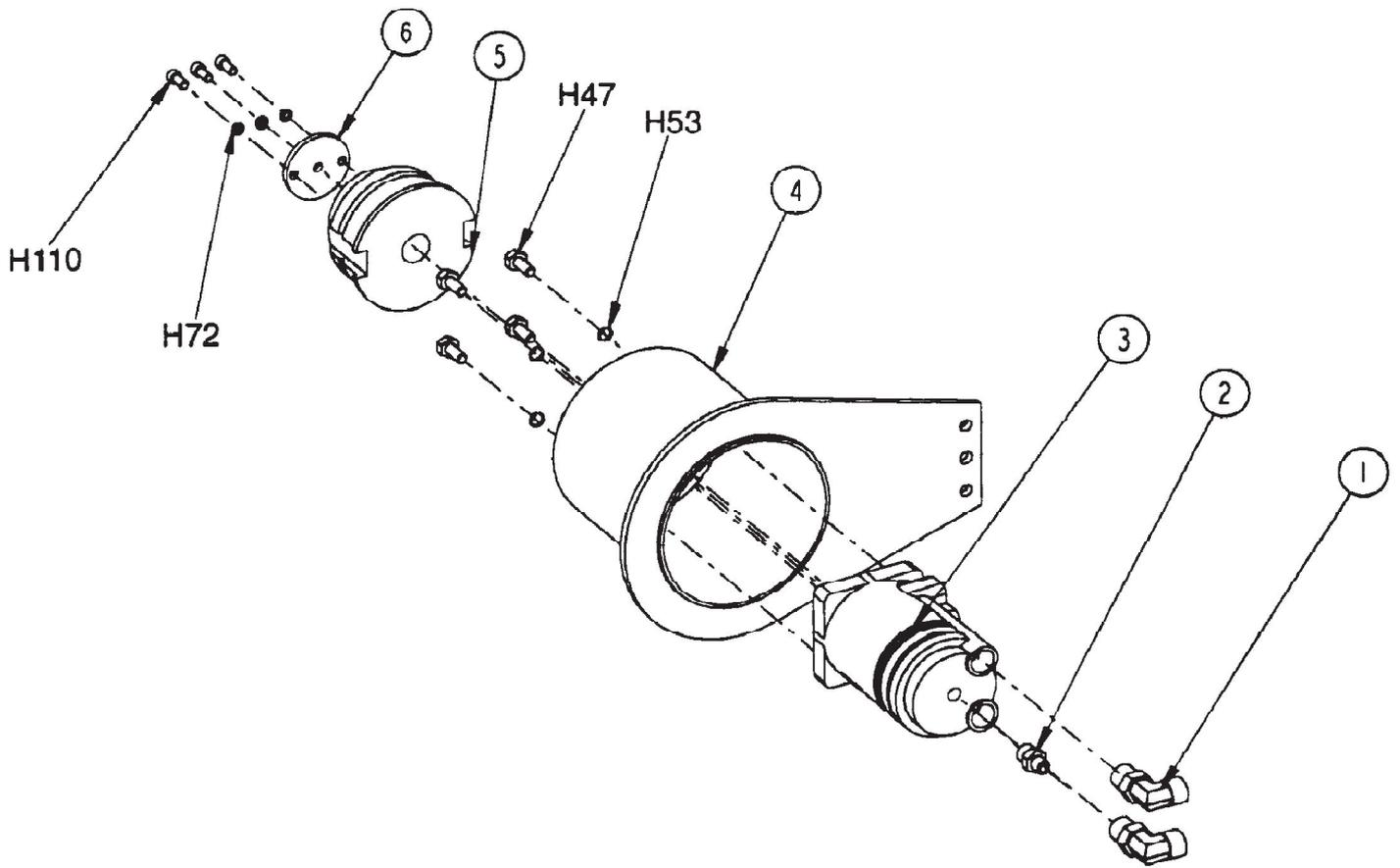

Referenznummer	Artikelnummer	Menge	Description
1	2-00-04885	2	Fitting
2	2-00-04895	1	Fitting
3	0882-040	1	Motor
0	880-448		Motor Seal Kit (Service Part)
4	8-16-00041	1	Drive Broom Arm
5	8-33-09046-1	1	Driver, Hub
6	8-58-05160	1	Hub, Lock Plate
H47	2-00-00232	4	Screw, 3/8-16 x .750 HHC
H53	2-00-02310		Lock Washer, Helical Spring 3/8 Med.
H72	2-00-00518	3	Lock Washer, Helical Spring
H110			UNKNOWN
H116	2-00-03039	3	Screw, 1/4-20 x .625 HSHC

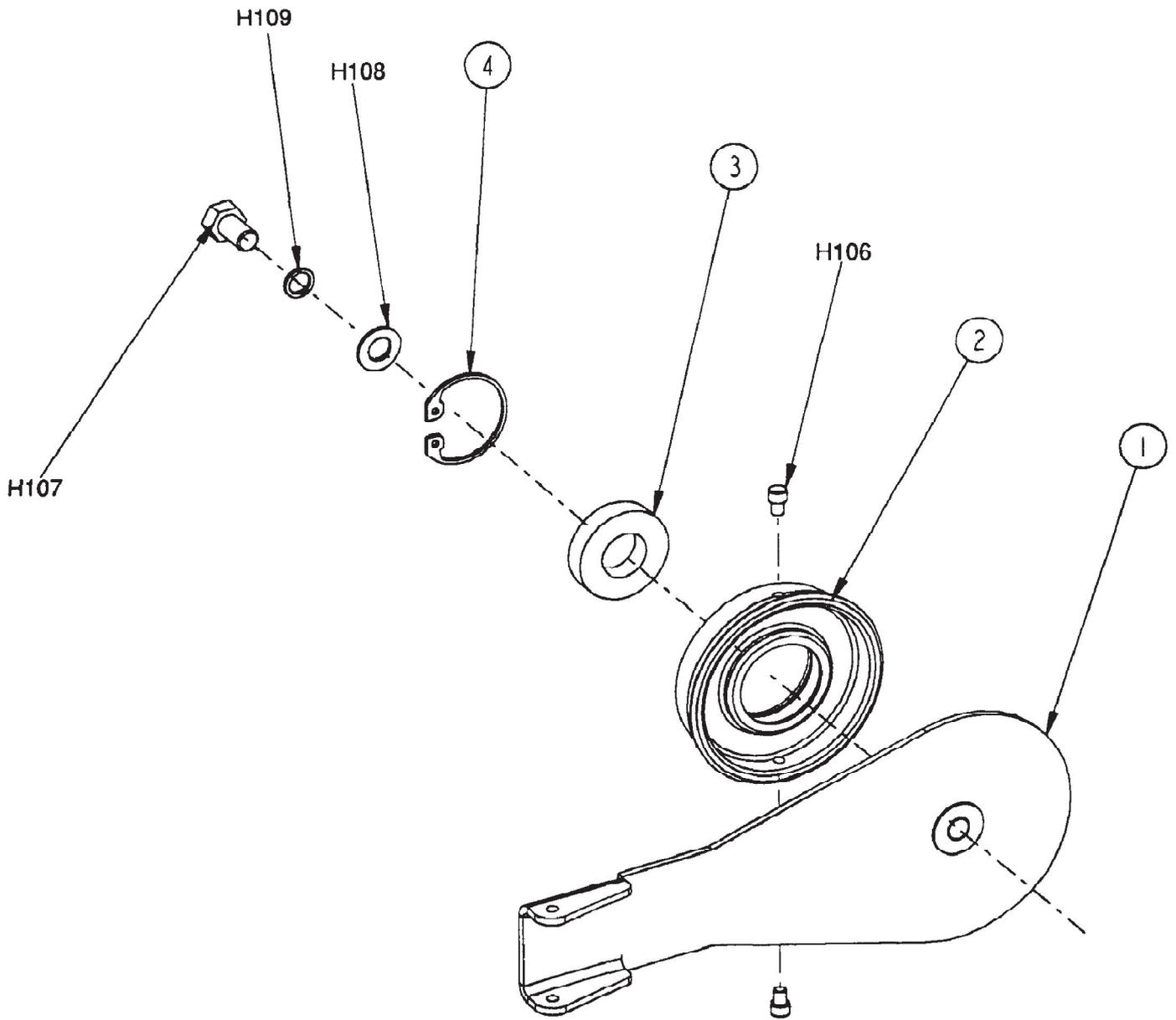

Referenznummer	Artikelnummer	Menge	Description
1	8-16-00053	1	Broom Idler Arm
2	8-33-09090	1	Idler, Machined
3	2-00-04889	1	Bearing
4	2-00-04890	1	Clip, Retainer
H106	2-00-04886	2	Screw, 3/8-16 x .500 HSHC
H107	2-00-04887	1	Screw
H108			UNKNOWN
H109			UNKNOWN

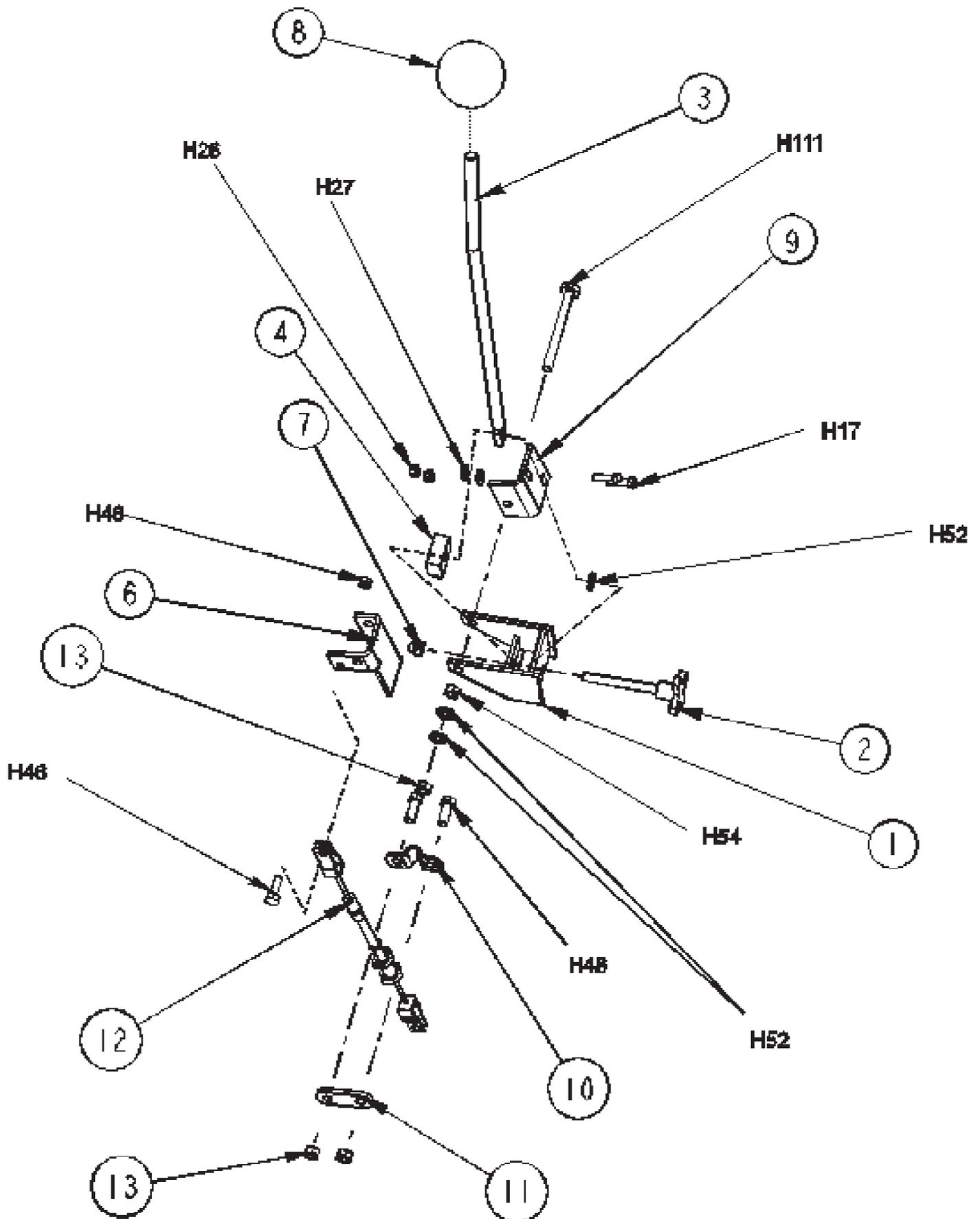

Referenznummer	Artikelnummer	Menge	Description
1	8-08-00773	1	Broom Lift Main Broom/Side Broom Weldment
2	8-39-00012	1	Knob Assembly
3	8-66-00166	1	Lever Handle
4	8-50-03002	1	Broom Adjustment Block
6	8-08-00774	1	Adjustment Angle/Main Broom
7	2-00-00650	1	Nut, Low Crown 3/8-16
8	8-39-00003	1	Control Knob, Small
9	8-08-00779	1	Pivot, Main Broom Lift
10	8-13-07120	1	Cable Clamp
11	8-75-01198	1	Spacer
12	8-10-00037	1	Cable
13	2-95-04182	3	Stop Nut, Elastic
H17	2-00-00205	2	Screw, 1/4-20 x 1.000 HHC
H26	2-00-00641	2	Nut, 1/4-20 Insert Fiber
H27	2-00-03702	2	Washer, .625 x .281 x .063
H35	2-00-02708	1	Screw, 5/16-18 x 1.000 HHM
H46	2-00-00644	1	Nut, 5/16-18, Insert Fiber
H48	2-00-00233	2	Screw, 3/8-16 x 1.000 HHC
H52	2-00-00402	2	Flat Washer, .750 x .390 x .094
H54	2-00-02360	1	Nut, 3/8-16 Hex.
H111	2-00-03296	1	Screw, 3/8-16 x 4.000 HHC

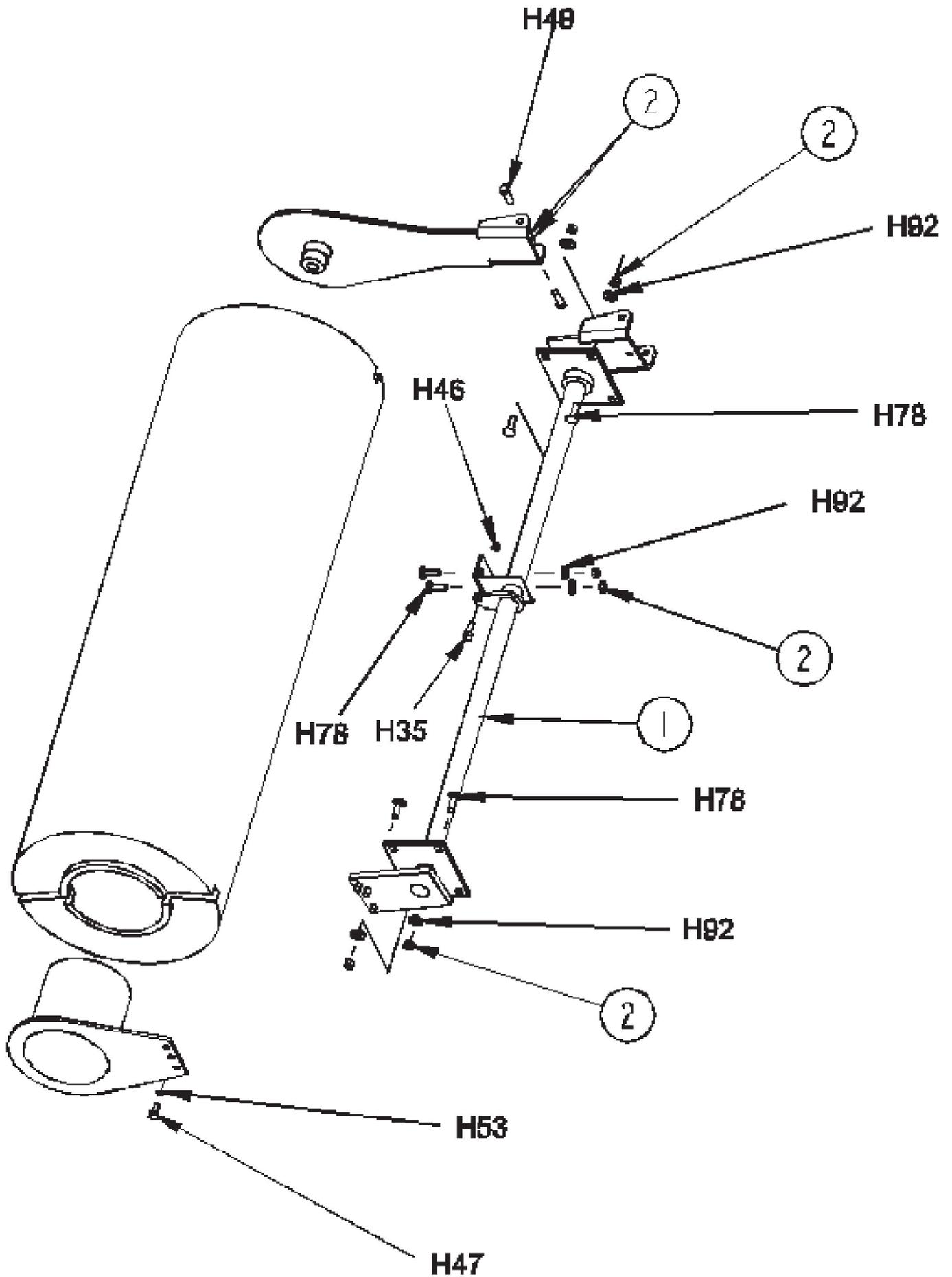

Referenznummer	Artikelnummer	Menge	Description
1	8-03-04301	1	Main Broom Lift Frame Assembly
2	2-95-04182	8	Nut, Elastic Stop
H35	2-00-02708	1	Screw, 5/16-18 x 1.000 HHM
H46	2-00-00644	1	Nut, 5/16-18, Insert Fiber
H47	2-00-00232	1	Screw, 3/8-16 x .750 HHC
H49	2-00-00209	2	Screw, 3/8-16 x 1.250 HHC
H53	2-00-02310		Lock Washer, Helical Spring 3/8 Med.
H78	2-00-05187	6	Carriage Bolt, 3/8-16 x 1.250
H92	2-00-04801	6	Flat Washer, .875 x .375 x .125

Supplied With Diesel Engine

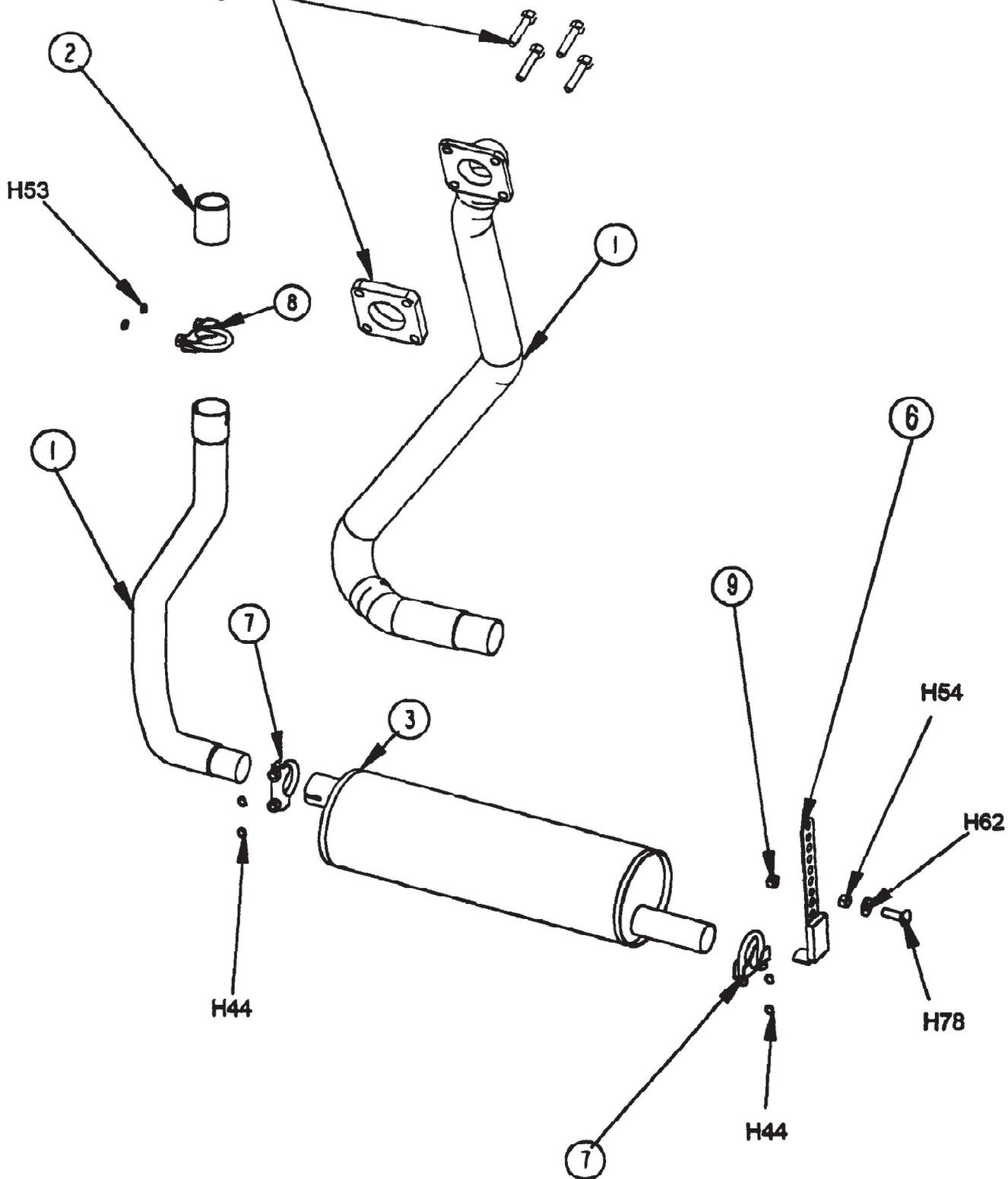

Referenznummer	Artikelnummer	Menge	Description
1	8-56-04045	1	Exhaust Pipe
	8-56-04050	1	Exhaust Pipe (Diesel) Not Shown
2	8-56-05079	1	Fitting, Pipe Nipple
3	7-49-00031	1	Muffler
6	7-31-07017	1	Hanger, Muffler
7	2-00-04040	1	Clamp
8	2-00-05149	1	Clamp
9	2-95-04182	1	Nut, Fiber
H44	2-00-00530	4	Lock Washer, 5/16 HS Med. HARDWARE
H53	2-00-02310	2	Lock Washer, Helical Spring 3/8 Med. HARDWARE
H54	2-00-02360	1	Nut, 3/8-16 Hex. HARDWARE
H62	2-00-00405	1	Flat Washer, 1.063 x .531 x .094 HARDWARE
H78	2-00-05187	1	Carriage Bolt, 3/8-16 x 1.250 HARDWARE

Supplied With Diesel Engine

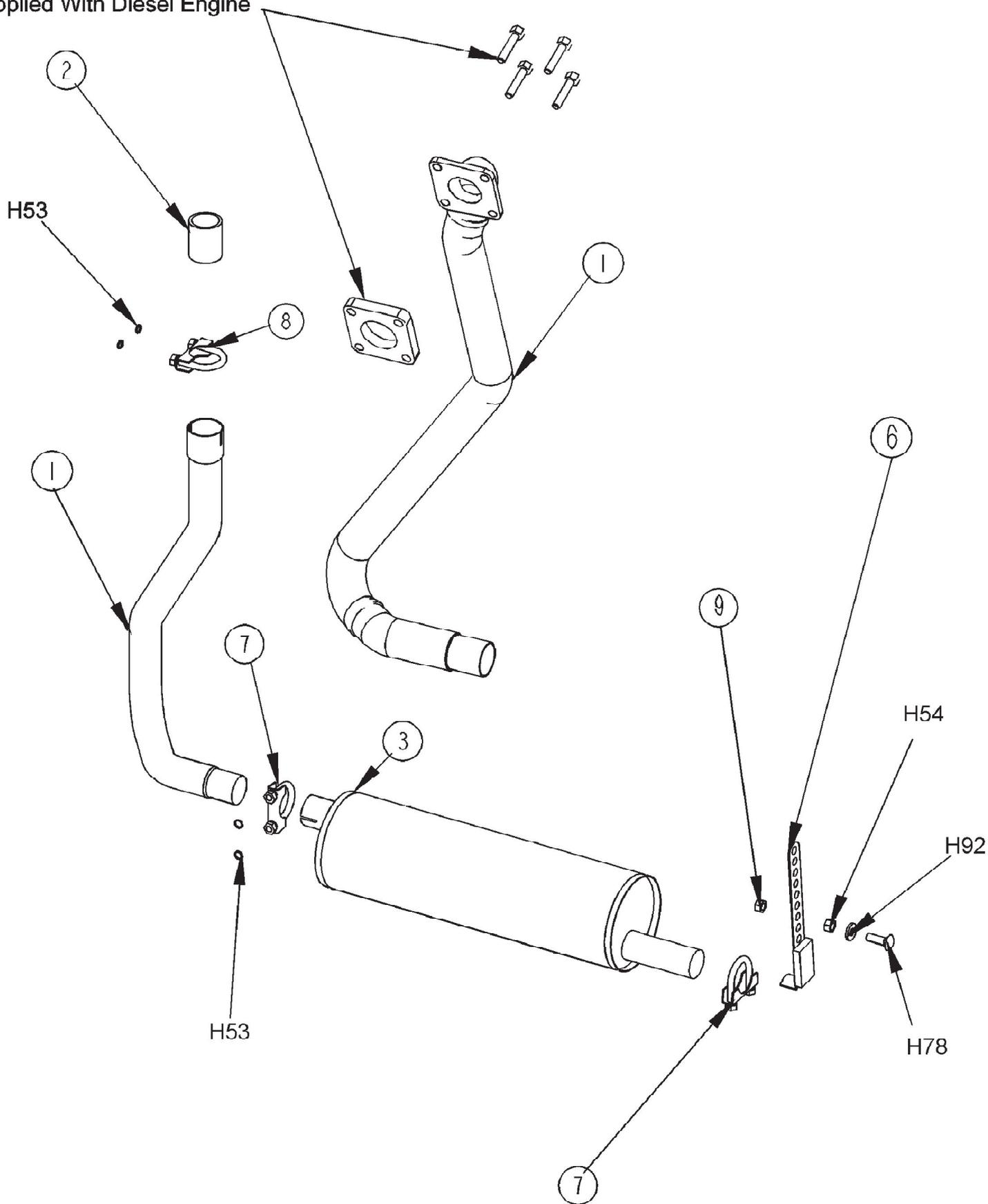

Referenznummer	Artikelnummer	Menge	Description
1	8-56-04045	1	Exhaust Pipe
1	8-56-04046	1	Exhaust Pipe (Diesel)
2	8-56-05079	1	Fitting, Pipe Nipple
3	7-49-00031	1	Muffler
6	7-31-07017	1	Hanger, Muffler
7	2-00-04040	1	Clamp
8	2-00-05149	1	Clamp
9	2-95-04182	1	Nut, Fiber
H53	2-00-02310	4	Lock Washer, Helical Spring 3/8 Med.
H54	2-00-02360	1	Nut, 3/8-16 Hex.
H78	2-00-05187	1	Carriage Bolt, 3/8-16 x 1.250
H92	2-00-04801	1	Flat Washer, .875 x .375 x .125

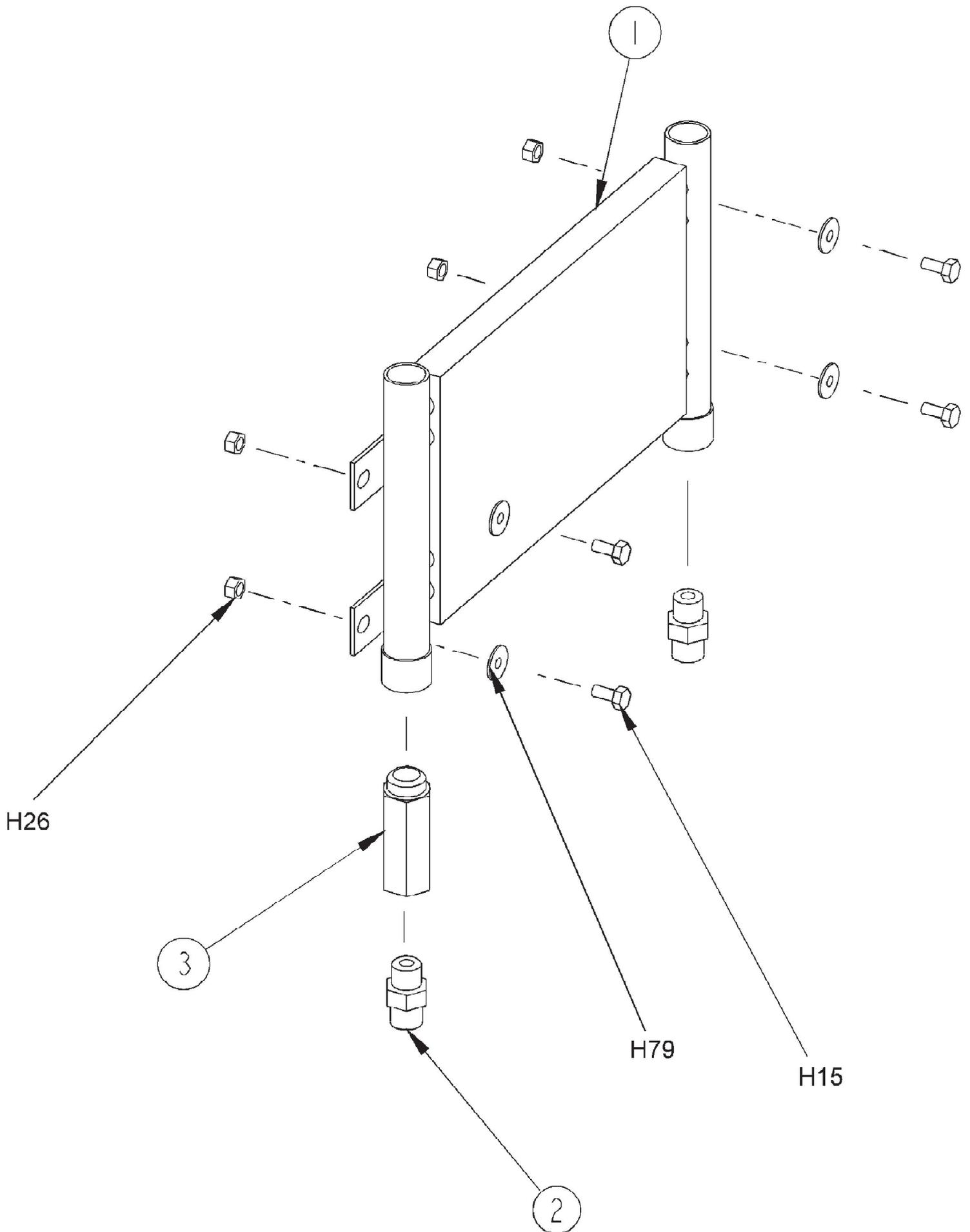

Referenznummer	Artikelnummer	Menge	Description
1	8-62-01012	1	Oil Cooler
2	2-00-04973	2	Fitting
3	8-88-00059	1	Check Valve, 5 psi
H15	2-00-00221	4	Screw, 1/4-20 x .750 HHC
H26	2-00-00641	4	Nut, 1/4-20 Insert Fiber
H79	2-00-01676	4	Flat Washer, 1.062 x .265 x .062

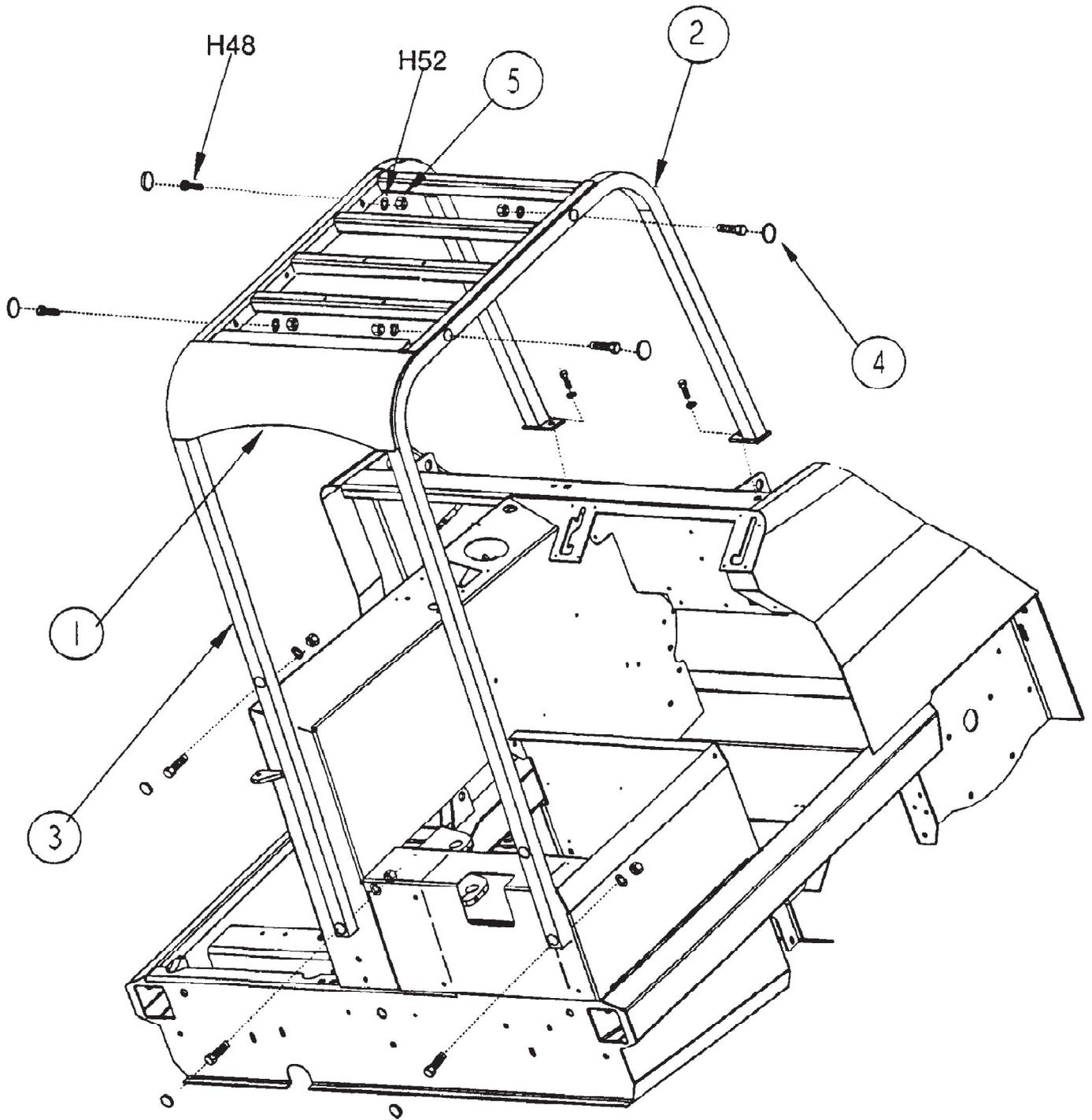

Referenznummer	Artikelnummer	Menge	Description
	0880-601		Overhaed Guard Option
1	8-30-05174	1	Overhead Guard, Top Weld
2	8-30-05172	1	Overhead Guard, Leg Weld R.H.
3	8-30-05173	1	Overhead Guard, Leg Weld L.H.
4	2-00-05134	8	Plug Button
5	2-95-04182	8	Nut, Fiber
H48			UNKNOWN
H52			UNKNOWN

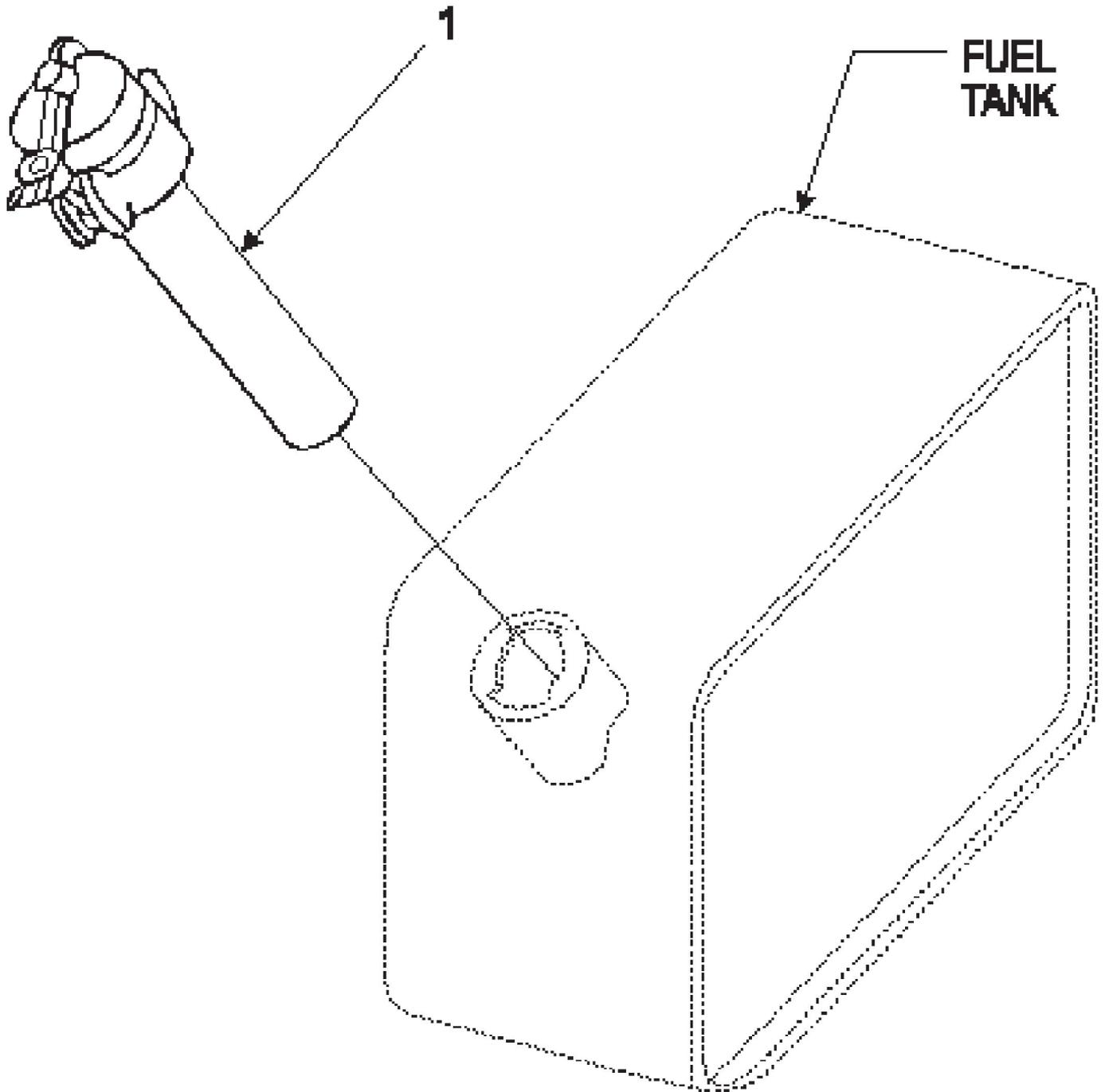

Referenznummer	Artikelnummer	Menge	Description
1	8-11-00024	1	Protoseal Gas Cap

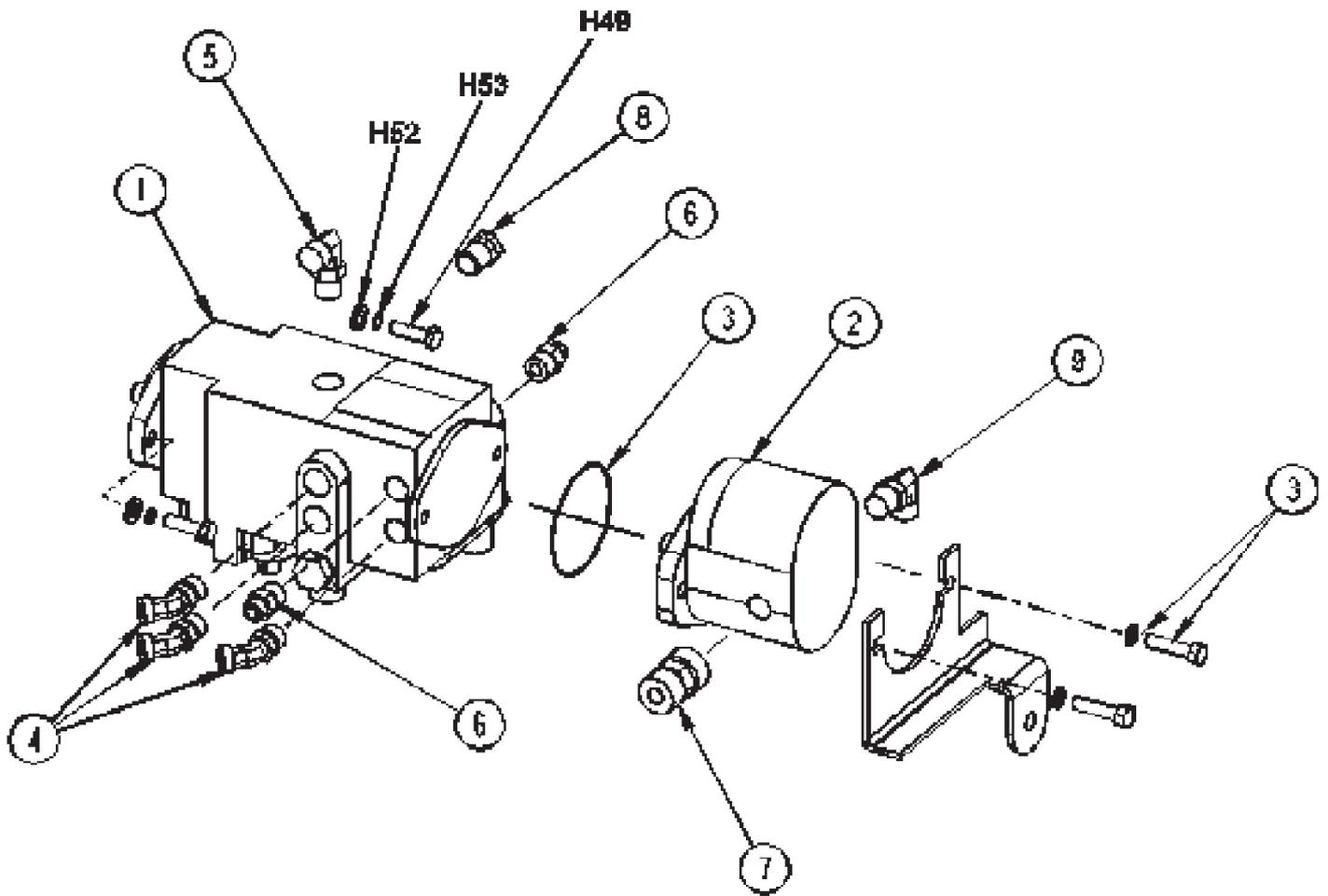

Referenznummer	Artikelnummer	Menge	Description
1	7-60-05023	1	Piston Pump
	7-70-00093		Piston Pump Seal Kit (Service Part)
2	0885-067	1	Gear Pump
	0780-152		Gear Pump Seal Kit (Service Part)
	30880-404		Seal Kit
3			UNKNOWN
4	2-00-04975	3	Fitting, 45ø Elbow
5	2-00-04885	1	Fitting, 90ø Elbow
6	2-00-05264	1	Fitting, Connector
7	2-00-04971	1	Fitting, Connector
8	7-78-05023	1	Pump Stop
9	2-00-04921	1	Fitting, 90ø Elbow
H49	2-00-00209	2	Screw, 3/8-16 x 1.250 HHC
H52	2-00-00402	2	Flat Washer, .750 x .390 x .094
H53	2-00-02310	2	Lock Washer, Helical Spring 3/8 Med.

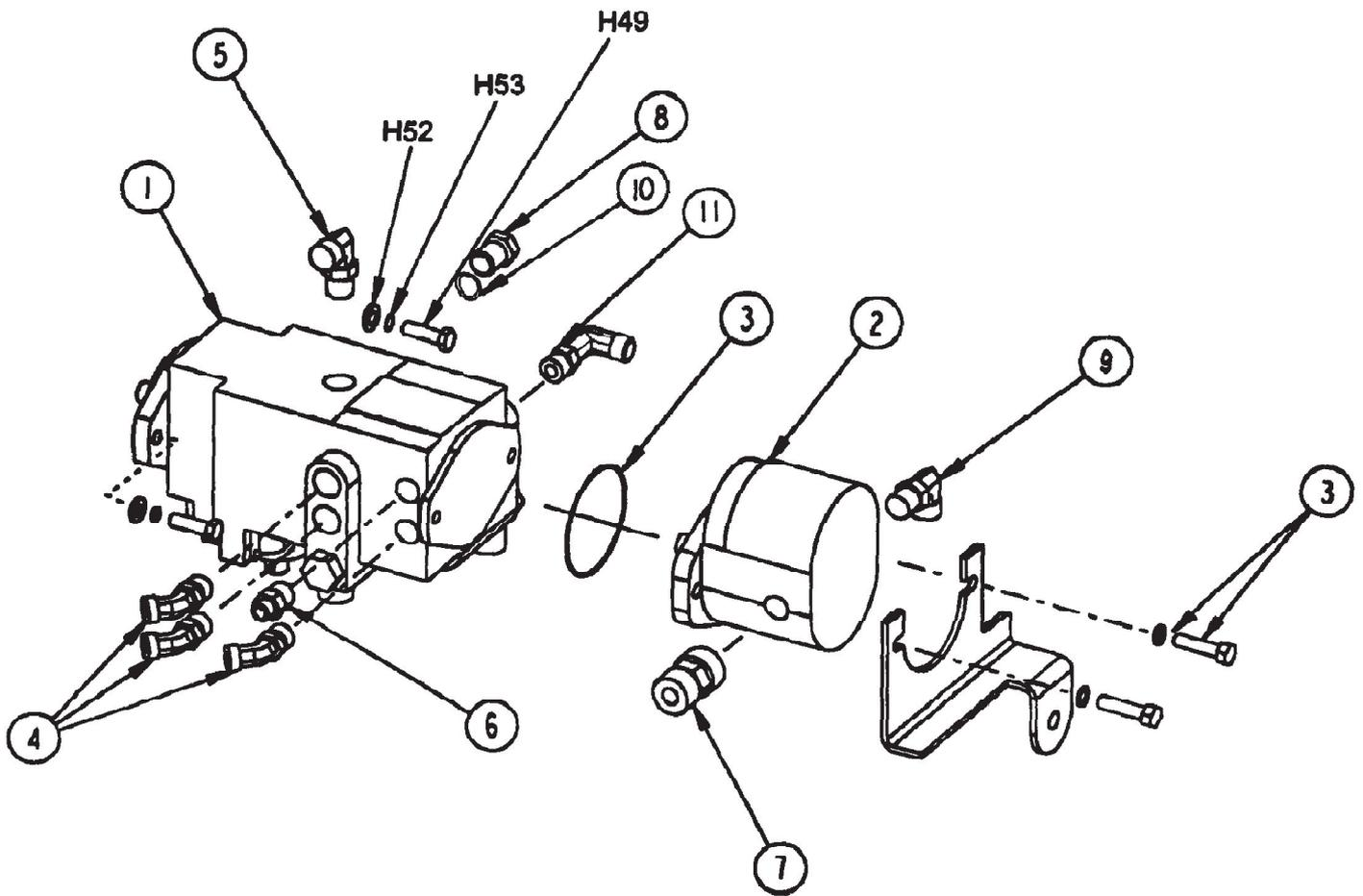

Referenznummer	Artikelnummer	Menge	Description
1	7-60-05023	1	Piston Pump
	7-70-00093	1	Piston Pump Seal Kit (Service Part)
2	0885-067	1	Gear Pump
	0780-152	1	Gear Pump Seal Kit (Service Part)
	0880-404	1	Seal Kit
3			UNKNOWN
4	2-00-04975	3	Fitting, 45ø Elbow
5	2-00-04885	1	Fitting, 90ø Elbow
6	2-00-05264	1	Fitting, Connector
7	2-00-04971	1	Fitting, Connector
8	7-78-05023	1	Pump Stop
9	2-00-04921	1	Fitting, 90ø Elbow
10	2-00-04983	1	O-Ring
11	2-00-05316	1	Fitting
H49	2-00-00209	2	Screw, 3/8-16 x 1.250 HHC HARDWARE
H52	2-00-00402	2	Flat Washer, .750 x .390 x .094 HARDWARE
H53	2-00-02310	2	Lock Washer, Helical Spring 3/8 Med. HARDWARE

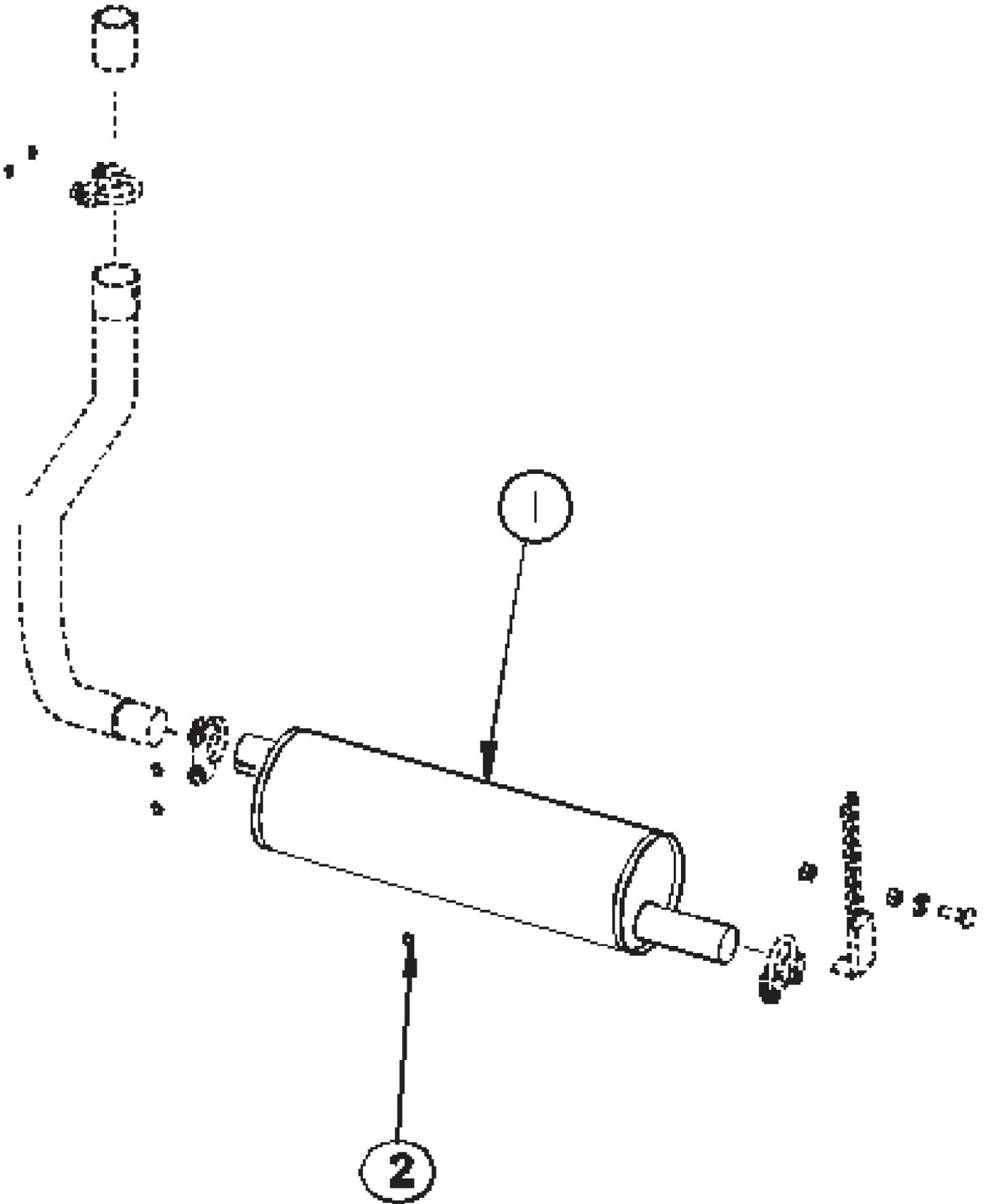

Referenznummer	Artikelnummer	Menge	Description
	0780-146		Purifier Muffler Option
1	7-49-00032	1	Purifier Muffler
2	2-00-02476	1	Plug, 1/8 NPT

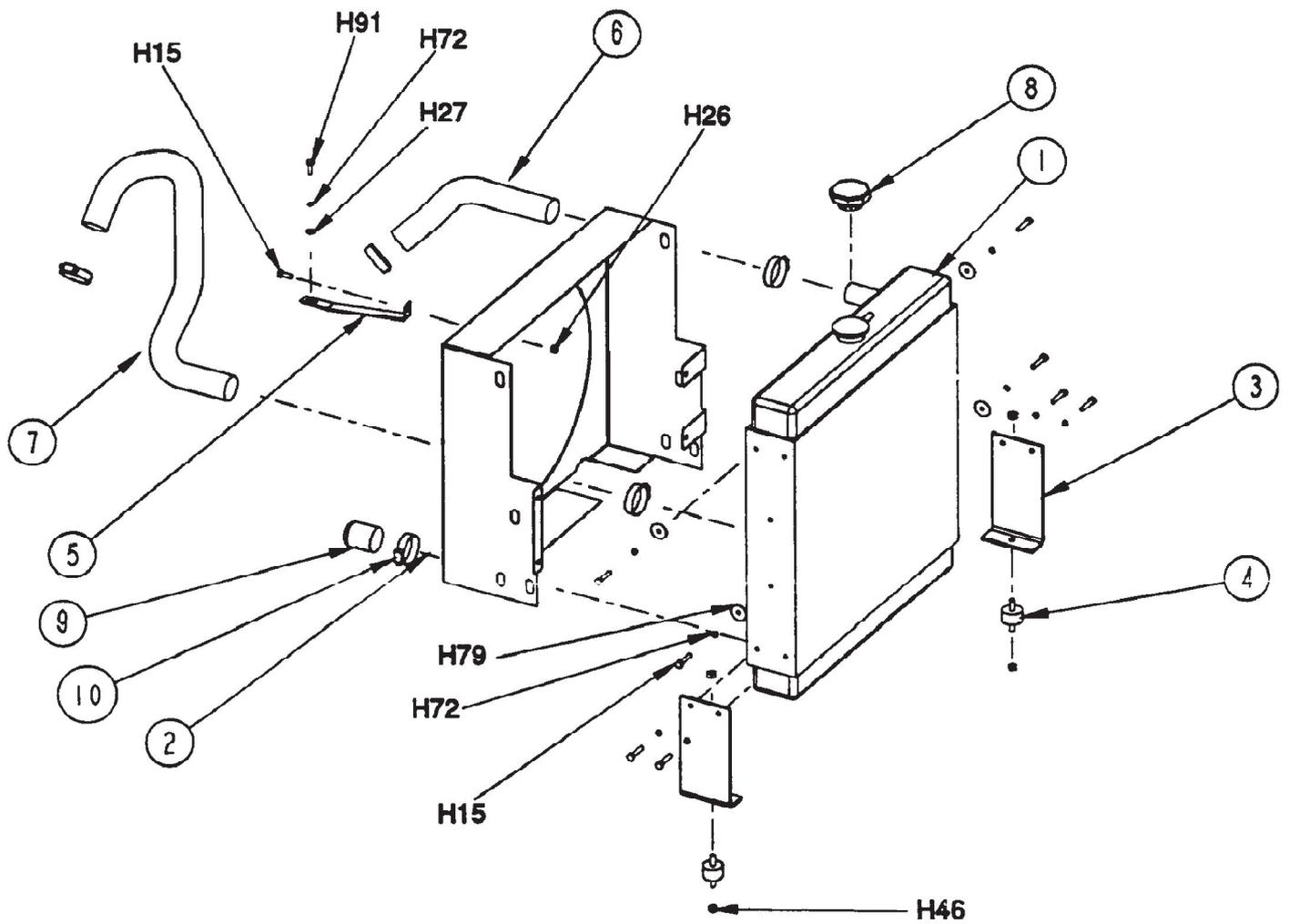

Referenznummer	Artikelnummer	Menge	Description
1	8-62-01011	1	Radiator, Four Core
2	8-72-00009	1	Radiator Shroud
2	8-72-00010	1	Radiator Shroud (Deisel) USED ON DIESEL MACHINES ONLY
3	8-08-00785	2	Mounting Bracket, Radiator
3	8-08-00805	2	Mounting Bracket, Radiator (Deisel) USED ON DIESEL MACHINES ONLY
4	8-50-05059	2	Pad, Radiator Mount
5	8-08-00784	1	Radiator Support Bracket
5	8-08-00824	1	Radiator Support Bracket (Deisel) USED ON DIESEL MACHINES ONLY
6	8-33-02317	1	Hose, Upper Radiator
6	8-33-02255	1	Hose, Upper Radiator (Deisel) USED ON DIESEL MACHINES ONLY
7	8-33-02318	1	Hose, Lower Radiator
7	7-33-02300	1	Hose, Lower Radiator (Deisel) USED ON DIESEL MACHINES ONLY
8	8-11-00045	1	Cap, Top
9	2-00-04913	1	Cap, Bottom Port
10	2-00-03404	5	Clamp
H15	2-00-00221	9	Screw, 1/4-20 x .750 HHC
H26	2-00-00641	1	Nut, 1/4-20 Insert Fiber
H27	2-00-03702	1	Washer, .625 x .281 x .063
H46	2-00-00644	4	Nut, 5/16-18, Insert Fiber
H72	2-00-00518	9	Lock Washer, Helical Spring
H79	2-00-01676	4	Flat Washer, 1.062 x .265 x .062
H91	2-00-05279	1	Screw, M6 x 1.0 x 20 mm MHHC

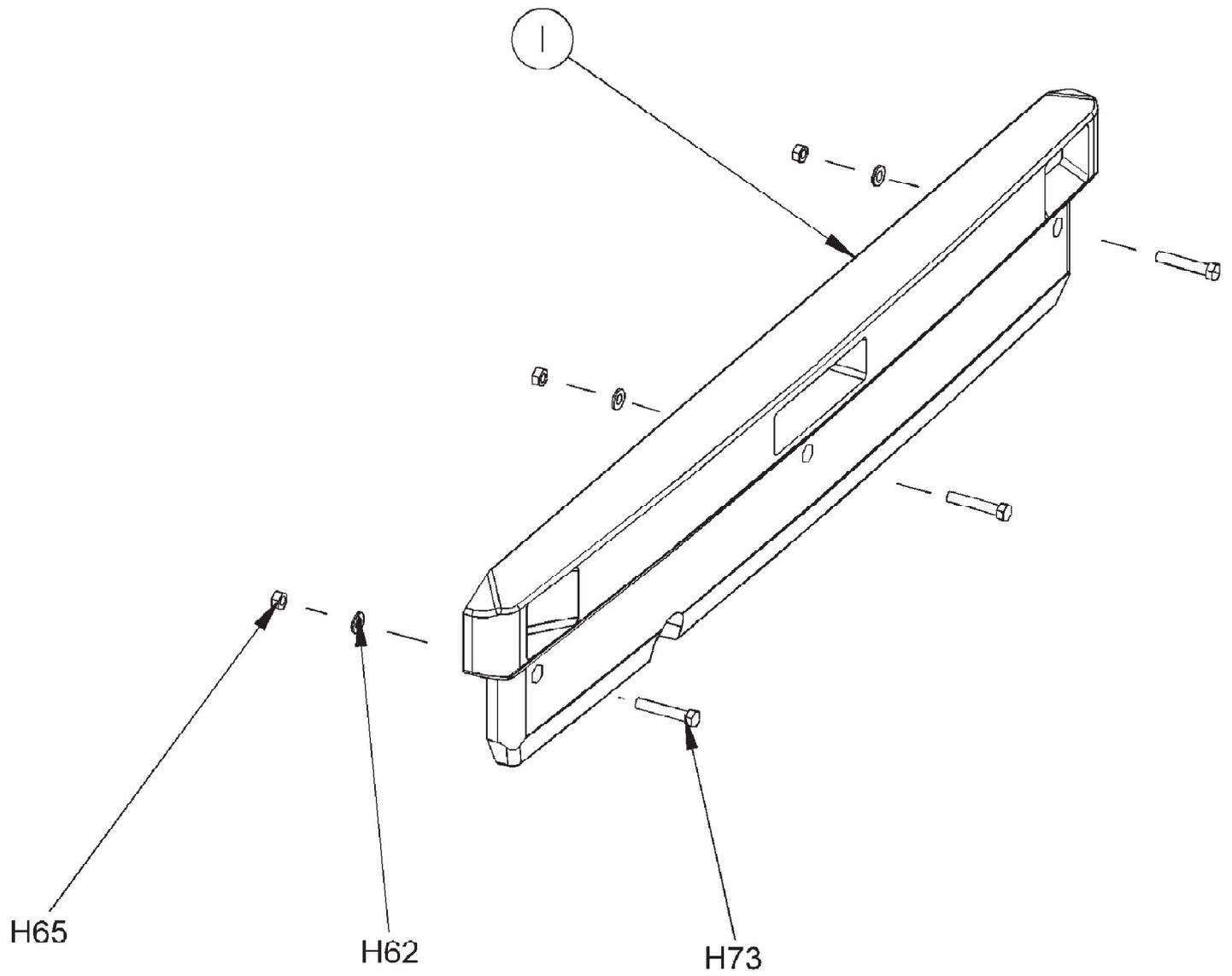

Referenznummer	Artikelnummer	Menge	Description
1	8-08-07056	1	Rear Bumper
H62	2-00-00405	3	Flat Washer, 1.063 x .531 x .094
H65	2-00-04936	3	Nut, 1/2-13 Fibre Lock
H73	2-00-00247	3	Screw, 1/2-13 x 2.500 HHC

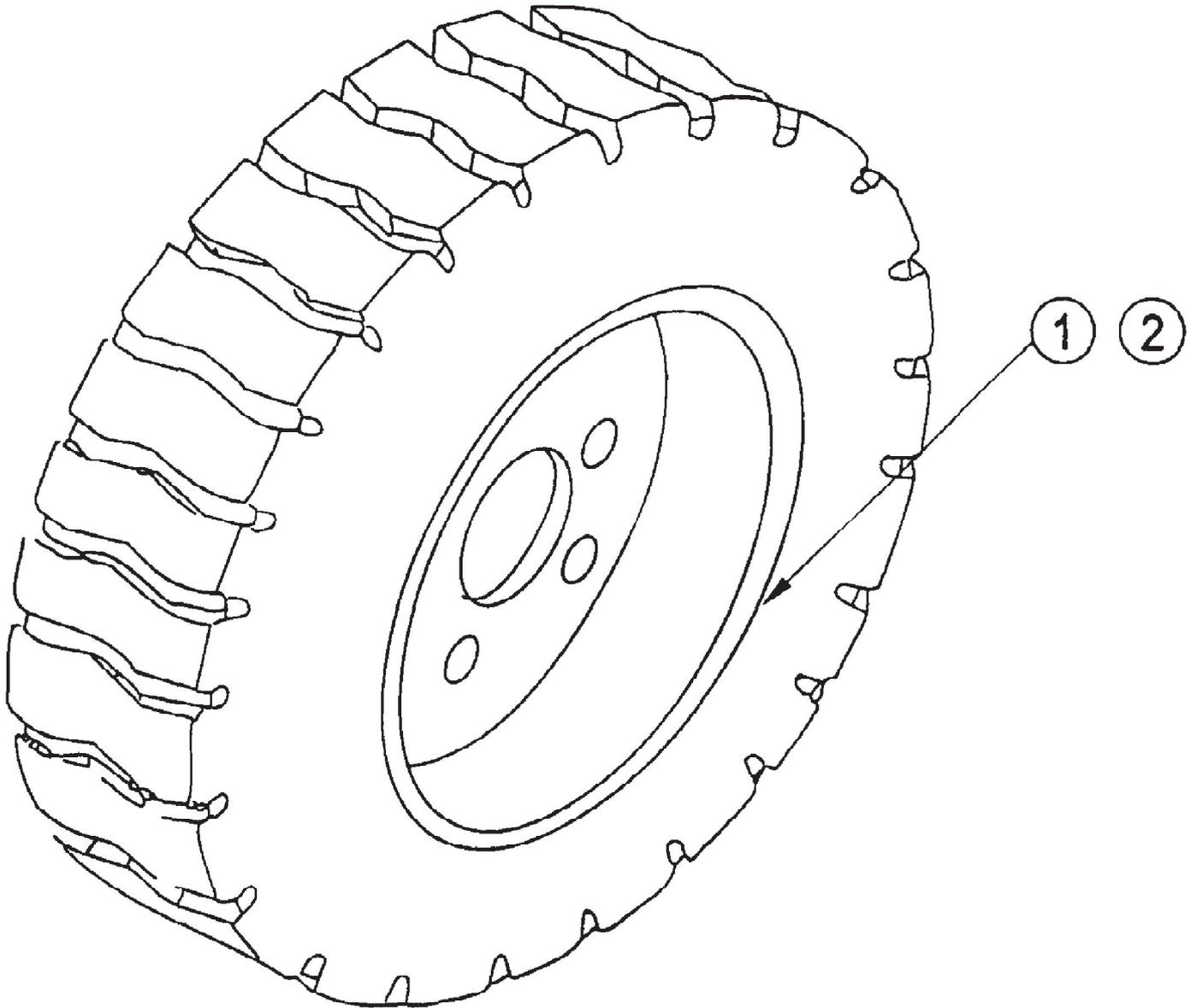

Referenznummer	Artikelnummer	Menge	Description
	0880-610		Rear Solid Cushion Tire Option
1	8-89-08070	1	Wheel Assembly, Soft Shoe Demountable
2	8-85-06018	Ref.	Tire, Soft Shoe

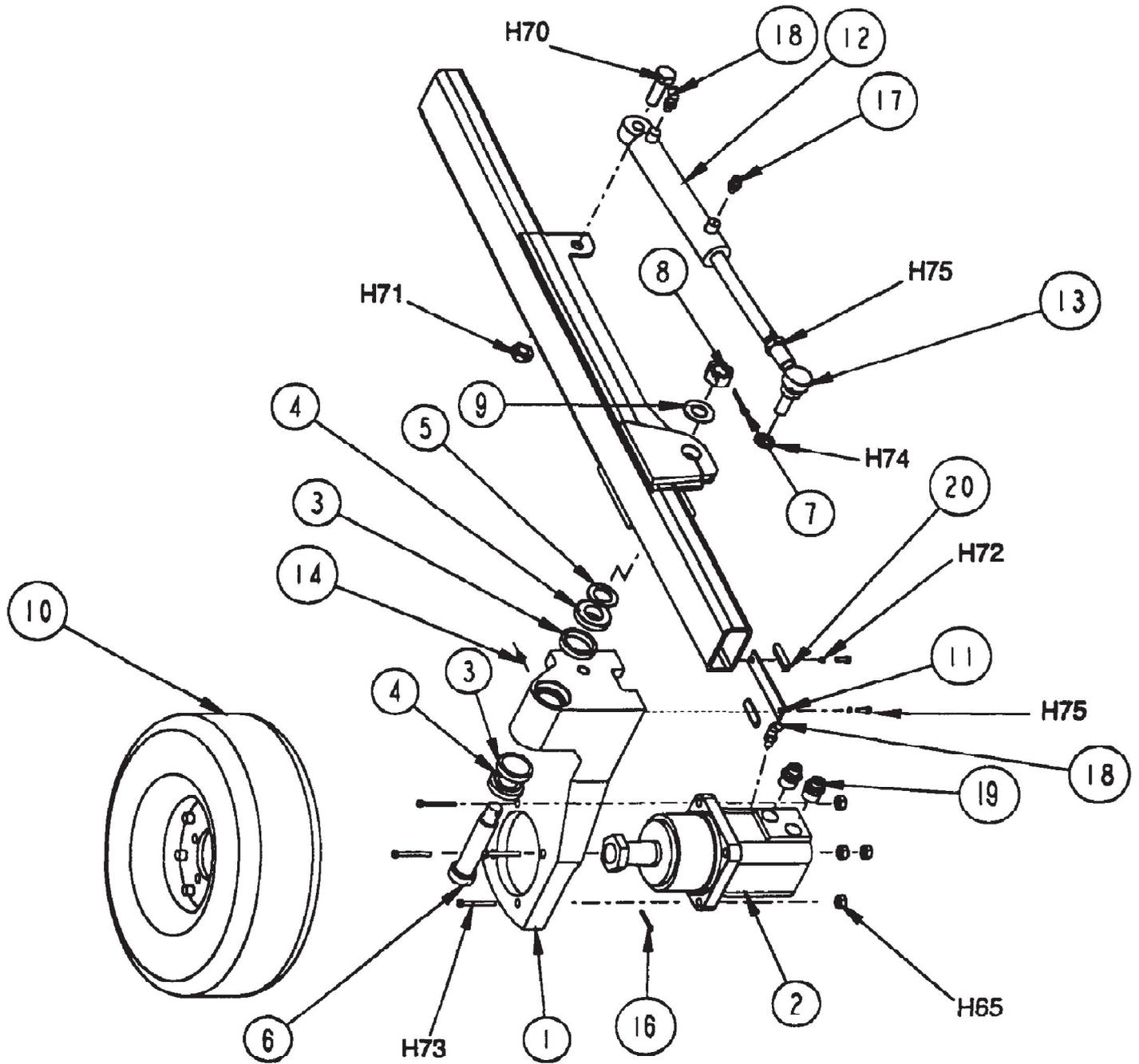

Referenznummer	Artikelnummer	Menge	Description
1	8-92-00040	1	Yoke, Rear Wheel
2	0885-083	1	Hydraulic Motor, 4000 Series
	0880-237		Hydraulic Motor Seal Kit Service Part
3	2-00-04621	2	Bearing, Outer Race Cup Only
4	2-00-04622	2	Bearing, Roller
5	8-75-01136	1	Flat Washer
6	8-55-08117	1	Pivot Pin, Rear Wheel
7	2-00-02436	1	Cotter Pin
8	2-00-05026	1	Nut, Slotted Hex 1-14 UNF
9	2-95-01977	1	Flat Washer
10	8-89-08068	1	Wheel Assembly
	8-85-06021		Tire Service Part
	8-70-00085		Tube Service Part
	7-70-00021		Hydraulic Cylinder Seal Kit Service Part
	0880-238		Shaft Seal Kit Service Part
11	8-65-00045	1	Retainer, Hydraulic Hose
12	7-17-05017	1	Hydraulic Cylinder
13	8-66-00149	1	Rod End
14	2-00-00566	1	Grease Zerk
15			UNKNOWN
16	2-00-00776	1	Cotter Pin, .12 diameter
17	2-00-04895	1	Fitting, Straight
18	2-00-04976	2	Fitting, 45°
19	2-00-04979	2	Fitting, Straight
20	8-21-04033	2	Edging
H15	2-00-00221	2	Screw, 1/4-20 x .750 HHC
H65	2-00-04936	4	Nut, 1/2-13 Fibre Lock
H70	2-00-05254	1	Screw, 3/4-10 x 2.250 HHC
H71	2-00-05255	1	Nut, 3/4-10 Nylon Lock
H72	2-00-00518	2	Lock Washer, Helical Spring
H73	2-00-00247	4	Screw, 1/2-13 x 2.500 HHC
H74	2-00-03170	1	Flat Washer, 1.500 x .750 x .125
H75	2-00-00618	1	Nut, Hex Jam 3/8-16

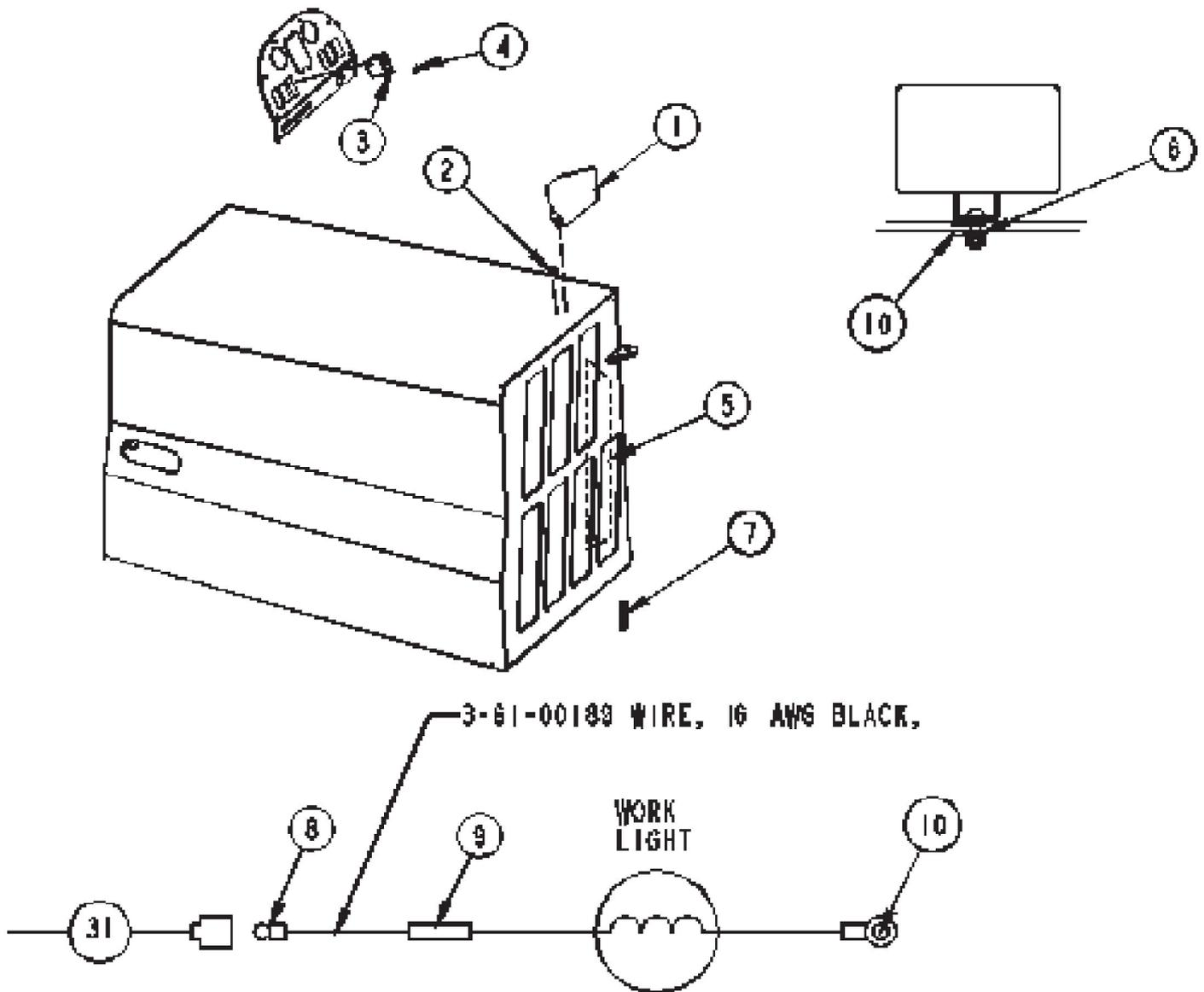

Referenznummer	Artikelnummer	Menge	Description
1	8-40-05049	1	Light
2	2-00-00491	2	Grommet
3	8-82-00053	1	Switch
4	8-41-03004	1	Lens, Work Light
5	8-20-06037	1	Duct, Wire
6	2-00-02303	1	Washer, Internal Lock
7	3-61-02014	1	Convolute Tube
8	2-00-05689	1	Terminal
9	2-00-01128	1	Butt Splice
10	2-00-04282	1	Ring Terminal
31		1	UNKNOWN

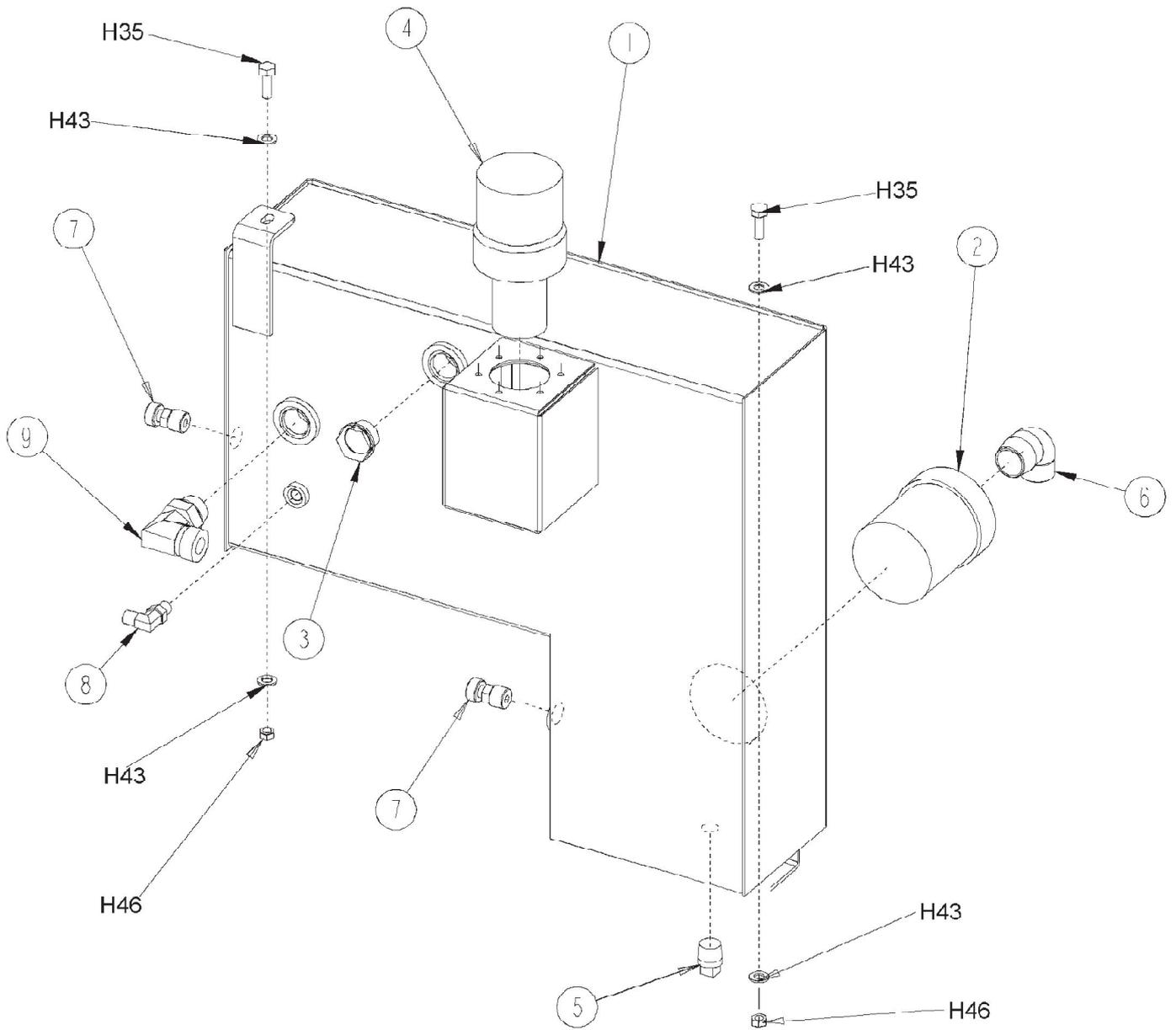

Referenznummer	Artikelnummer	Menge	Description
1	8-83-04039	1	Reservoir
2	8-24-04137	1	Strainer
3	8-48-05033	1	Sight Gauge
4	8-11-00026	1	Filler Cap Assembly
5	2-00-02474	1	Plug
6	2-00-05265	1	Fitting, 90° Street Ell
7	2-00-04970	2	Fitting, Connector
8	2-00-04892	1	Fitting, 90° Elbow
9	2-00-04972	1	Fitting, 90° Elbow
H35	2-00-02708	2	Screw, 5/16-18 x 1.000 HHM
H43	2-00-00409	4	Flat Washer, .687 x .344 x .062
H46	2-00-00644	2	Nut, 5/16-18, Insert Fiber

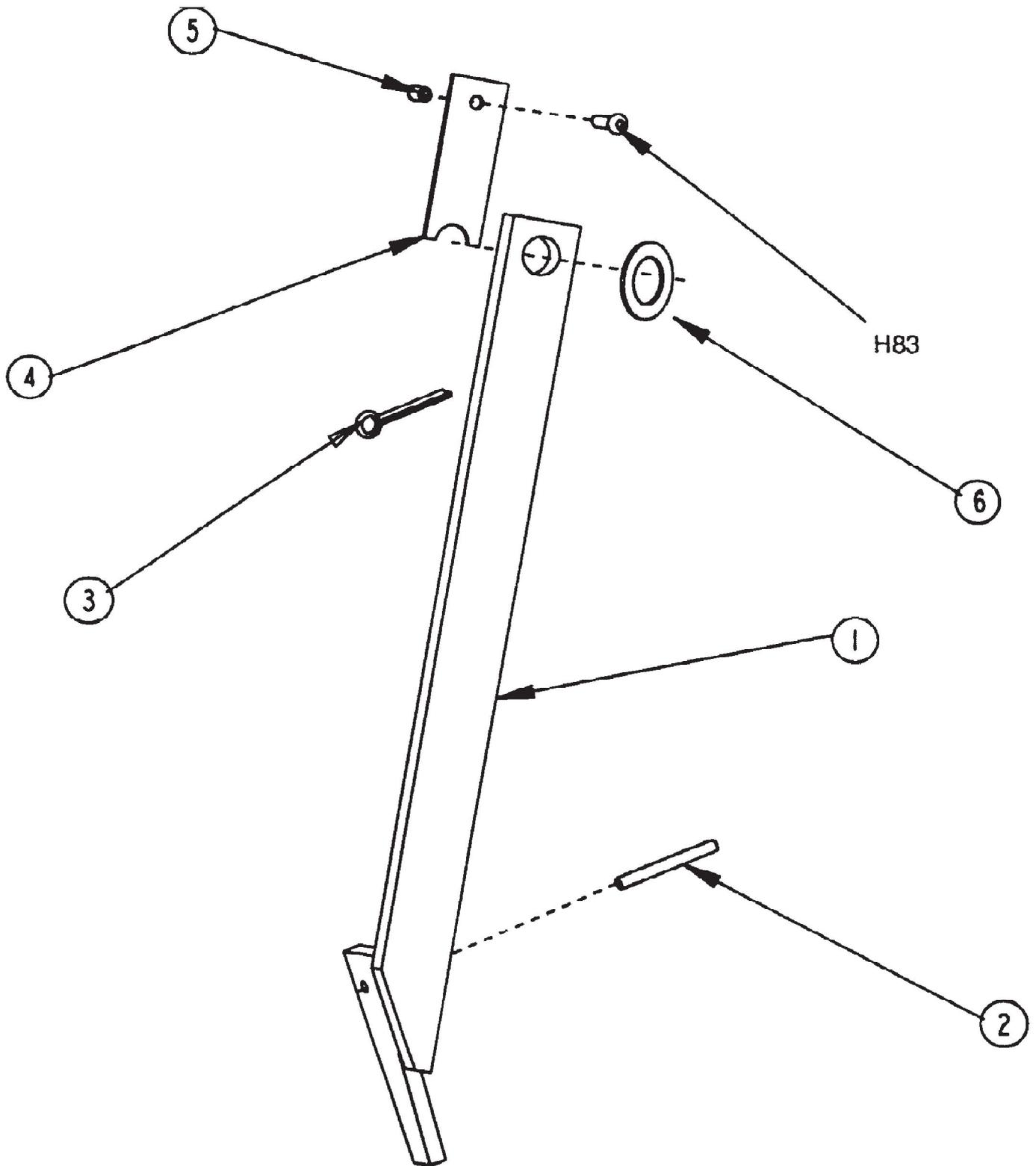

Referenznummer	Artikelnummer	Menge	Description
1	8-81-00168	1	Safety Arm Weldment
2	2-00-00868	1	Roll Pin, 1/4 Dia. x 2.250 Long
3	2-00-02436	1	Cotter Pin
4	8-71-00018	1	Shim
5	2-00-05261	1	Threaded Insert
6	2-00-00432	1	Flat Washer
H83	2-00-04877	1	Screw, 1/4-20 x 1.000 BHS

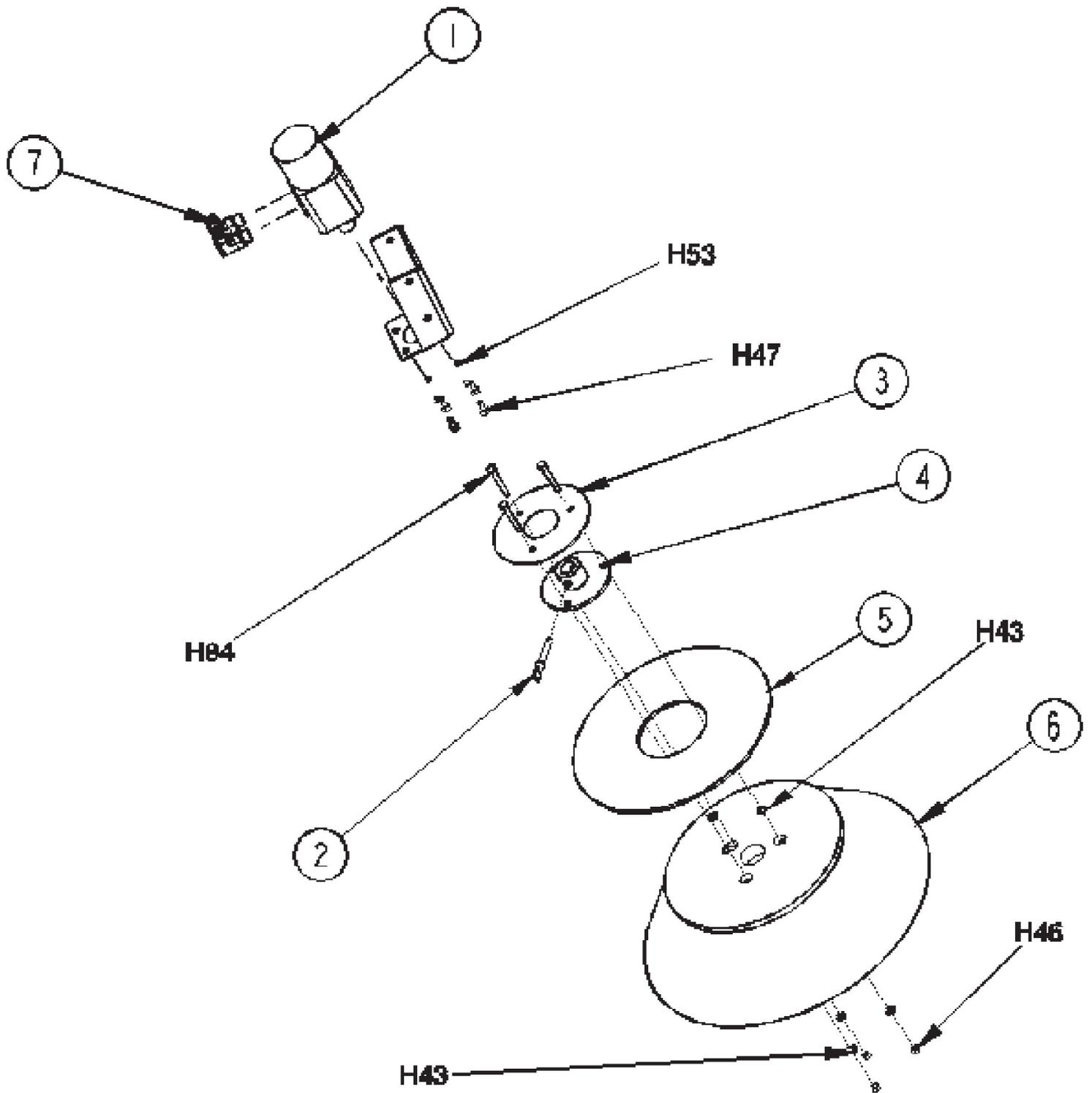

Referenznummer	Artikelnummer	Menge	Description
1	0882-050 0880-448	1	Side Broom Motor Side Broom Motor Seal Kit Service Part
2	8-55-08122	1	Pin, Side Broom Flange
3	8-25-06010	1	Flange, Roller Disc
4	8-33-09091	1	Hub Weldment
5	8-66-05011	1	Disc, Roller
6	8-08-03211	1	Side Broom, Nylon
7	2-00-04921	2	Fitting
H43	2-00-00409	6	Flat Washer, .687 x .344 x .062
H46	2-00-00644	3	Nut, 5/16-18, Insert Fiber
H47	2-00-00232	4	Screw, 3/8-16 x .750 HHC
H53	2-00-02310	4	Lock Washer, Helical Spring 3/8 Med.
H84	2-00-00228	3	Screw, 5/16-18 x 2.250 HHC

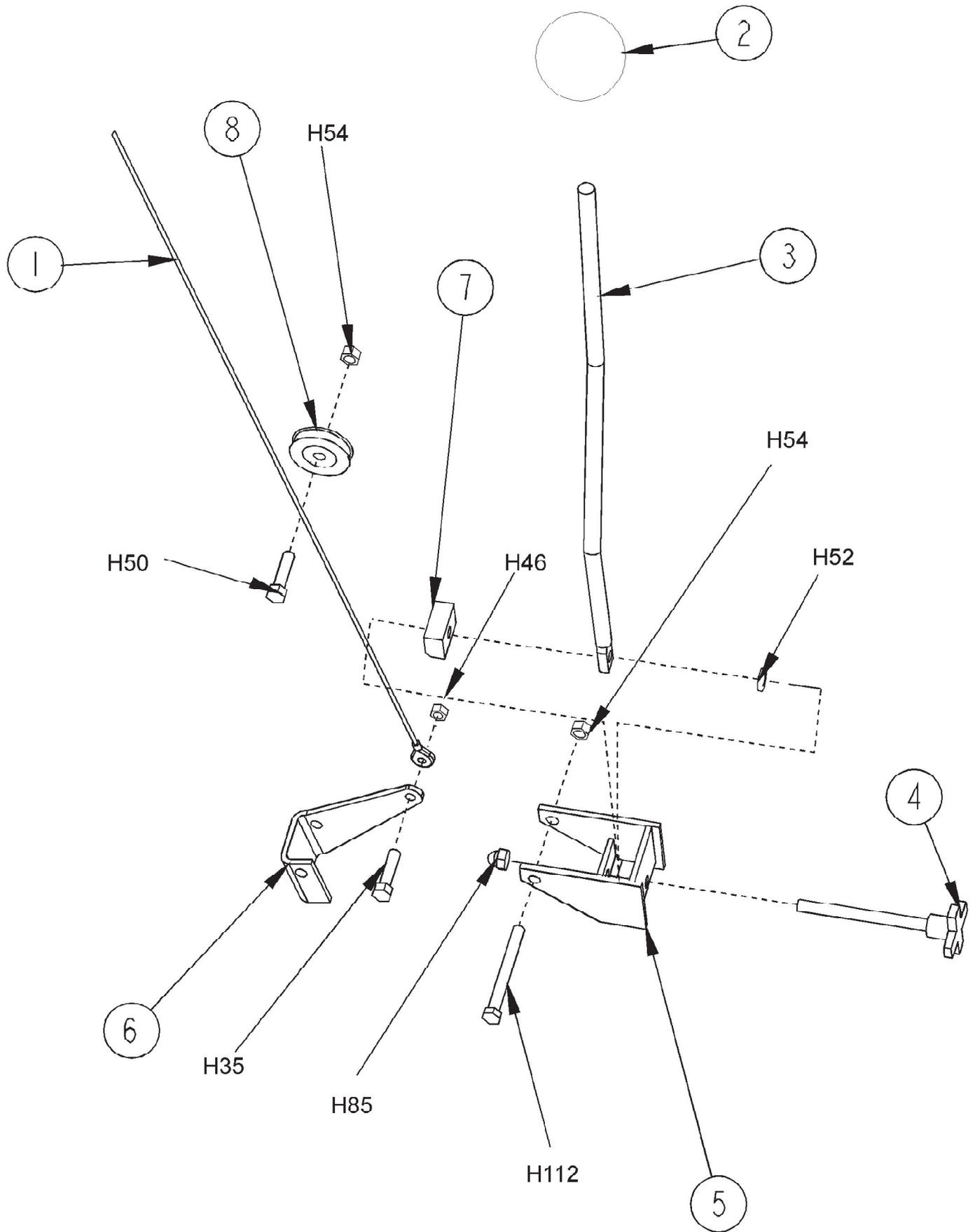

Referenznummer	Artikelnummer	Menge	Description
1	8-10-00039	1	Cable
2	8-39-00003	1	Control Knob, Small
3	8-66-00167	1	Lever Handle
4	8-39-00013	1	Knob Assembly
5	8-08-00773	1	Broom Lift, Main Broom/Side Broom Weldment
6	8-08-00775	1	Bracket, Angle Adjustment
7	8-50-03002	1	Broom Adjustment Block
8	7-60-00160	1	Pulley, Cable
H35	2-00-02708	1	Screw, 5/16-18 x 1.000 HHM
H46	2-00-00644	1	Nut, 5/16-18, Insert Fiber
H50	2-00-00234	1	Screw, 3/8-16 x 1.500 HHC
H52	2-00-00402	1	Flat Washer, .750 x .390 x .094
H54	2-00-02360	2	Nut, 3/8-16 Hex.
H85	2-00-00650	1	Nut, Cap 3/8-16 Low Crown
H112	2-00-02603	1	Screw, 3/8-16 x 3.500 HHC

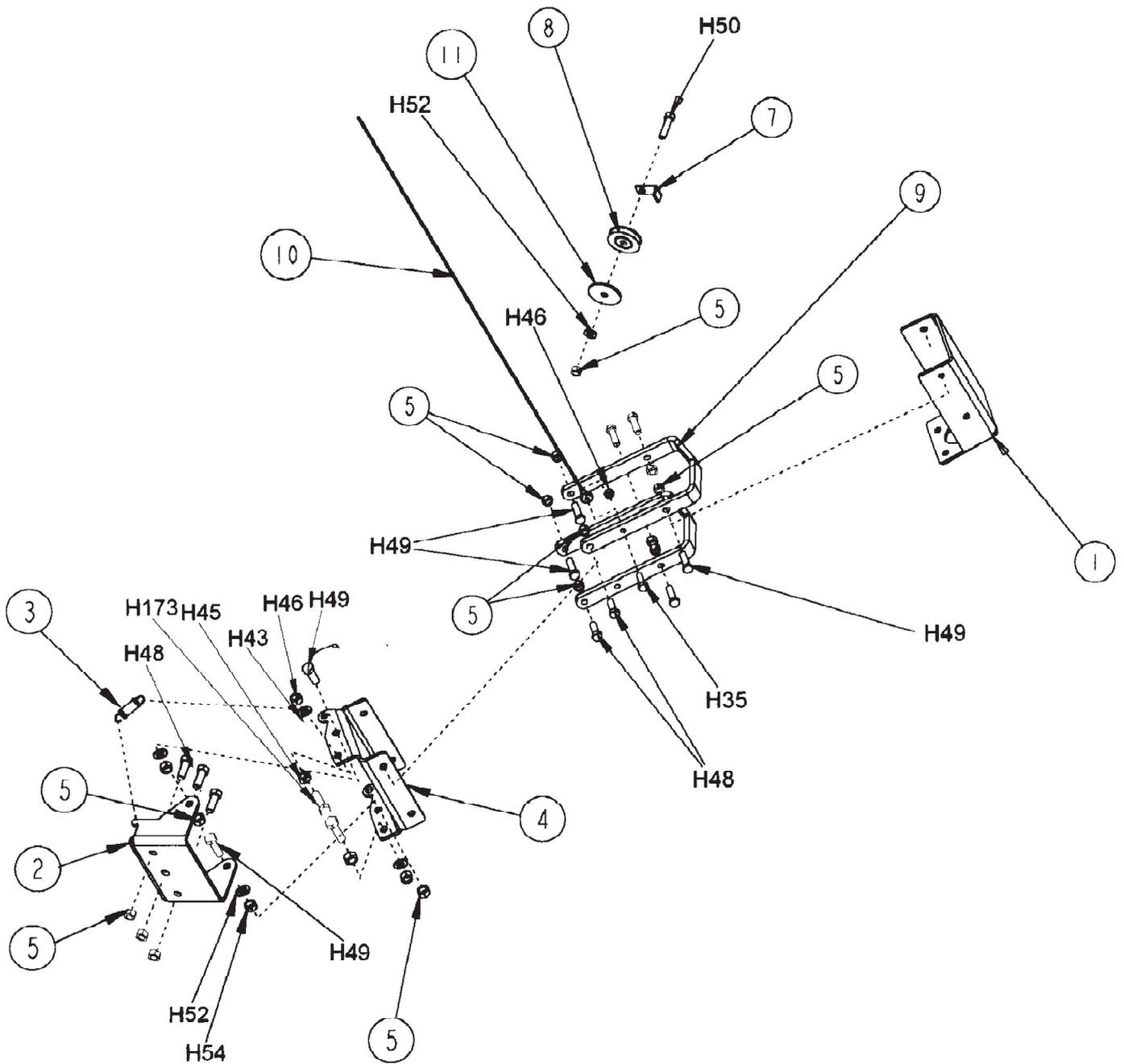

Referenznummer	Artikelnummer	Menge	Description
1	8-08-00772	1	Bracket, Side Broom
2	8-08-00790	1	Bracket
3	7-76-00101	2	Spring
4	8-08-00846	1	Pivot Bracket
5	2-95-04182	14	Nut, Elastic Stop
7	7-13-07130	1	Clip, Cable Retainer
8	7-60-00160	1	Pulley, Cable
9	8-42-05136	2	Side Broom Link
10	8-10-00039	1	Cable
11	2-95-04689	1	Flat Washer
H35	2-00-02708	1	Screw, 5/16-18 x 1.000 HHM Hardware
H43	2-00-00409	2	Flat Washer, .687 x .344 x .062 Hardware
H45	2-00-00585	2	Nut, Hex. 5/16-18 x .500 x .265 Hardware
H46	2-00-00644	3	Nut, 5/16-18, Insert Fiber Hardware
H48	2-00-00233	5	Screw, 3/8-16 x 1.000 HHC Hardware
H49	2-00-00209	8	Screw, 3/8-16 x 1.250 HHC Hardware
H50	2-00-00234	1	Screw, 3/8-16 x 1.500 HHC Hardware
H52	2-00-00402	3	Flat Washer, .750 x .390 x .094 Hardware
H54	2-00-02360	2	Nut, 3/8-16 Hex. Hardware
H173	2-00-02709	2	Screw, 5/16-18 x 1.500 Hardware

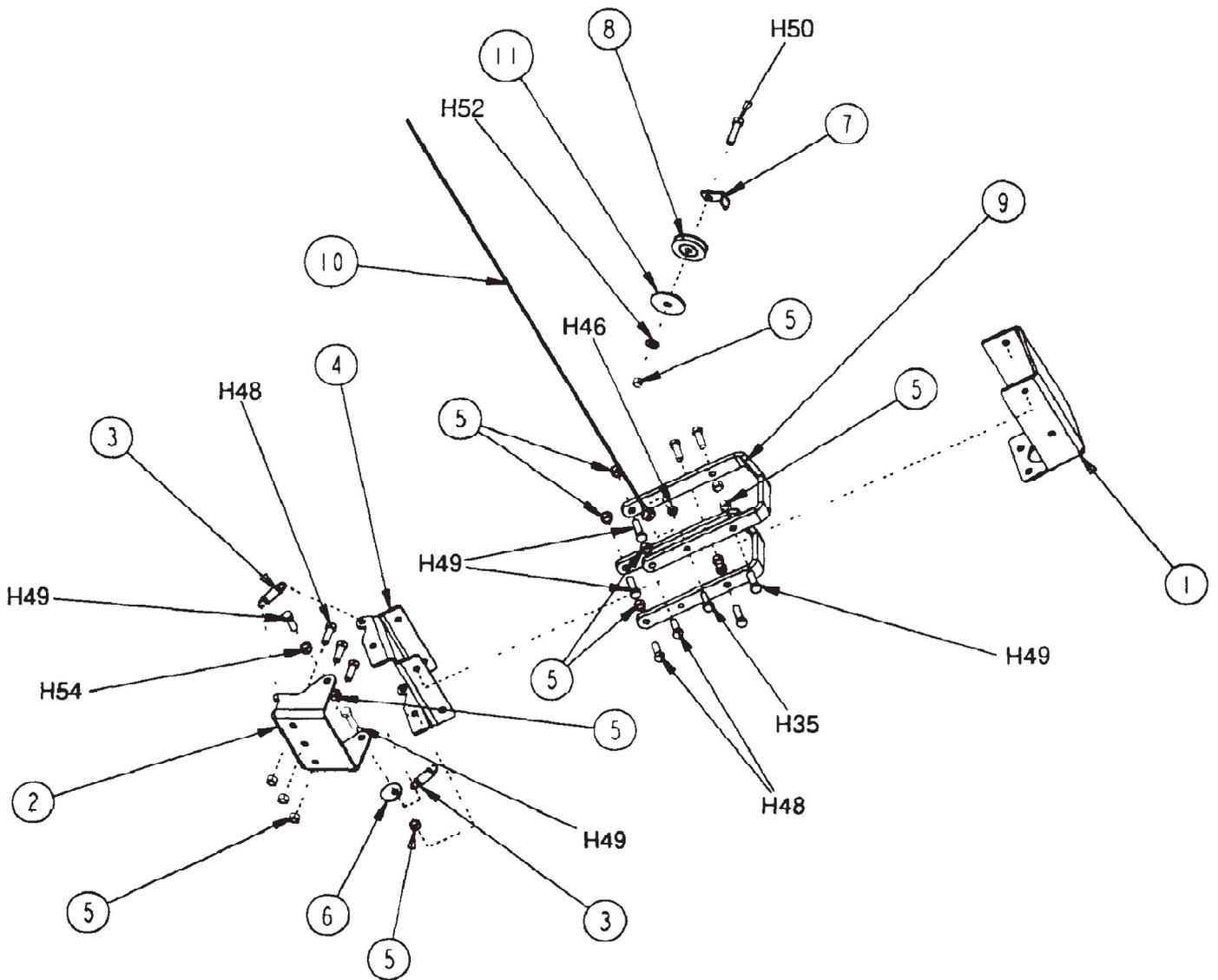

Referenznummer	Artikelnummer	Menge	Description
1	8-08-00772	1	Bracket, Side Broom
2	8-08-00790	1	Bracket
3	7-76-00101	2	Spring
4	8-08-00789	1	Pivot Bracket
5	2-95-04182	14	Nut, Elastic Stop
6	8-78-05022	1	Cam Stop, Side Broom
7	7-13-07130	1	Clip, Cable Retainer
8	7-60-00160	2	Pulley, Cable
9	8-41-05136	2	Side Broom Link
10	8-10-00039	1	Cable
11	2-95-04689	1	Flat Washer
H35	2-00-02708	1	Screw, 5/16-18 x 1.000 HHM
H46	2-00-00644	1	Nut, 5/16-18, Insert Fiber
H48	2-00-00233	6	Screw, 3/8-16 x 1.000 HHC
H49	2-00-00209	5	Screw, 3/8-16 x 1.250 HHC
H50	2-00-00234	1	Screw, 3/8-16 x 1.500 HHC
H52	2-00-00402	1	Flat Washer, .750 x .390 x .094
H54	2-00-02360	1	Nut, 3/8-16 Hex.

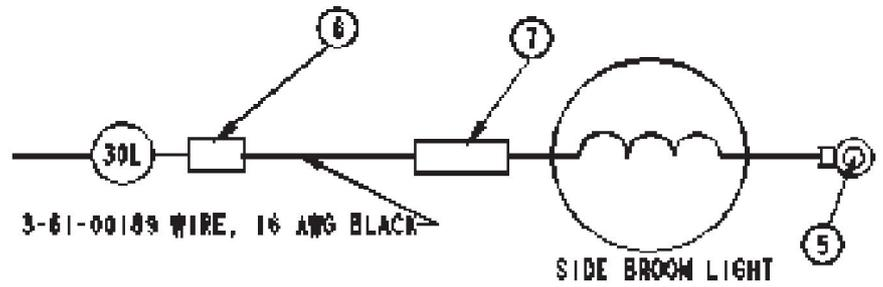
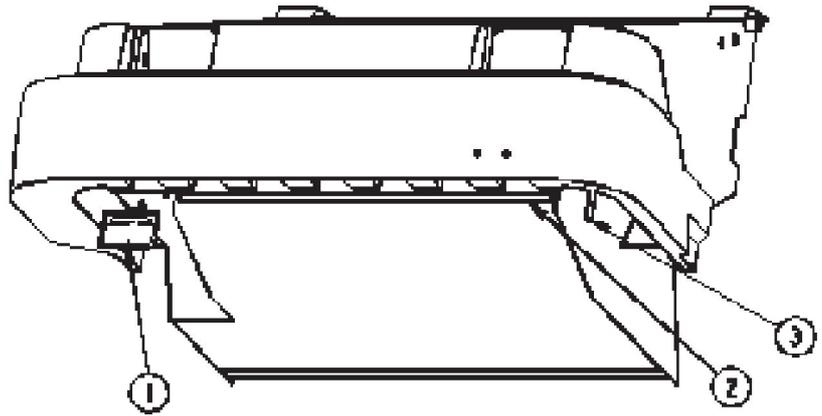
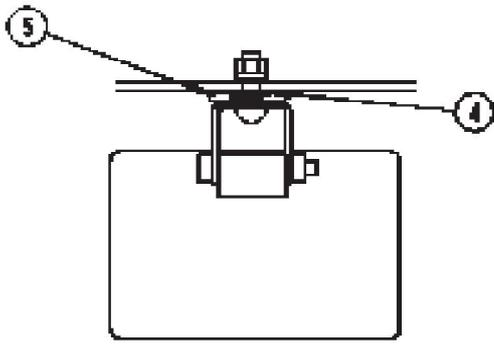

Referenznummer	Artikelnummer	Menge	Description
1	8-40-05049	1	Light
2	8-20-06038	1	Duct, Wire
3	8-20-06037	1	Duct, Wire
4	2-00-02303	1	Washer, Internal Lock
5	2-00-04282	1	Ring Terminal
6	2-00-04578	1	Terminal
7	2-00-01128	1	Butt Splice

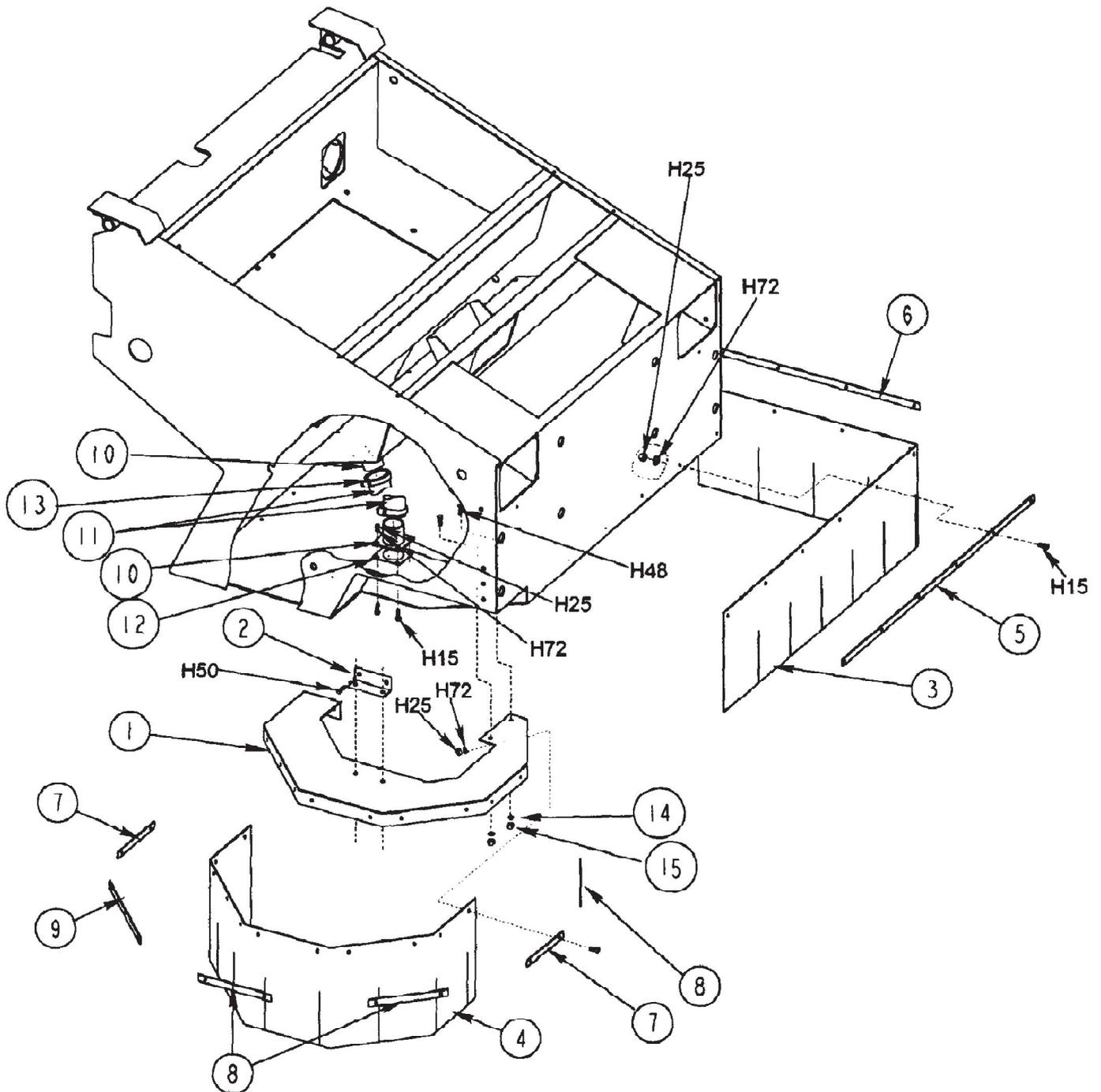

Referenznummer	Artikelnummer	Menge	Description
1	8-33-05132	1	Broom Guard
2	8-08-00864	1	Bracket, Broom Guard
3	8-25-08216	1	Flap
4	8-25-08217	1	Flap
5	8-13-07155	1	Clamp
6	8-13-07156	1	Clamp
7	8-13-07157	2	Clamp
8	8-13-07158	3	Clamp
9	8-13-07159	1	Clamp
10	8-03-02043	2	Hose Adapter
11	8-33-02346	1	Hose
12	8-29-00253	2	Gasket
13	2-00-02217	2	Clamp, Hose
14	2-00-02310	8	Lockwasher Split .375 Cad. Pl.
15	2-00-02360	8	Nut, Hex .375-16
H15	2-00-00221	31	Screw, 1/4-20 x .750 HHC Hardware
H25	2-00-00594	31	Nut, Hex 1/4-20 x .437 x .218 Hardware
H48	2-00-00233	6	Screw, 3/8-16 x 1.000 HHC Hardware
H50	2-00-00234	2	Screw, 3/8-16 x 1.500 HHC Hardware
H72	2-00-00518	31	Lock Washer, Helical Spring Hardware

8-25-08195	Flap, Broom Door Outer
8-25-08198	Flap, Broom Door Inner
8-25-08194	Flap, Wheel Well
8-25-08197	Flap, Rear Inside Frame
8-25-08196	Flap, Frame Rear Outside
8-24-04139	Hopper Panel Filter
8-25-08202	Hopper Flap
8-68-05075	Seal, Dump Door - Sides
8-68-05077	Seal, Dump Door - Lip
8-24-04016	Engine Air Cleaner Element
2-00-05248	V-Belt, Alternator
8-24-04138	Fuel Filter
8-24-04099	Engine Oil Filter
8-24-04118	Hydraulic Filter Element
8-68-05076	Seal, Dump Door Foam

Referenznummer	Artikelnummer	Menge	Description
8-25-08195	8-25-08195	2	Flap, Broom Door Outer
8-25-08198	8-25-08198	2	Flap, Broom Door Inner
8-25-08194	8-25-08194	1	Flap, Wheel Well
8-25-08197	8-25-08197	1	Flap, Rear Inside Frame
8-25-08196	8-25-08196	1	Flap, Frame Rear Outside
8-24-04139	8-24-04139	1	Hopper Panel Filter
8-25-08202	8-25-08202	1	Hopper Flap
8-68-05075	8-68-05075	2	Seal, Dump Door-Sides
8-68-05077	8-68-05077	1	Seal, Dump Door-Lip
8-24-04016	8-24-04016	1	Engine Air Cleaner Element
2-00-05248	2-00-05248	1	V-Belt, Alternator
8-24-04138	8-24-04138	1	Fuel Filter
8-24-04099	8-24-04099	1	Engine Oil Filter
8-24-04118	8-24-04118	1	Hydraulic Filter Element
8-68-05076	8-68-05076	1	Seal, Dump Door Foam

No Artwork Available

**Press (F11) for further
information**

Referenznummer	Artikelnummer	Menge	Description
1	8-25-08195	2	Flap, Broom Door Outer
2	8-25-08198	2	Flap, Broom Door Inner
3	8-25-08194	1	Flap, Wheel Well
4	8-25-08197	1	Flap, Rear Inside Frame
5	8-25-08196	1	Flap, Frame Rear Outside
6	8-24-04139-1	1	Hopper Panel Filter
7	8-25-08202	1	Hopper Flap
8	8-68-05075	2	Seal, Dump Door - Sides
9	8-68-05077	1	Seal, Dump Door - Lip
10	8-24-04106	1	Engine Air Cleaner Element
11	2-60-02242	1	Belt, Alternator
12	2-60-02241	1	Fuel Filter
13	2-60-02240	1	Engine Oil Filter
14	8-24-04118	1	Hydraulic Filter Element
15	8-68-05076	1	Seal, Dump Door - Foam

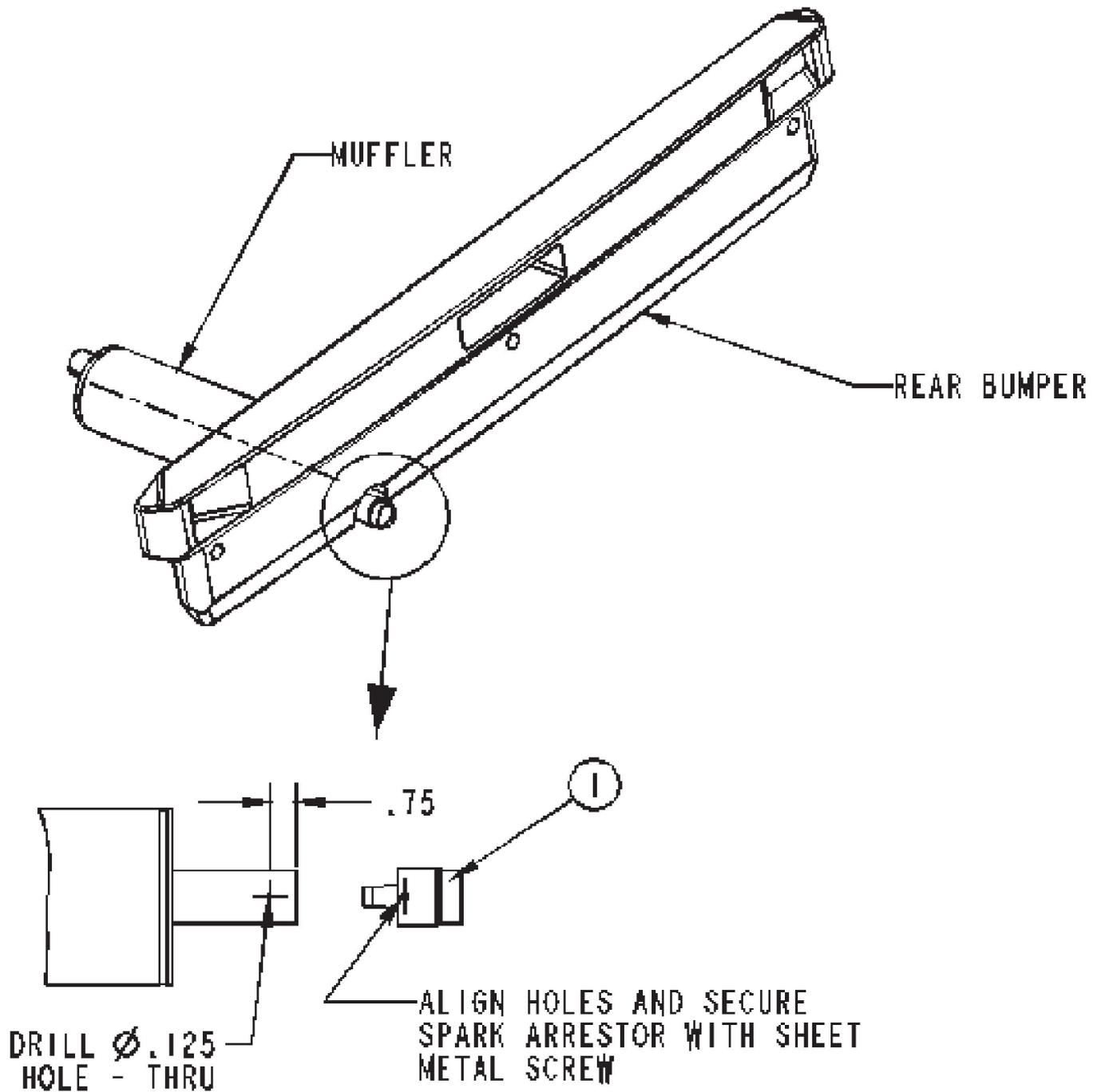

Referenznummer	Artikelnummer	Menge	Description
	0880-608		Spark Arrestor Option
1	8-81-05001	1	Spark Arrestor

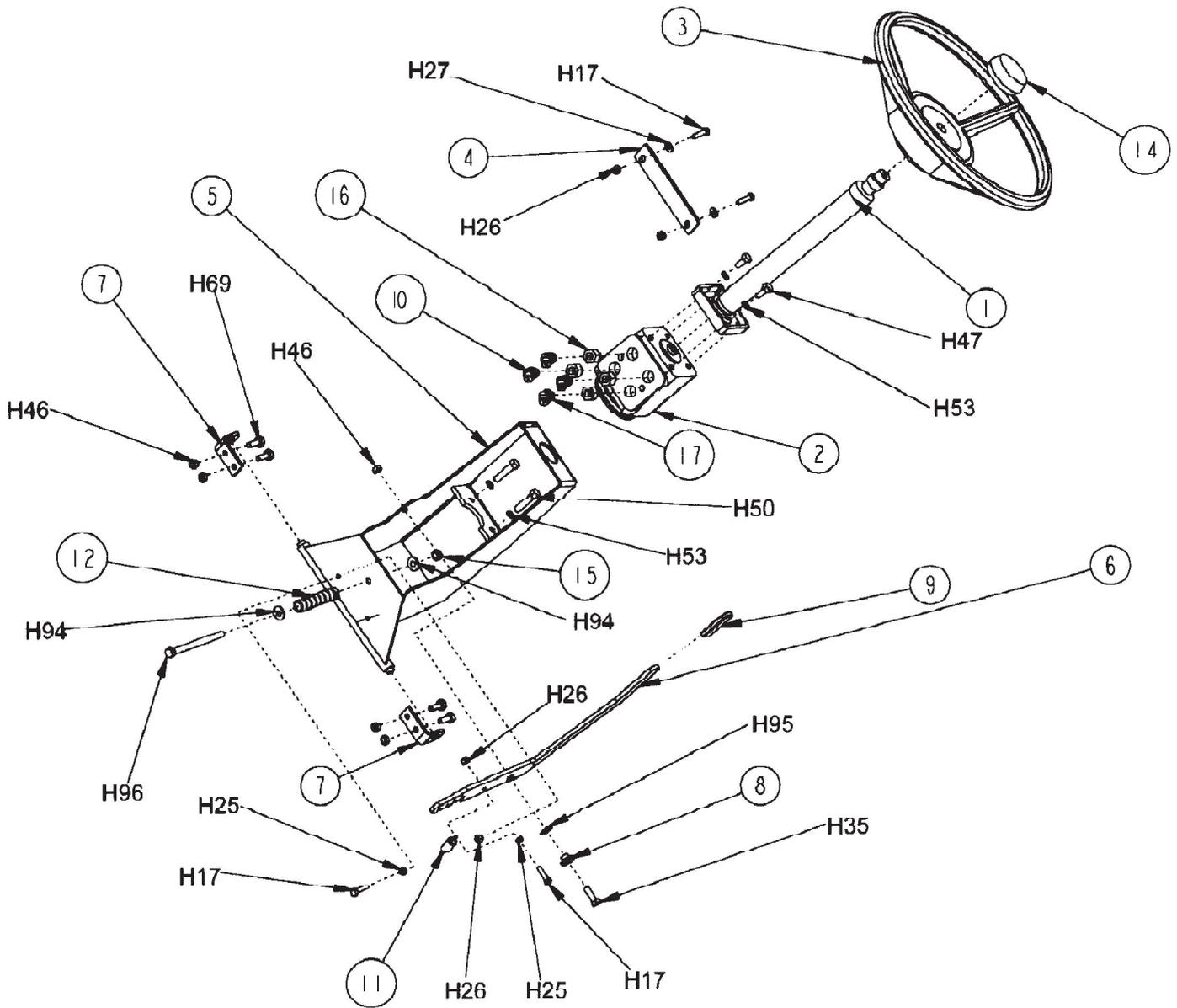

Referenznummer	Artikelnummer	Menge	Description
1	8-70-05303	1	Steering Column
2	8-60-05026	1	Steering Control Unit
	0880-675		Steering Control Unit Seal Kit (Service Part)
3	7-89-08041	1	Steering Wheel
4	8-58-05270	1	Plate, Latch
5	8-33-05117	1	Steering, Housing
6	8-41-00050	1	Latch, Tilt Steering
7	8-08-00780	2	Housing, Mounting Bracket
8	7-09-01057	1	Bushing
9	8-31-06083	1	Grip, Latch
10	2-00-05315	2	Fitting, 45°
11	8-76-00042	1	Spring, Tension
12	2-10-01336	1	Spring, Compression
14	8-11-00022	1	Cap
15	2-95-04182	1	Stop Nut, Elastic
16	2-00-04932	4	Fitting, Reducer
17	2-00-05340	2	Fitting, 45°
H17	2-00-00205	4	Screw, 1/4-20 x 1.000 HHC Hardware
H25	2-00-00594	2	Nut, Hex 1/4-20 x .437 x .218 Hardware
H26	2-00-00641	4	Nut, 1/4-20 Insert Fiber Hardware
H27	2-00-03702	2	Washer, .625 x .281 x .063 Hardware
H35	2-00-02708	1	Screw, 5/16-18 x 1.000 HHM Hardware
H46	2-00-00644	5	Nut, 5/16-18, Insert Fiber Hardware
H47	2-00-00232	2	Screw, 3/8-16 x .750 HHC Hardware
H50	2-00-00234	2	Screw, 3/8-16 x 1.500 HHC Hardware
H53	2-00-02310	4	Lock Washer, Helical Spring 3/8 Med. Hardware
H69	2-00-01255	4	Screw, 5/16-18 x .875 HHC Hardware
H94	2-00-00410	2	Flat Washer, .875 x .375 x .060 Hardware
H95	2-00-03382	1	Spring Washer, .875 x .500 x .015 Hardware
H96	2-00-02605	1	Screw, 3/8-16 x 4.500 HHC, Cadmium Plated Hardware

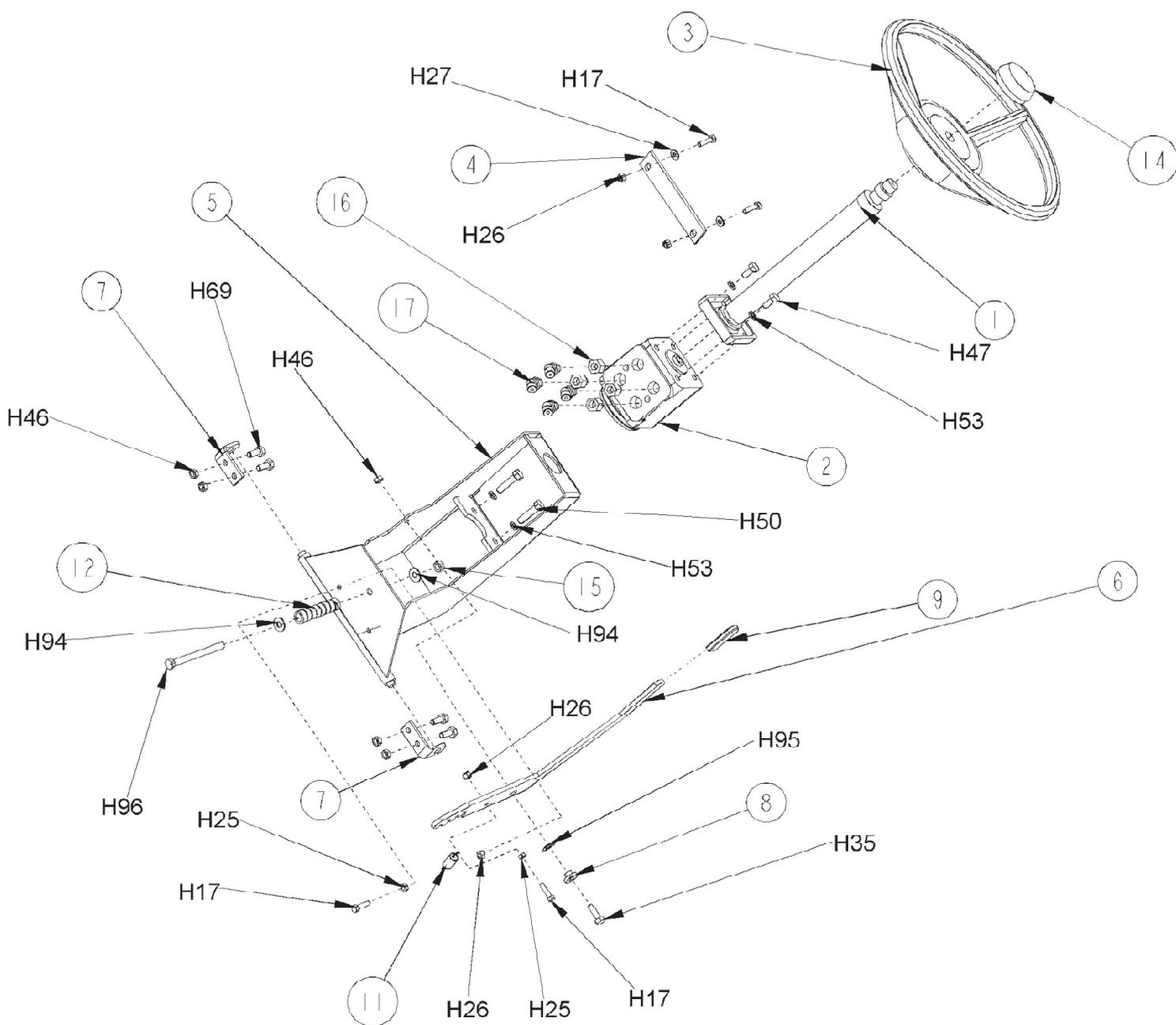

Referenznummer	Artikelnummer	Menge	Description
1	8-70-05303	1	Steering Column
2	7-60-05016	1	Steering Control Unit
	0880-534		Steering Control Unit Seal Kit (Service Part)
3	7-89-08041	1	Steering Wheel
4	8-58-05270	1	Plate, Latch
5	8-33-05117	1	Steering, Housing
6	8-41-00050	1	Latch, Tilt Steering
7	8-08-00780	2	Housing, Mounting Bracket
8	7-09-01057	1	Bushing
9	8-31-06083	1	Grip, Latch
11	8-76-00042	1	Spring, Tension
12	2-10-01336	1	Spring, Compression
14	8-11-00022	1	Cap
15	2-95-04182	1	Stop Nut, Elastic
16	2-00-04917	4	Fitting, Straight
17	2-00-04976	4	Fitting, 45°
H17	2-00-00205	4	Screw, 1/4-20 x 1.000 HHC
H25	2-00-00594	2	Nut, Hex 1/4-20 x .437 x .218
H26	2-00-00641	4	Nut, 1/4-20 Insert Fiber
H27	2-00-03702	2	Washer, .625 x .281 x .063
H35	2-00-02708	1	Screw, 5/16-18 x 1.000 HHM
H46	2-00-00644	5	Nut, 5/16-18, Insert Fiber
H47	2-00-00232	2	Screw, 3/8-16 x .750 HHC
H50	2-00-00234	2	Screw, 3/8-16 x 1.500 HHC
H53	2-00-02310	4	Lock Washer, Helical Spring 3/8 Med.
H69	2-00-01255	4	Screw, 5/16-18 x .875 HHC
H94	2-00-00410	2	Flat Washer, .875 x .375 x .060
H95	2-00-03382	1	Spring Washer, .875 x 500 x .015
H96	2-00-02605	1	Screw, 3/8-16 x 4.500 HHC, Cadium Plated

Referenznummer	Artikelnummer	Menge	Description
1	8-40-05036	1	Strobe, Amber
	8-40-05020	1	Strobe, Red
2	8-58-05228	1	Panel, Light Support
3	8-20-06036	1	Duct, Wire
4	2-00-01915	2	Grommet
5	2-00-05261	4	Threaded Insert
6	2-00-00491	1	Grommet
7	2-00-04281	1	Terminal
8	8-90-07434	1	Wing Wire
9	8-11-00015	2	Terminal
10	2-00-04578	2	Terminal
11	2-00-04626	1	Terminal
12	8-11-00044	1	Cap, Boot
13	8-64-00008	1	Circuit Breaker, 15 amp
14	2-00-04200	1	Grommet
H12	2-00-01246	2	Nut, Hex Fiber Insert #10-24 Hardware
H17	2-00-00205	4	Screw, 1/4-20 x 1.000 HHC Hardware
H72	2-00-00518	4	Lock Washer, Helical Spring Hardware
H115	2-00-03063	2	Screw, #10-24 x .750 THM Hardware

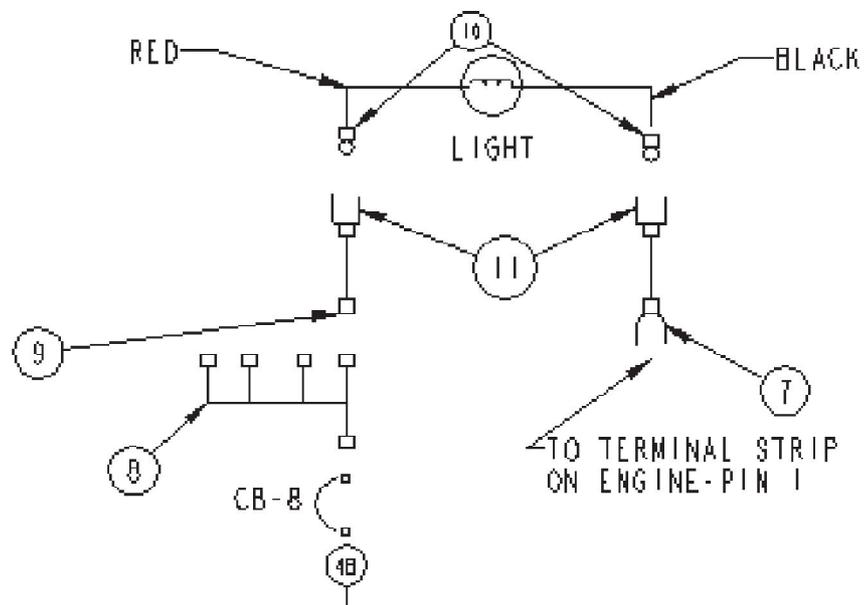
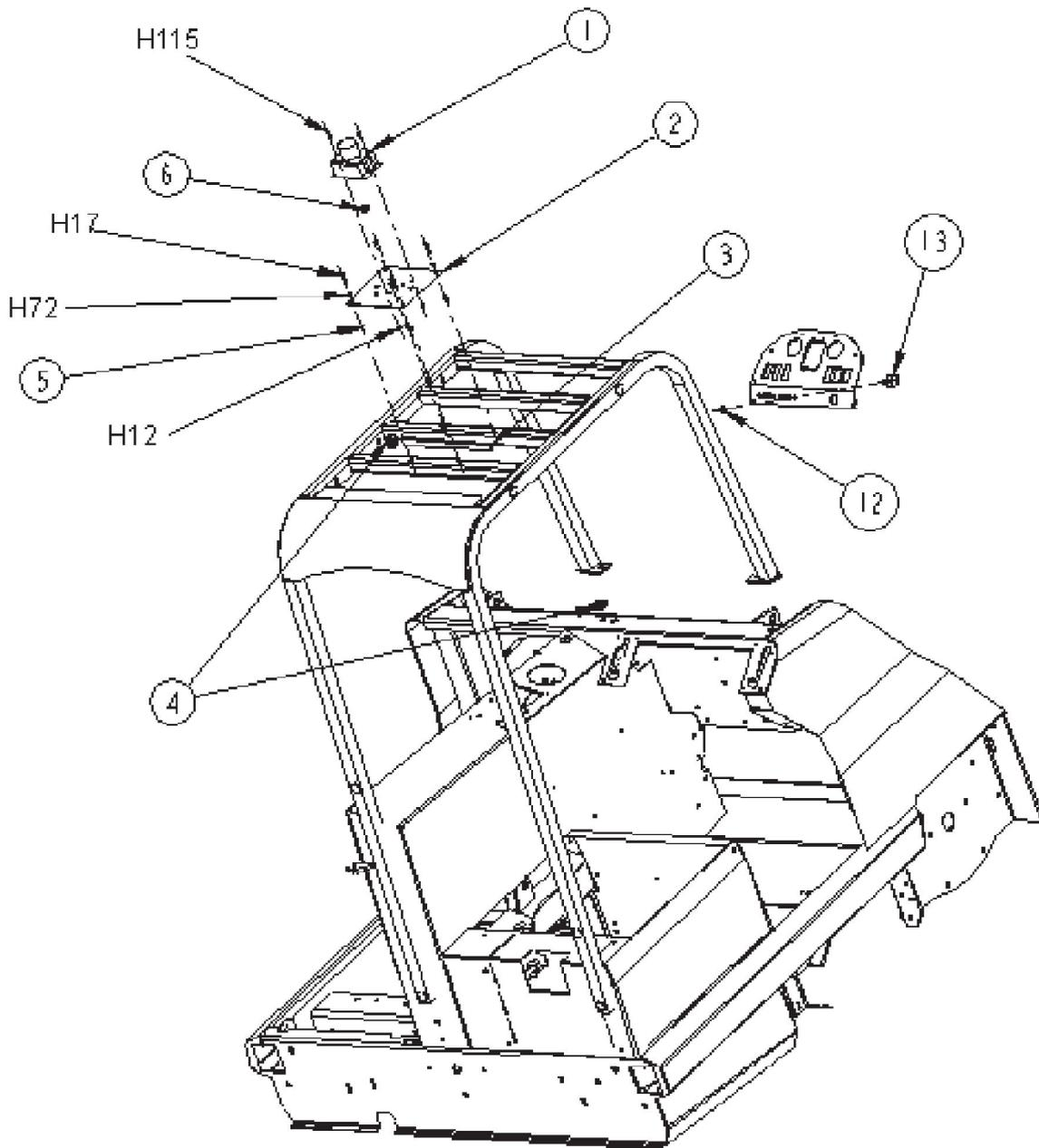

Referenznummer	Artikelnummer	Menge	Description
	0880-600		Amber Strobe Option
	0880-599		Red Strobe Option
1	8-40-05036	1	Strobe, Amber
	8-40-05020	1	Strobe, Red
2	8-58-05228	1	Panel, Light Support
3	8-20-06036	2	Duct, Wire
4	2-00-01915	4	Grommet
5	2-00-05261	1	Threaded Insert
6	2-00-00491	1	Grommet
7	2-00-04742	1	Terminal
8	8-90-07434	1	Wing Wire
9	8-11-00015	2	Terminal
10	2-00-04578	2	Terminal
11	2-00-04626	1	Terminal
12	8-11-00044	1	Cap, Boot
13	8-64-00008	1	Circuit Breaker, 15 amp

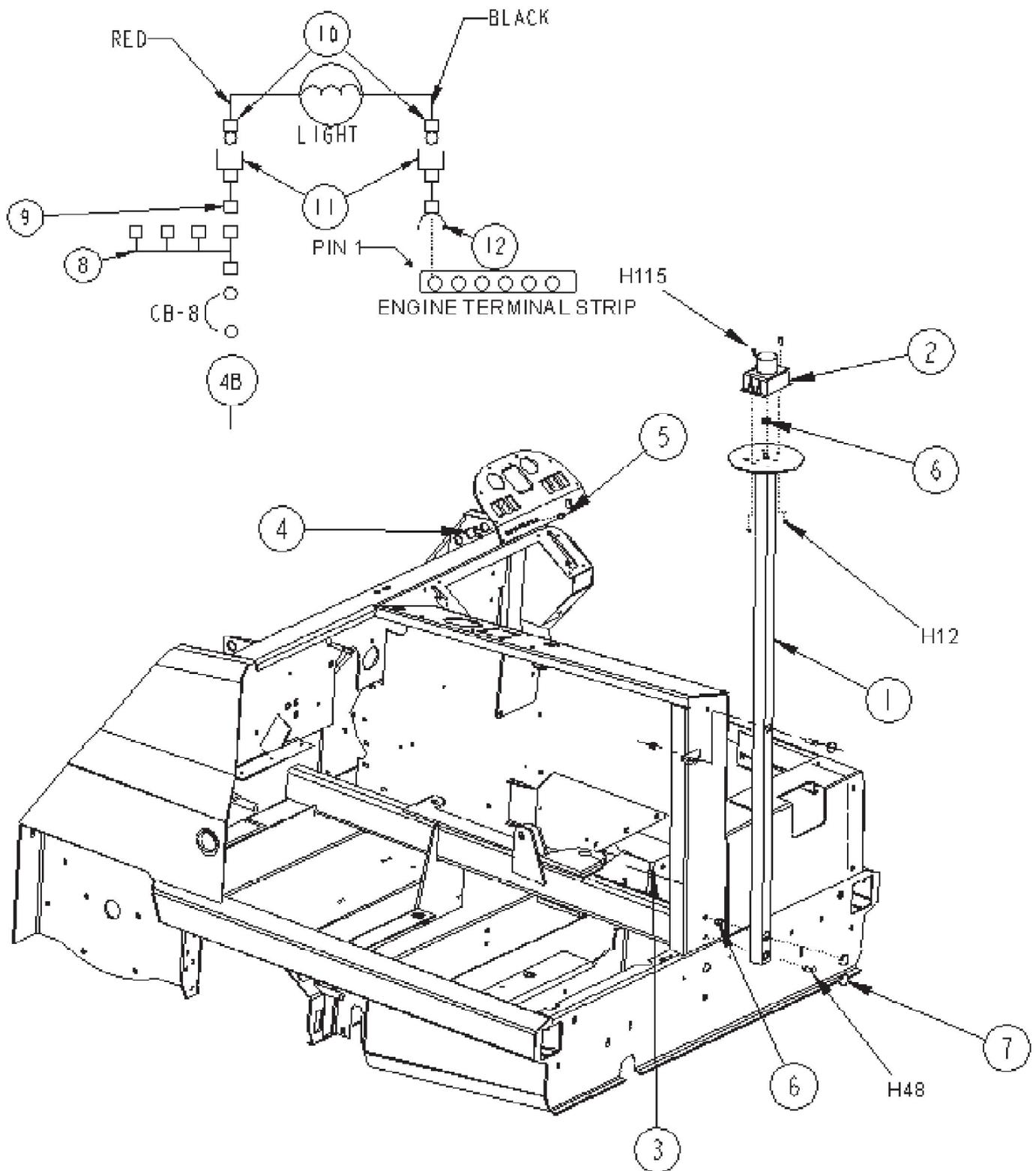

Referenznummer	Artikelnummer	Menge	Description
	0880-598		Amber Strobe Option
	0880-597		Red Strobe Option
1	8-81-00173	1	Light Pole
2	8-40-05036	1	Strobe, Amber
	8-40-05020	1	Strobe, Red
3	2-95-04182	2	Nut, Elastic Stop
4	8-64-00008	1	Circuit Breaker, 15 amp
5	8-11-00044	1	Cap, Instrument Panel Boot
6	2-00-00491	2	Grommet
7	2-00-05134	3	Plug Button
8	8-90-07434	1	Wing Wire
9	8-11-00015	1	Terminal
10	2-00-04578	2	Terminal
11	2-00-04626	2	Terminal
12	2-00-04742	1	Terminal

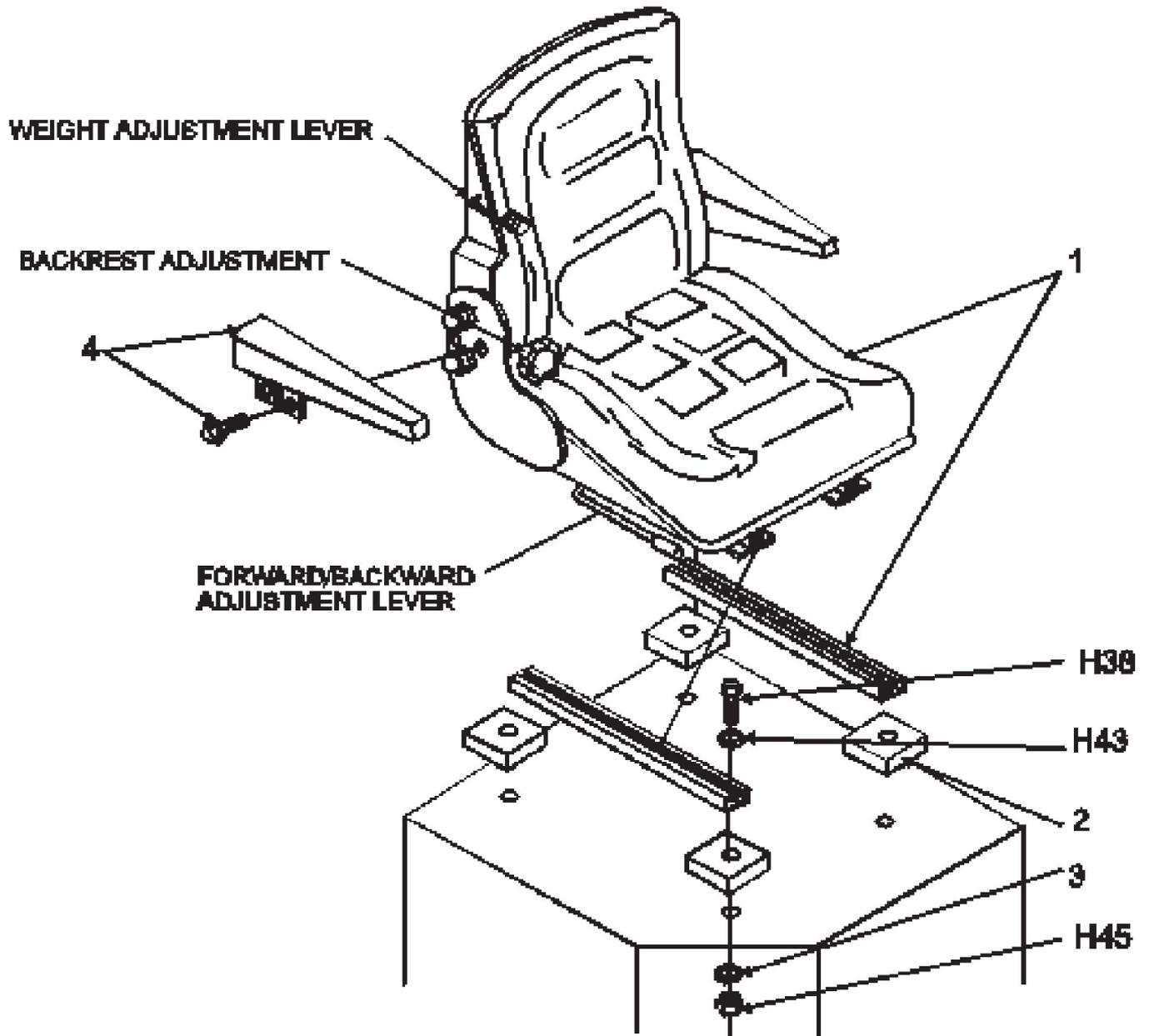

Referenznummer	Artikelnummer	Menge	Description
	0780-146		Suspension Seat Option
1	8-69-00015	1	Seat without Armrests
2	8-71-00016	4	Shim Block
3	2-00-02322	4	Lock Washer, Helical Spring 5/16 Med
4	8-03-04272	1	Armrest Kit (Includes both Armrests)
H38	2-00-00225	4	Screw, 5/16-18 x 1.500 HHC
H43	2-00-00409	4	Flat Washer, .687 x .343 x .062
H45	2-00-00585	4	Nut, 5/16-18 x .500 x .265

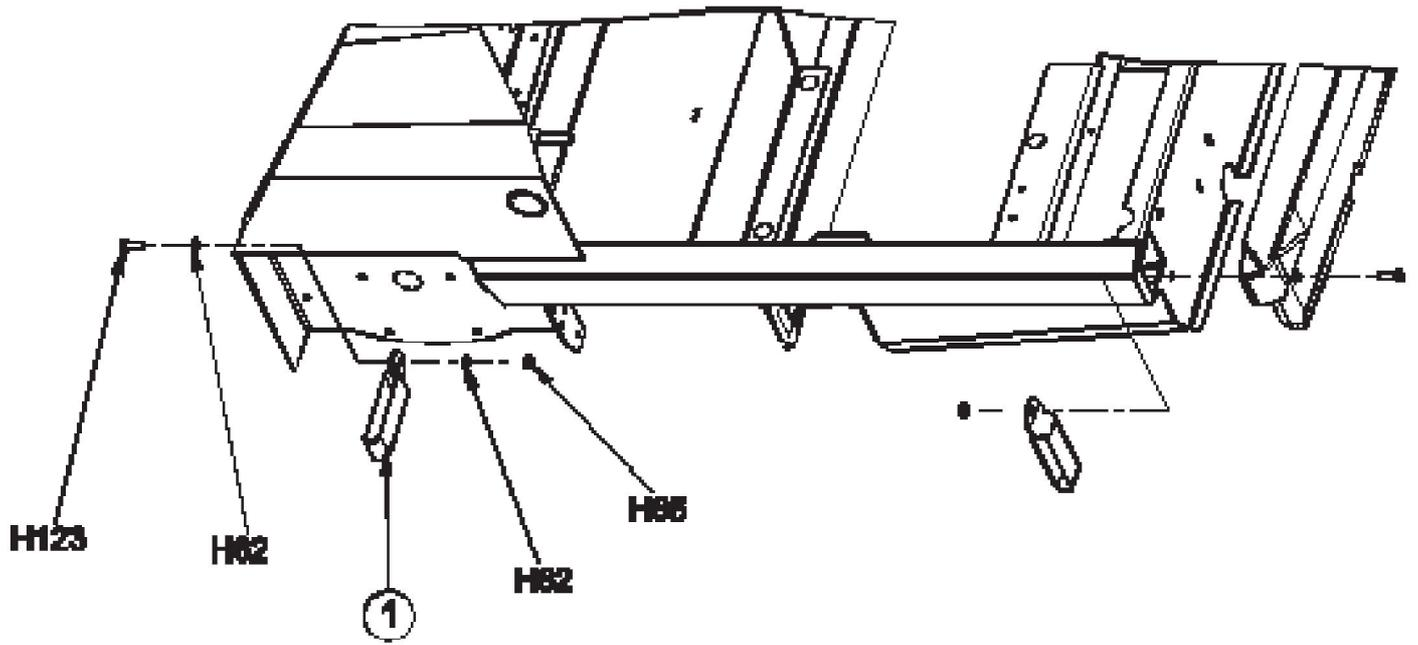

Referenznummer	Artikelnummer	Menge	Description
	0880-618		Tie Down Option
1	8-79-00125	4	Tie Down Strap
H62	2-00-00405	1	Flat Washer, 1.063 x .531 x .094
H65	2-00-04936	1	Nut, 1/2-13 Fibre Lock
H123	2-00-00204	1	Screw, 1/4-20 x 1.500 HHC

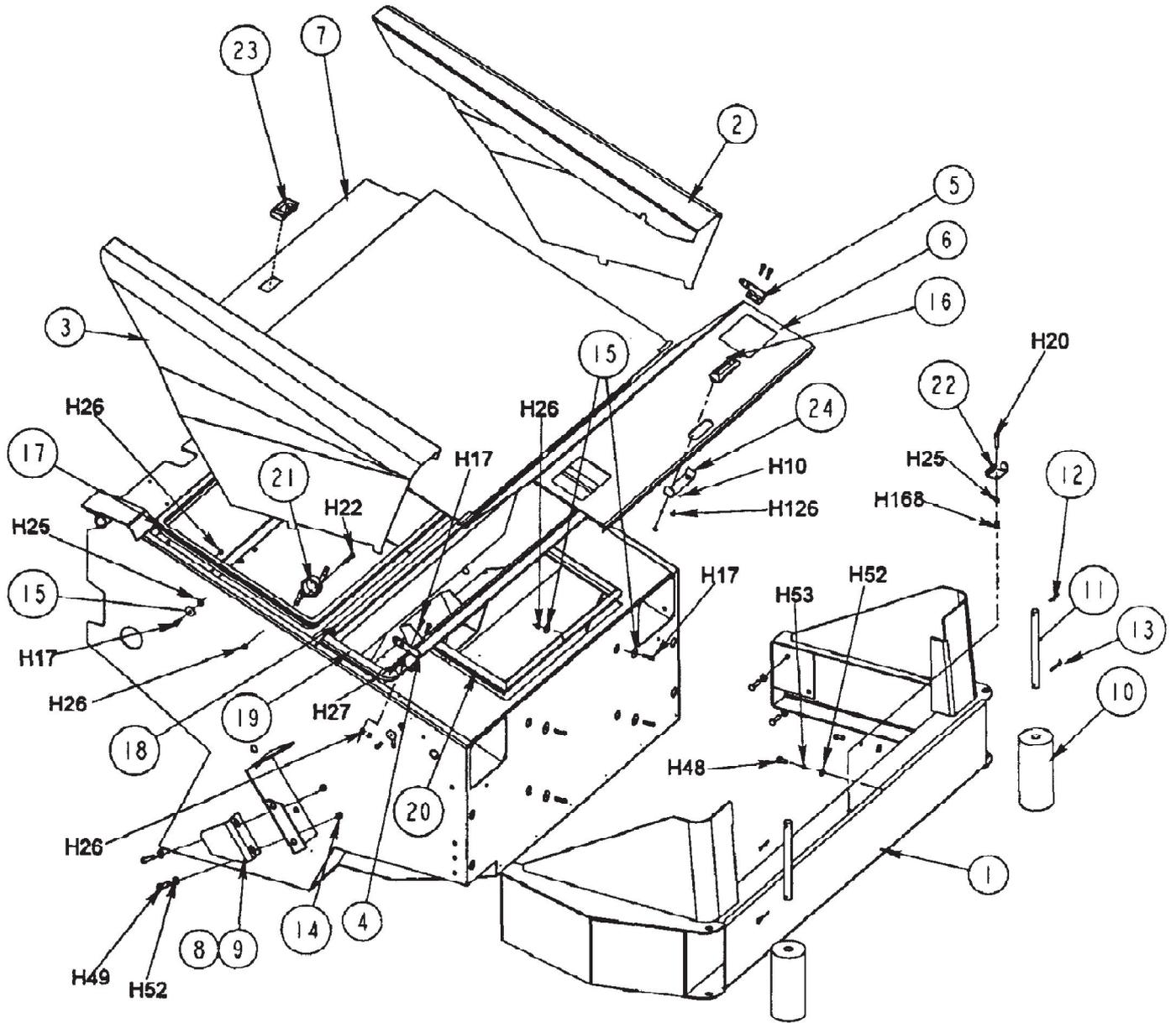

Referenznummer	Artikelnummer	Menge	Description
1	8-08-07063	1	Bumper, Front
2	8-16-07378	1	Side Cover (LH)
3	8-16-07377	1	Side Cover (RH)
4	8-08-00850	1	Bracket (RH)
5	8-08-00851	1	Bracket (LH)
6	8-16-07376	1	Front Cover
7	8-16-07375	1	Top Cover
8	8-08-00852	1	Bracket, Bumper Guide (RH)
9	8-08-00853	1	Bracket, Bumper Guide (LH)
10	8-66-05013	2	Roller Bumper
11	8-70-05304	2	Pin, Roller Bumper
12	2-00-02444	2	Roll Pin, 3/16 x 1.750
13	2-00-02436	2	Cotter Pin
14	2-95-04182	8	Nut, Fibre
15	7-23-0309	12	Washer
16	8-31-06078	1	Handle
17	8-29-00240	1	Gasket
18	8-29-00241	1	Gasket
19	8-29-00243	1	Gasket
20	8-29-00239-1	1	Gasket
21	8-10-00027	1	Cable
22	8-41-00063	1	Latch, Front Cover
23	8-41-00040	1	Latch, Top Cover
24			UNKNOWN
H10	2-00-00519	2	Lock Washer, #10 Med HS Hardware
H17	2-00-00205	8	Screw, 1/4-20 x 1.000 HHC Hardware
H20	2-00-00203	1	Screw, 1/4-20 x 1.500 HHC Hardware
H22	2-00-02589	2	Screw, 1/4-20 x 2.000 HHC Hardware
H25	2-00-00594	5	Nut, Hex 1/4-20 x .437 x .218 Hardware
H26	2-00-00641	12	Nut, 1/4-20 Insert Fiber Hardware
H27	2-00-03702	4	Washer, .625 x .281 x .063 Hardware
H48	2-00-00233	8	Screw, 3/8-16 x 1.000 HHC Hardware
H49	2-00-00209	4	Screw, 3/8-16 x 1.250 HHC Hardware
H52	2-00-00402	12	Flat Washer, .750 x .390 x .094 Hardware
H53	2-00-02310	4	Lock Washer, Helical Spring 3/8 Med. Hardware
H126	2-00-03466	2	Screw, #10-16 x .500 Hardware
H168	2-00-05261	1	Insert, 1/4-20 Hardware

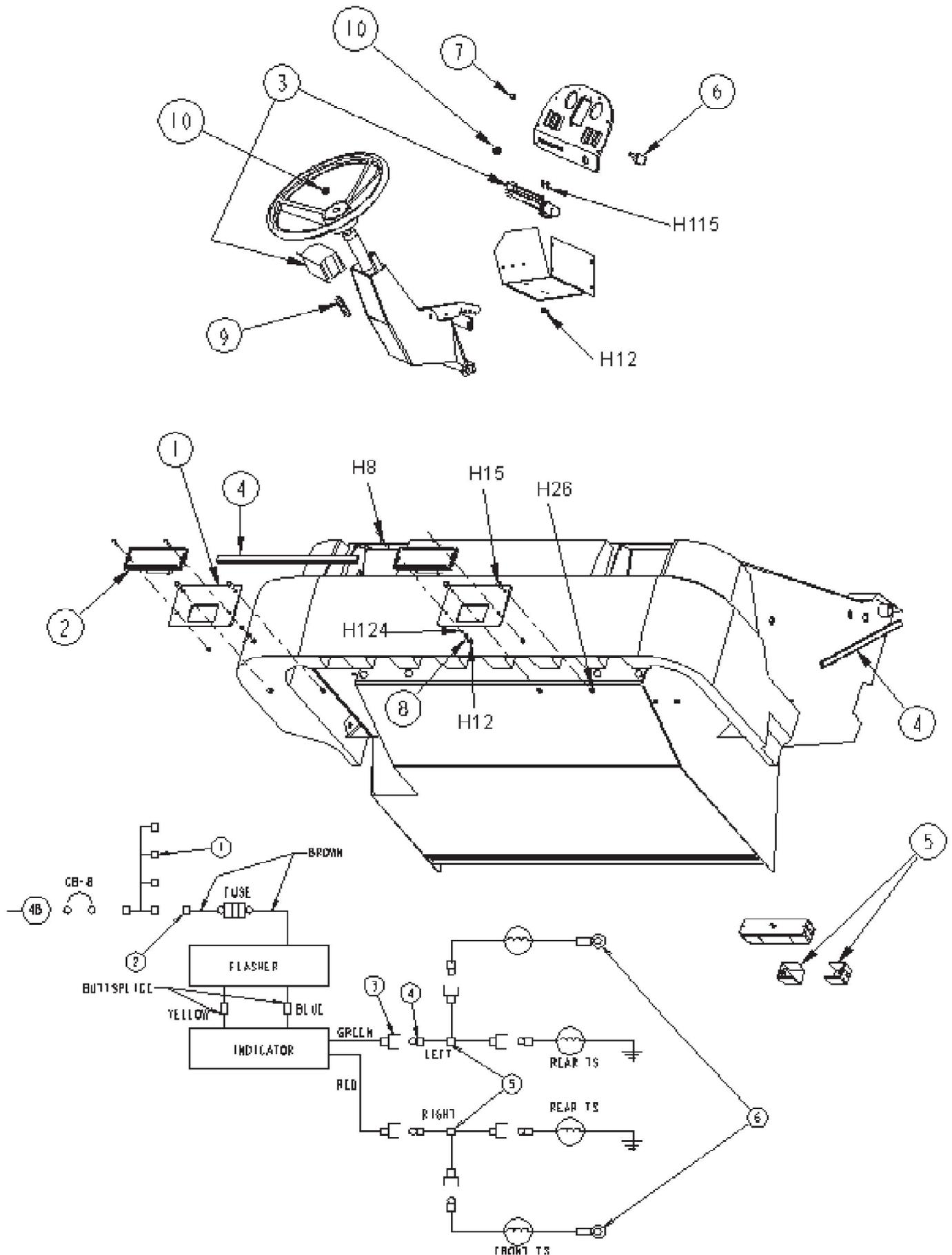

Referenznummer	Artikelnummer	Menge	Description
	0880-596		Turn Signal Option
1	8-08-00820	2	Bracket, Light
2	8-40-05046	2	Turn Light
	2-00-05291	Ref.	Bulb, Turn Signal, Front (Service Part)
	8-41-03012	Ref.	Lens, Turn Signal, Front (Service Part)
3	8-82-00025	1	Turn Signal Switch
4	8-20-06037	2	Duct Wire
5	8-41-03009	2	Lens, Turn Signal
	2-00-05292	Ref.	Bulb, Turn Signal, Rear (Service Part)
6	8-64-00008	1	Circuit Breaker
7	8-11-00044	1	Cap, Instrument Panel Boot
8	2-00-00828	Ref.	Ring Terminal
9	3-61-02014	5	Convolute Tube
10	2-00-00491	2	Grommet
11	8-90-07434	1	Wing Wire
12	8-11-00015	1	Terminal
13	2-00-04626	6	Terminal
14	2-00-04578	6	Terminal
15	2-00-04479	2	Connector
16	2-00-00828	2	Ring Terminal
H8	2-00-00039	4	Screw, 10-24 x 1.000 RHM
H12	2-00-01246	6	Nut, Hex Fiber Insert #10-24
H15	2-00-00221	4	Screw, 1/4-20 x .750 HHC
H26	2-00-00641	4	Nut, 1/4-20 Insert Fiber
H115	2-00-03063	2	Screw, #10-24 x .750 THM
H124	2-00-02296	2	Lock Washer, #10 Ext. Shakeproof

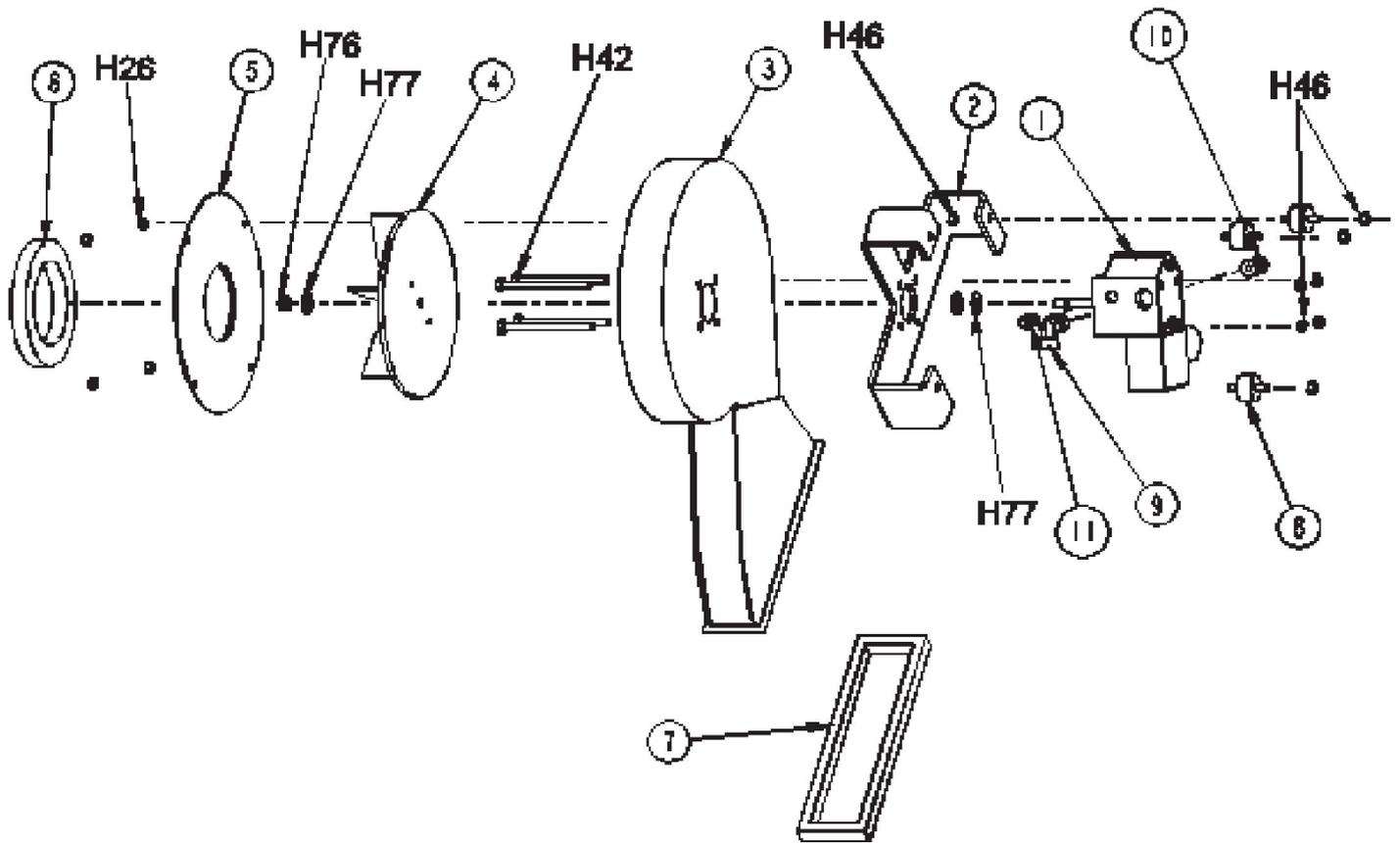

Referenznummer	Artikelnummer	Menge	Description
1	0882-052	1	Vacuum Motor
	7-70-00020		Vacuum Motor Seal Kit Service Part
	7-12-02030		Cartridge Service Part
	7-14-07007		Coil Service Part
2	8-08-00787	1	Bracket, Vacuum Fan
3	8-20-06035	1	Vacuum Fan Exhaust Duct
4	8-23-00012	1	Fan Impellor
5	8-30-05169	1	Guard, Impellor
6	8-29-00183	1	Gasket, Blower
7	8-29-00230	1	Gasket, Blower Exhaust
8	8-50-05037	3	Radiator Mount Pad
9	2-00-04885	1	Fitting, 90ø
10	2-00-04970	1	Fitting, Straight
11	2-00-04895	1	Fitting, Straight
12	0875-117	1	Diode Assembly
H26	2-00-00641	4	Nut, 1/4-20 Insert Fiber
H42	2-00-02655	4	Screw, 5/16-18 x 4.500 HHC
H46	2-00-00644	10	Nut, 5/16-18, Insert Fiber
H76	2-00-00632	1	Nut, Fiber Insert 3/8-24 Steel
H77	2-00-00484	3	Flat Washer, .625 x .375 x .046